



2017

VOREL 



*STHOR*



LUND



FLO 

FALA 



 POWERUP



NEW

Nowość

# POWER UP 79048

HIGH-REVOLUTION POWER  
MOC NA NAJWYŻSZYCH OBROTACH

## HAMMER DRILL

THE STRONGEST SDS-PLUS HAMMER ON THE MARKET WITH POWER OF 1800W AND IMPACT STRENGTH OF UP TO 7 J

- » impact mechanism secured against hot lubricant leakage
- » impact force setting from 2 to 7 J for easy adjustment to material type (hammering of hard concrete, solid bricks and ceramic hollow bricks)
- » high motor power of 1800 W prevents locking of drills longer than 600 mm in the material
- » small device weight enables comfortable directional drilling through ceilings
- » excellent for quick drilling required for installation of junction boxes and creating holes for water supply and sewage pipes and ventilation ducts
- » a tight-fitted metal casing of the electro-pneumatic mechanism ensures system tightness and efficient cooling during prolonged hammering

## MŁOTOWIERTARKA

NAJMOCNIEJSZY NA RYNKU MŁOT SDS-PLUS O MOCY 1800 W I SILE UDERZENIA AŻ 7 J

- » mechanizm uderowy zabezpieczony przed wyciekami rozgrzanego smaru
- » regulowana siła uderu od 2-7 J dla łatwego dopasowania do rodzaju materiału (kucie twardego betonu, cegły pełnej, porotermu)
- » wysoka moc silnika 1800 W zapobiegająca klinowaniu się w materiale wiertła o długości powyżej 600 mm
- » mała waga urządzenia umożliwiająca komfortowe wykonywanie przewiertów w sufitach
- » doskonale sprawdza się przy szybkim wierceniu pod puszkę elektryczną, przekuciach pod rury kanalizacyjne i kanały wentylacyjne
- » dokładnie spasowana metalowa obudowa mechanizmu elektropneumatycznego zapewniająca szczelność układu i wydajne chłodzenie podczas długotrwałego kucia



SDS+

1800  
WIMPACT ENERGY  
UDARU  
2-7J  
ENERGIA0-800 min<sup>-1</sup>0-4000 min<sup>-1</sup>2 YEARS  
WARRANTY



TOYA SA  
ul. Soltysowicka 13-15  
51-168 Wrocław  
☎ (+48 71) 32 46 200  
fax: (+48 71) 32 46 370

sales@yato.pl (sale)  
export@yato.pl (export)  
import@yato.pl (import)

ODDZIAŁ WARSZAWSKI  
Teren ProLogis Park Nadarzyn  
al. Kasztanowa 160  
05-831 Młochów k. Warszawy

☎ (+48 22) 73 82 800  
☎ (+48 22) 73 82 828  
sales@yato.pl (sale)  
export@yato.pl (export)

**1** Spanners  
Klucze

6-13



**2** Sockets, accessories & sets  
Klucze nasadowe, akcesoria i zestawy

14-23



**3** Screwdrivers & screwdriver bits  
Wkrętaki i końcówki wkrętakowe

24-37



**4** Pliers & pipe wrenches  
Szczypce i klucze do rur

38-47



**5** Electrician tools  
Narzędzia dla elektryków

48-53



**6** Hammers, chisels, punches & axes  
Młotki, dłuta, przecinaki i siekiery

54-63



**7** Clamps & vices  
Ściski i imadła

64-69



**8** Cutting tools  
Narzędzia tnące

70-107

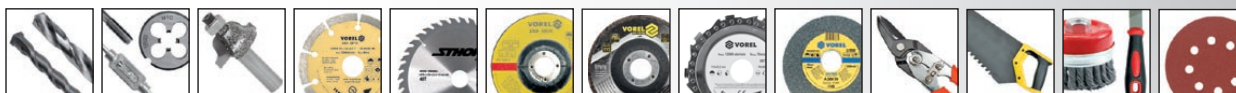

<b>9</b>	<b>Hydraulic tools</b> Narzędzia hydrauliczne	108-115
		
<b>10</b>	<b>Fastening tools</b> Narzędzia do łączenia	116-129
		
<b>11</b>	<b>Plastering &amp; bricklaying tools</b> Narzędzia budowlane i malarskie	130-157
		
<b>12</b>	<b>Measuring tools</b> Narzędzia miernicze	158-167
		
<b>13</b>	<b>Pneumatic tools</b> Narzędzia pneumatyczne	168-179
		
<b>14</b>	<b>Special automotive tools &amp; equipment</b> Narzędzia i wyposażenie warsztatu samochodowego	180-201
		
<b>15</b>	<b>Power tools &amp; accessories</b> Elektronarzędzia i akcesoria	202-235
		
<b>16</b>	<b>Welding equipment</b> Sprzęt spawalniczy	236-243
		

**17 Safes, padlocks & locks** 244-257  
Sejfy, kłódki i zamki



**18 Tool bags & boxes** 258-263  
Torby i skrzynki narzędziowe



**19 Bicycle accessories** 264-271  
Akcesoria rowerowe



**20 Household equipment** 272-297  
Gospodarstwo domowe

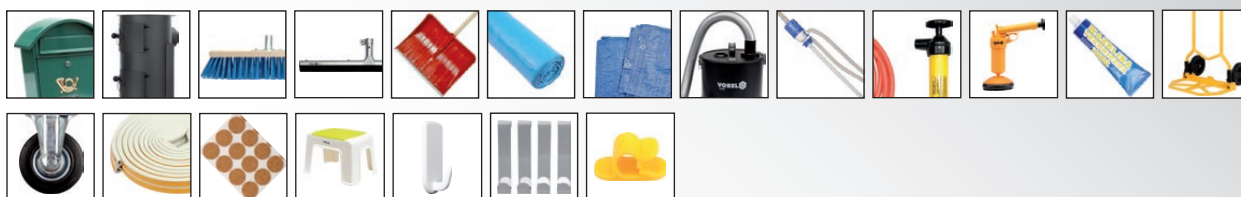

**21 Health & safety products** 298-315  
Artykuły BHP



**22 Electric products** 316-327  
Artykuły elektryczne



**23 Garden tools & power tools** 328-381  
Narzędzia i elektronarzędzia ogrodowe





# 1

## Spanners Klucze





### Combination spanners Klucze płasko-oczkowe

8-9



Combination spanners & sets, polished head  
Klucze płasko-oczkowe i zestawy,  
polerowana główka.....

8

Combination spanners & sets, satin finish CrV  
Klucze płasko-oczkowe i zestawy,  
wykończenie satynowe CrV.....

9

### Combination ratchet wrenches Klucze płasko-oczkowe z grzechotką

10



Combination ratchet wrenches  
Klucze płasko-oczkowe z grzechotką.....

10

Combination ratchet wrench sets  
Zestawy kluczy płasko-oczkowych z grzechotką.....

10

### Double open end spanners Klucze płaskie

10



Double open end spanners & sets, polished head  
Klucze płaskie i zestawy, polerowana główka.....

10

Double open end spanner sets, satin finish CrV  
Zestawy kluczy płaskich,  
wykończenie satynowe CrV.....

10

### Bi-hexagonal ring spanners Klucze oczkowe odgięte

11



Bi-hexagonal ring spanners & sets, polished head  
Klucze oczkowe odgięte i zestawy,  
polerowana główka.....

11

### Swivel socket spanners & sets Klucze nasadowe przegubowe i zestawy

11-12



Open end swivel socket spanners & sets  
Klucze płasko-nasadowe i zestawy.....

11

Double ended swivel socket wrenches  
Klucze nasadowo-przegubowe.....

12

### T-type deep socket wrenches Klucze nasadowe typu „T”

12



### Box end wrenches Klucze rurowe

12



### L-type wrenches Klucze nasadowe typu „L”

12



### Multipipe wrenches Klucze uniwersalne

12



### Double socket ratchet handles Dwustronne klucze nasadkowe z grzechotką

12



### Adjustable wrenches Klucze nastawne

13



### Torque wrenches Klucze dynamometryczne

13



1

- PL Klucz plasko-oczkowy  
 GB Combination spanner  
 D Maulringschlüssel  
 RUS Ключ комбинированный
- CZ Plochý a očkový klíč  
 RO Cheie combinata  
 H Kulcs villás-csillag  
 E Combinada con llave de estrella



No.	mm	pcs	box
51060	6	200/1200	
51070	7	200/1000	
51080	8	100/600	
51090	9	50/600	
51100	10	50/600	
51110	11	50/400	
51120	12	50/400	
51130	13	50/400	
51140	14	50/300	
51150	15	50/300	
51160	16	50/200	
51170	17	20/200	
51180	18	25/200	
51190	19	30/120	
51200	20	20/160	
51210	21	20/120	
51220	22	30/120	
51240	24	15/90	
51270	27	10/60	
51300	30	10/40	
51320	32	10/40	

- PL Komplet kluczy plasko-oczkowych  
 GB Combination spanner set  
 D Maulringschlüsselsatz  
 RUS Набор комбинированных ключей
- CZ Souprava plochých a očkových klíčů  
 RO Set chei combinata  
 H Kulcskészlet villás-csillag clip  
 E Juego de combinadas con llave de estrella



No.	mm	pcs	box
50850	8; 10; 12; 13; 14; 17	6	4/40
50861	6; 8; 10; 13; 14; 17; 19; 22	8	4/32
50871	6; 7; 8; 9; 10; 11; 12; 13; 14; 17; 19; 22	12	2/20

- PL Komplet kluczy plasko-oczkowych  
 GB Combination spanner set  
 D Maulringschlüsselsatz  
 RUS Набор комбинированных ключей
- CZ Souprava plochých a očkových klíčů  
 RO Set chei combinata  
 H Kulcskészlet villás-csillag clip  
 E Juego de combinadas con llave de estrella



No.	mm	pcs	box
51560	8; 10; 12; 13; 14; 17	6	15/60
51590	6; 8; 10; 12; 13; 14; 17; 19	8	10/40
51630	6; 7; 8; 9; 10; 11; 12; 13; 14; 17; 19; 22	12	5/20
51640	6; 7; 8; 9; 10; 11; 12; 13; 14; 17; 19; 21; 24; 27; 32	15	2/12
51645	6; 7; 8; 9; 10; 11; 12; 13; 14; 15; 16; 17; 18; 19; 21; 22; 24; 27; 30; 32	20	8

- PL Komplet kluczy plasko-oczkowych  
 GB Combination spanner set  
 D Maulringschlüsselsatz  
 RUS Набор комбинированных ключей
- CZ Souprava plochých a očkových klíčů  
 RO Set chei combinata  
 H Kulcskészlet villás-csillag clip  
 E Juego de combinadas con llave de estrella



No.	mm	pcs	box
51580	6; 8; 10; 11; 13; 14; 17; 19	8	5/50
51620	6; 7; 8; 9; 10; 11; 12; 13; 14; 17; 19; 22	12	5/20
51650	6; 7; 8; 9; 10; 11; 12; 13; 14; 15; 16; 17; 18; 19; 20; 21; 22; 23; 24; 25; 26; 27; 28; 30; 32	25	4

- PL Komplet kluczy plasko-oczkowych  
 GB Combination spanner set  
 D Maulringschlüsselsatz  
 RUS Набор комбинированных ключей
- CZ Souprava plochých a očkových klíčů  
 RO Set chei combinata  
 H Kulcskészlet villás-csillag clip  
 E Juego de combinadas con llave de estrella



No.	size / rozmiar	pcs	box
50880	1/4" (6.3 mm); 5/16" (7.9 mm); 3/8" (9.5 mm); 7/16" (11.1 mm); 1/2" (12.7 mm); 9/16" (14.3 mm); 5/8" (15.9 mm); 11/16" (17.5 mm); 3/4" (19.0 mm)	9	10

PL Klucz plasko-oczkowy  
GB Combination spanner  
D Maulringschlüssel  
RUS Ключ комбинированный

CZ Plochý a očkový klíč  
RO Cheie combinata  
H Kulcs villás-csillag  
E Combinada con llave de estrella



No.	mm	
51671	6	20/400
51672	7	20/400
51673	8	20/400
51674	9	20/400
51675	10	20/320
51676	11	20/240
51677	12	20/240
51678	13	20/200
51679	14	20/200
51680	15	20/200
51681	16	20/200
51682	17	20/160
51683	18	20/160
51684	19	20/160
51685	20	20/120
51686	21	20/120
51687	22	20/120
51688	23	10/80
51689	24	10/80
51690	25	10/60
51691	26	10/40
51692	27	10/40
51693	28	10/40
51694	29	10/40
51695	30	10/40
51696	32	10/40

PL Komplet kluczy plasko-oczkowych  
GB Combination spanner set  
D Maulringschlüsselsatz  
RUS Набор комбинированных ключей

CZ Souprava plochých a očkových klíčů  
RO Set chei combinata  
H Kulcskészlet villás-csillag  
E Juego de combinadas con llave de estrella

12  
PCS

CrV



No.	mm	pcs	
51710	6; 8; 10; 11; 12; 13; 14; 15; 17; 18; 19; 22	12	20

PL Komplet kluczy plasko-oczkowych  
GB Combination spanner set  
D Maulringschlüsselsatz  
RUS Набор комбинированных ключей

CZ Souprava plochých a očkových klíčů  
RO Set chei combinata  
H Kulcskészlet villás-csillag clip  
E Juego de combinadas con llave de estrella

CrV



No.	mm	pcs	
51720	8; 10; 12; 13; 14; 17	6	4/40
51721	6; 8; 10; 12; 13; 14; 17; 19	8	4/32
51722	6; 7; 8; 9; 10; 11; 12; 13; 14; 17; 19; 22	12	2/20

PL Komplet kluczy plasko-oczkowych  
GB Combination spanner set  
D Maulringschlüsselsatz  
RUS Набор комбинированных ключей

CZ Souprava plochých a očkových klíčů  
RO Set chei combinata  
H Kulcskészlet villás-csillag  
E Juego de combinadas con llave de estrella

8  
PCS

CrV



No.	mm	pcs	
51705	8; 10; 12; 13; 14; 15; 17; 19	8	30

PL Komplet kluczy plasko-oczkowych  
GB Combination spanner set  
D Maulringschlüsselsatz  
RUS Набор комбинированных ключей

CZ Souprava plochých a očkových klíčů  
RO Set chei combinata  
H Kulcskészlet villás-csillag  
E Juego de combinadas con llave de estrella

25  
PCS

CrV



No.	mm	pcs	
51715	6; 7; 8; 9; 10; 11; 12; 13; 14; 15; 16; 17; 18; 19; 20; 21; 22; 23; 24; 25; 26; 27; 28; 30; 32	25	4

1

- PL Klucz płasko-oczkowy z grzechotką  
 GB Combination ratchet wrench  
 D Ratschenringmaulschlüssel  
 RUS Ключ комбинированный с трещоткой  
 CZ Klíč očkoložný ráčnový  
 RO Cheie combinata cu crichet  
 H Csillag-villás kulcs racsnis  
 E Llave combinada fija abierta y carraca



VOREL

No.	mm	
52652	10	10/100
52653	11	10/100
52654	12	10/100
52655	13	10/100
52656	14	10/100
52657	15	10/100
52658	17	10/50
52659	19	10/50
52660	22	10/40

- PL Klucz płaski  
 GB Double open end spanner  
 D Doppelmaulschlüssel  
 RUS Ключ рожковый
- CZ Ploché klíč  
 RO Set chei fixa  
 H Villáskulcs  
 E Llave fija



No.	mm	
50070	6x7	100/1000
50090	8x9	60/600
50100	8x10	60/600
50110	10x11	60/600
50120	10x13	50/500
50130	12x13	50/500
50150	14x15	50/300
50170	13x17	50/300
50190	17x19	30/180
50220	19x22	30/180
50270	24x27	25/100
50330	30x32	15/60

- PL Komplet kluczy płaskich  
 GB Double open end spanner set  
 D Doppelmaulschlüsselsatz  
 RUS Набор ключей рожковых
- CZ Souprava plochých klíčů  
 RO Set chei fixe  
 H Kulcskészlet, villás  
 E Juego de llaves fijas



No.	mm	pcs	
50580	6x7; 8x9; 10x11; 12x13; 14x15; 16x17; 18x19; 20x22	8	10/40
50620	6x7; 8x9; 10x11; 12x13; 14x15; 16x17; 18x19; 20x22; 21x23; 24x26; 25x28; 27x32	12	5/15

- PL Zestaw kluczy płasko-oczkowych z grzechotką  
 GB Combination ratchet wrench set  
 D Ratschenringmaulschlüssel-satz  
 RUS Набор комбинированных ключей с трещоткой  
 CZ Klíče ráčnové sada  
 RO Set chei combinata  
 H Racsnis csillag-villás kulcs készlet  
 E Juego de llaves planas con matraca



VOREL

No.	mm	pcs	
52661	10; 13; 17; 19	4	10/20

- PL Komplet kluczy płaskich  
 GB Double open end spanner set  
 D Doppelmaulschlüsselsatz  
 RUS Набор ключей рожковых
- CZ Souprava plochých klíčů  
 RO Set chei fixe  
 H Kulcskészlet, villás  
 E Juego de llaves fijas



No.	mm	pcs	
50560	6x7; 8x9; 10x11; 12x13; 14x15; 16x17	6	20/80
50590	6x7; 8x9; 10x11; 12x13; 14x15; 16x17; 18x19; 20x22	8	10/40
50610	6x7; 8x9; 10x11; 12x13; 14x15; 16x17; 18x19; 20x22; 24x27; 30x32	10	5/20
50630	6x7; 8x9; 10x11; 12x13; 14x15; 16x17; 18x19; 20x22; 21x23; 24x26; 25x28; 27x32	12	5/15

- PL Komplet kluczy płaskich  
 GB Double open end spanner set  
 D Doppelmaulschlüsselsatz  
 RUS Набор ключей рожковых
- CZ Souprava plochých klíčů  
 RO Set chei fixe  
 H Kulcskészlet, villás  
 E Juego de llaves fijas



VOREL

No.	mm	pcs	
51740	6x7; 8x9; 10x11; 12x13; 14x15; 16x17	6	4/40
51741	6x7; 8x9; 10x11; 12x13; 14x15; 16x17; 18x19; 20x22	8	4/24

PL Klucz oczkowy odgięty  
GB Bi-hexagonal ring spanner  
D Doppelringschlüssel  
RUS Ключ накидной изогнутый

CZ Očkový klíč ohnutý  
RO Cheie inelaro-curbată  
H Hajlítótszárú csillagkulcs  
E Llave de estrella



No.	mm	
52100	8x10	50/300
52110	10x11	50/300
52120	10x13	50/200
52130	12x13	50/200
52170	13x17	30/120
52190	17x19	25/100
52220	19x22	20/80
52270	24x27	10/60
52340	30x32	5/40

PL Klucz płasko-nasadowy, przegubowy  
GB Open end swivel head socket wrench  
D Maul-steckschlüssel  
RUS Ключ рожково-торцевой с шарниром

CZ Klic nasad. ploch.  
RO Cheie fixe-tubulare  
H Kulcs villás-dugó  
E Combinada con vaso



No.	mm	
52680	8	20/200
52700	10	20/200
52710	11	20/200
52720	12	20/200
52730	13	20/200
52740	14	20/200
52750	15	25/100
52770	17	25/100
52790	19	25/50
52820	22	25/50

PL Klucz płasko-nasadowy, przegubowy  
GB Open end swivel head socket wrench  
D Maul-steckschlüssel  
RUS Ключ рожково-торцевой с шарниром

CZ Klic nasad. ploch.  
RO Cheie fixe-tubulare  
H Kulcs villás-dugó  
E Combinada con vaso

CrV  
40



**VOREL**

No.	mm	pcs packing	
52840	8	10	200
52841	10	10	200
52842	11	10	160
52843	12	10	160
52844	13	10	160
52845	14	10	160
52846	17	10	100
52847	19	10	80

PL Komplet kluczy oczkowych odgiętych  
GB Bi-hexagonal ring spanner set  
D Doppelringschlüsselsatz  
RUS Набор ключей накидных изогнутых

CZ Klíče očkové vyhnuté sada  
RO Set chei inelare cu cot  
H Csillagkulcs készlet  
E Juego de llaves de estrella acodadas



1

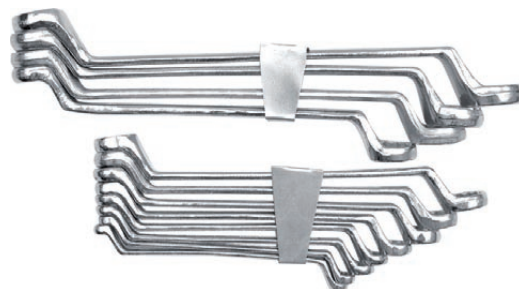

No.	mm	pcs	
52560	6x7; 8x9; 10x11; 12x13; 14x15; 16x17	6	6/36
52570	6x7; 8x9; 10x11; 12x13; 14x15; 16x17; 18x19; 20x22	8	5/20
52630	6x7; 8x9; 10x11; 12x13; 14x15; 16x17; 18x19; 20x21; 22x23; 24x25; 26x27; 28x32	12	2/8

PL Komplet kluczy oczkowych odgiętych  
GB Bi-hexagonal ring spanner set  
D Doppelringschlüsselsatz  
RUS Набор ключей накидных изогнутых

CZ Klíče očkové vyhnuté sada  
RO Set chei inelare cu cot  
H Csillagkulcs készlet  
E Juego de llaves de estrella acodadas

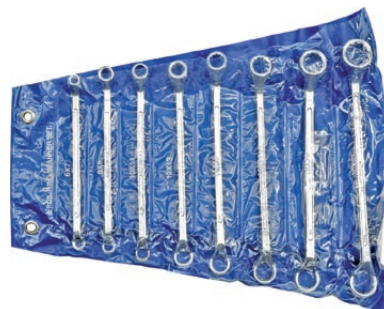

No.	mm	pcs	
52580	6x7; 8x9; 10x11; 12x13; 14x15; 16x17; 18x19; 20x22	8	5/20

PL Komplet kluczy płasko-nasadowych  
GB Open end swivel head socket wrench set  
D Gabel-Gelenk-Steckschlüsselsatz  
RUS Набор ключей рожково-торцевых с шарниром  
CZ Ploché nástrčné klíče kloubové  
RO Cheie plato-tubulare cu articulatie  
H Kulcs villás-csuklós dugó  
E Combinadas con vaso articulado

6  
PCS



No.	mm	pcs	
52860	10; 11; 13; 14; 17; 19	6	6/24

1

- PL Klucz nasadowy, przegubowy  
 GB Double flexible socket wrench  
 D Steckschlüssel, mit Gelenk  
 RUS Ключ торцевой шарнирный
- CZ Klíč nástrčný s kloubem  
 RO Cheie fixa, articulata  
 H Dugókulcs, csuklós  
 E Llave de cubo articulada



No.	mm	pcs packing	☐
52850	8x9	10	200
52851	10x11	10	200
52852	12x13	10	150
52853	14x15	10	100
52854	16x17	10	100
52855	18x19	10	80

- PL Komplet kluczy rurowych  
 GB Tubular socket wrench set  
 D Rohrsteckschlüsselsatz  
 RUS Набор ключей трубчатых
- CZ Klíče trubkové  
 RO Chei pt. țevi  
 H Csőkulcs  
 E Llaves de tuberia



No.	mm	pcs	☐
52900	6-22	10	6/24

- PL Klucze uniwersalne  
 GB Multipipe wrenches  
 D Universalschlüssel  
 RUS Ключи универсальные
- CZ Univerzální klíče  
 RO Chei universale  
 H Univerzális kulcs  
 E Juego de llaves universales



No.	mm	pcs	☐
54000	9-32	2	20/40

- PL Klucz nasadowy typu „T”  
 GB T-type socket wrench  
 D T-Griff-Steckschlüssel  
 RUS Ключ торцевой Т-образный
- CZ Čepový a nástrčný klíč  
 RO Cheie tubulara tip „T”  
 H Kulcs, csap-dugó  
 E Llave mandril vaso



No.	L (mm)	mm	☐
56710	380	8	50
56720	380	10	50
56730	380	13	50
56740	380	17	50
56750	380	19	50
56770	190	8	50
56780	190	10	50
56790	190	13	50

- PL Klucz nasadowy typu „L”  
 GB L-type socket wrench  
 D Steckschlüssel gebogen  
 RUS Ключ торцевой L-типа
- CZ Nástrčný klíč fajfkový  
 RO Cheie tubulara cu cot tip „L”  
 H Kulcs, dugó-pipa  
 E Llave de vaso „L”



No.	mm	☐
54600	6	20/240
54610	7	20/240
54620	8	20/240
54630	9	20/240
54640	10	20/240
54650	11	20/200
54660	12	20/200
54670	13	20/200
54680	14	10/100
54690	15	10/100
54700	16	10/100
54710	17	10/80
54720	18	10/80
54730	19	10/80
54750	21	10/60
54760	22	10/60
54780	24	10/40
54860	32	8/16

- PL Klucze rurowe  
 GB Double ratchet wrench  
 D Gerüstratsche  
 RUS Ключ торцевой с трещоткой
- CZ Ráčnový klíč průchozí dvoustranný  
 RO Cheie tubulara dubla cu clichet  
 H Kettős racsnis kulcs  
 E Llave de vaso con carraca



No.	mm	☐
52932	13x15	2/40
52933	14x17	2/40
52935	17x19	2/40
52936	19x22	2/40

PL Klucz nastawny  
GB Adjustable wrench  
D Rollgabelschlüssel  
RUS Ключ разводной

CZ Nastavitelný klíč  
RO Cheie reglabilă  
H Állítható  
E Llave ajustable



No.	L (mm)	
54034	300	6/24

PL Klucz nastawny  
GB Adjustable wrench  
D Rollgabelschlüssel  
RUS Ключ разводной

CZ Nastavitelný klíč  
RO Cheie reglabilă  
H Állítható  
E Llave ajustable



No.	L (mm)	
54065	150	6/120
54066	200	6/60
54067	250	6/36
54068	300	6/24

PL Klucz dynamometryczny wychylny  
GB Torque wrench  
D Drehmomentschlüssel  
RUS Ключ динамометрический стрелочный  
CZ Dynamometrický klíč  
RO Cheie cu dinamometru  
H Nyomatékkulcs  
E Llave dinamometrico inclin.

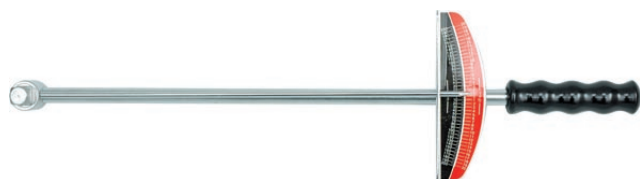

No.	size / rozmiar	
57450	1/2" (12.7 mm)	6/24

PL Klucz nastawny  
GB Adjustable wrench  
D Rollgabelschlüssel  
RUS Ключ разводной

CZ Nastavitelný klíč  
RO Cheie reglabilă  
H Állítható  
E Llave ajustable



No.	L (mm)	
54061	200	6/60
54062	250	6/36
54063	300	6/24

PL Klucz nastawny  
GB Adjustable wrench  
D Rollgabelschlüssel  
RUS Ключ разводной

CZ Nastavitelný klíč  
RO Cheie reglabilă  
H Állítható  
E Llave ajustable



No.	L (mm)	
54070	150	6/120
54071	200	6/60
54072	250	6/36
54073	300	6/24

PL Klucz dynamometryczny  
GB Torque wrench  
D Drehmomentschlüssel  
RUS Ключ динамометрический

CZ Dynamometrický klíč  
RO Cheie cu dinamometru  
H Nyomatékkulcs  
E Llave dinamometrico



No.	size / rozmiar	L (mm)	Nm	packing	
57300	3/8" (9.5 mm)	270	13.6 - 108		20
57350	1/2" (12.7 mm)	465	28.0 - 210		10
57400	3/4" (19.0 mm)	625	68.0 - 406		10

# 2

## Sockets, accessories & sets Klucze nasadowe, akcesoria i zestawy





## Sockets Klucze nasadowe



16

**Hexagonal sockets 1/2"**  
Klucze nasadowe sześciokątne 1/2"..... 16

**Hexagonal sockets 3/4"**  
Klucze nasadowe sześciokątne 3/4"..... 16

## Accessories Akcesoria



16-17

**Extension bars**  
Przedłużki..... 16

**Adapters**  
Redukcje..... 16

**Universal joints**  
Przeguby Cardana..... 16

**Sliding T-bars**  
Pokręta typu „T”..... 16

**Speed braces**  
Rękojeści wygięte..... 17

## Ratchet handles Grzechotki



17

## Socket & tool sets Zestawy kluczy nasadowych i narzędziowych



17-23

**Socket sets 1/4"**  
Zestawy kluczy nasadowych 1/4"..... 17

**Socket sets 3/8"**  
Zestawy kluczy nasadowych 3/8"..... 18

**Socket sets 1/2"**  
Zestawy kluczy nasadowych 1/2"..... 18

**Socket sets 3/4"**  
Zestawy kluczy nasadowych 3/4"..... 19

**Tool sets**  
Zestawy narzędziowe..... 19

2

PL Nasadka sześciokątna  
GB Hexagonal socket  
D Sechskantenschlüssel  
RUS Торцевая головка 6-гранная

CZ Šestihřanný nástavec  
RO Cheie tubulară hexagonală  
H Hatszögű rátét  
E Boquilla hexagonal corta

1/2"  
12.5mm



No.	mm	size / rozmiar	
53080	8	1/2" (12.7 mm)	150/300
53100	10	1/2" (12.7 mm)	150/300
53120	12	1/2" (12.7 mm)	150/300
53130	13	1/2" (12.7 mm)	150/300
53140	14	1/2" (12.7 mm)	150/300
53150	15	1/2" (12.7 mm)	150/300
53160	16	1/2" (12.7 mm)	150/300
53170	17	1/2" (12.7 mm)	125/250
53180	18	1/2" (12.7 mm)	100/200
53190	19	1/2" (12.7 mm)	100/200
53210	21	1/2" (12.7 mm)	75/150
53220	22	1/2" (12.7 mm)	75/150
53240	24	1/2" (12.7 mm)	50/100
53270	27	1/2" (12.7 mm)	50/100
53300	30	1/2" (12.7 mm)	40/80
53320	32	1/2" (12.7 mm)	40/80

PL Przedłużka  
GB Extension bar  
D Verlängerung  
RUS Удлинитель для воротка

CZ Prodlužovací přípravek  
RO Prelungitor  
H Hosszabító  
E Tubo de prolongación



No.	size / rozmiar	L (mm)	
53610	1/2" (12.7 mm)	125	50/100
53630	1/2" (12.7 mm)	250	25/50

**VOREL**

No.	size / rozmiar	L (mm)	
53650	3/4" (19.0 mm)	100	60
53670	3/4" (19.0 mm)	200	25

PL Przegub Cardana  
GB Universal joint  
D Kardangelenk  
RUS Карданный шарнир

CZ Kardanový kloub  
RO Articulație Cardanică  
H Kardán csukló  
E Articulación Cardan



No.	size / rozmiar	
53598	1/4" (6.3 mm)	150/300
53599	3/8" (9.5 mm)	100/200
53600	1/2" (12.7 mm)	60/120

PL Nasadka sześciokątna  
GB Hexagonal socket  
D Sechskantenschlüssel  
RUS Торцевая головка 6-гранная

CZ Šestihřanný nástavec  
RO Cheie tubulară hexagonală  
H Hatszögű rátét  
E Boquilla hexagonal corta

3/4"  
19mm



No.	mm	size / rozmiar	
53400	22	3/4" (19.0 mm)	50
53410	24	3/4" (19.0 mm)	50
53420	27	3/4" (19.0 mm)	50
53430	30	3/4" (19.0 mm)	50
53440	32	3/4" (19.0 mm)	50
53450	36	3/4" (19.0 mm)	50
53460	38	3/4" (19.0 mm)	40
53470	41	3/4" (19.0 mm)	25
53480	46	3/4" (19.0 mm)	20
53490	50	3/4" (19.0 mm)	20

PL Redukcja  
GB Adapter  
D Reduktion  
RUS Переходник

CZ Redukce  
RO Reducție  
H Redukció  
E Reducción



No.	size / rozmiar	
53760	3/8" (9.5 mm) - 1/4" (6.3 mm)	120/240

PL Pokrętko typu „T”  
GB Sliding t-bar  
D Handgriff mit gleitstück  
RUS Вороток для торцевых головок Т-образный

CZ Otočná račka typ „T”  
RO Mâner clupă tipul „T”  
H „T” alakú hajtókar  
E Mango tipo „T”



No.	size / rozmiar	L (mm)	
53700	1/2" (12.7 mm)	250	25/50

**VOREL**

No.	size / rozmiar	L (mm)	
53710	3/4" (19.0 mm)	450	20

PL Rękojeść wygięta  
GB Speed brace  
D Kurbelverlängerung  
RUS Вороток-колыворот

CZ Ohnutá rukojeť  
RO Mâner curbat (manivelă)  
H Hajlított markolat /korba/  
E Mango encorvado /manivela/



No.	size / rozmiar	L (mm)	
53730	1/2" (12.7 mm)	400	40

PL Grzechotka  
GB Ratchet handle  
D Hebelumschaltknarre  
RUS Трещотка для торцевых головок

CZ Řehtačka  
RO Antrenor cu clichet  
H Racsní  
E Llave de carraca



No.	size / rozmiar	L (mm)	
53561	1/4" (6.3 mm)	135	40/80
53562	3/8" (9.5 mm)	190	25/50
53563	1/2" (12.7 mm)	240	20/40

PL Grzechotka  
GB Ratchet handle  
D Hebelumschaltknarre  
RUS Трещотка с изогнутой ручкой

CZ Řehtačka  
RO Antrenor cu clichet  
H Racsní  
E Llave de carraca



No.	size / rozmiar	L (mm)	teeth / zęby	
53571	1/4" (6.3 mm)	150	72	6/36
53572	3/8" (9.5 mm)	200	72	6/36
53573	1/2" (12.7 mm)	260	72	6/36

PL Grzechotka  
GB Ratchet handle  
D Hebelumschaltknarre  
RUS Трещотка для торцевых головок

CZ Řehtačka  
RO Antrenor cu clichet  
H Racsní  
E Llave de carraca



No.	size / rozmiar	L (mm)	
53580	3/4" (19.0 mm)	500	10

PL Grzechotka  
GB Ratchet handle  
D Hebelumschaltknarre  
RUS Трещотка для торцевых головок

CZ Řehtačka  
RO Antrenor cu clichet  
H Racsní  
E Llave de carraca



No.	size / rozmiar	L (mm)	
53500	1/4" (6.3 mm)	125	40/80
53520	3/8" (9.5 mm)	195	25/50
53540	1/2" (12.7 mm)	250	20/40

PL Grzechotka przegubowa  
GB Flexible ratchet handle  
D Gelenk-Hebelumschaltknarre  
RUS Трещотка шарнирная

CZ Kloubová řehtačka  
RO Antrenor cu clichet, flexibil  
H Csuklós racsní  
E Llave de carraca articulada



No.	size / rozmiar	L (mm)	
53560	1/2" (12.7 mm)	250	25/50

PL Grzechotka  
GB Ratchet handle  
D Hebelumschaltknarre  
RUS Трещотка с пластиковым покрытием

CZ Řehtačka  
RO Antrenor cu clichet  
H Racsní  
E Llave de carraca



No.	size / rozmiar	L (mm)	teeth / zęby	
53575	1/4" (6.3 mm)	155	72	12/72
53576	3/8" (9.5 mm)	200	72	6/48
53577	1/2" (12.7 mm)	250	72	6/36

PL Komplet nasadek z akcesoriami  
GB Socket set  
D Sechskantenschlüssel-Einsatz  
RUS Набор торцевых головок

CZ Sada nástrčných kľúčů a ráčny  
RO Trusă de chei tubulare cu antrenor  
H Dugókulcs készlet racsnis hajtókarral  
E Juego de boquillas con accesorios



⊕ 1/4" (6.3 mm) x 120 mm;  
⊕ 1/4" (6.3 mm) x 50 mm;  
⊙ 1/4" (6.3 mm): 4, 4.5, 5, 5.5, 6, 6.5, 7, 8, 9, 10, 11, 12, 13 mm;  
⊙ 1/4" (6.3 mm)

No.	pcs	
58160	16	20

- PL Komplet nasadek z akcesoriami  
 GB Socket set  
 D Sechskantenschlüssel-Einsatz  
 RUS Набор торцевых головок
- CZ Sada nástrčných kľúčů a ráčny  
 RO Trusă chei tubulare cu antrenor  
 H Dugókulcs készlet racsnis hajtókkal  
 E Juego de boquillas con accesorios

20  
PCS



⊕ 3/8" (9.5 mm) x 190 mm; ⊕ 1/4" (6.3 mm) x 50 mm; ⊕ 3/8" (9.5 mm) x 21 mm;  
 ⊕ 3/8" (9.5 mm) x 70 mm; ⊕ 3/8" (9.5 mm); ⊕ 1/4" (6.3 mm) x 3/8" (9.5 mm); ⊕ 1/4" (6.3 mm);  
 4, 4.5, 5, 5.5, 6, 6.5, 7, 8, 9, 10, 11, 12 mm; ⊕ 3/8" (9.5 mm): 13, 14, 17 mm

No.	pcs	☐
58210	20	10

- PL Komplet nasadek z akcesoriami  
 GB Socket set  
 D Sechskantenschlüssel-Einsatz  
 RUS Набор торцевых головок
- CZ Sada nástrčných kľúčů a ráčny  
 RO Trusă chei tubulare cu antrenor  
 H Dugókulcs készlet racsnis hajtókkal  
 E Juego de boquillas con accesorios

24  
PCS



⊕ 1/2" (12.7 mm) x 240 mm; ⊕ 1/2" (12.7 mm): 10, 11, 12, 13, 14, 15, 16, 17, 18, 19, 20, 21, 22, 23,  
 24, 27, 30, 32 mm; ⊕ 1/2" (12.7 mm) x 21 mm; ⊕ 1/2" (12.7 mm) x 250 mm; ⊕ 1/2" (12.7 mm) x 390 mm;  
 ⊕ 1/2" (12.7 mm) x 125 mm; ⊕ 1/2" (12.7 mm) x 250 mm

No.	pcs	☐
58260	24	5

- PL Komplet nasadek z akcesoriami  
 GB Socket set  
 D Sechskantenschlüssel-Einsatz  
 RUS Набор торцевых головок
- CZ Sada nástrčných kľúčů a ráčny  
 RO Trusă chei tubulare cu antrenor  
 H Dugókulcs készlet racsnis hajtókkal  
 E Juego de boquillas con accesorios

52  
PCS

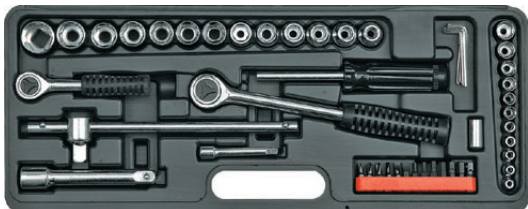

⊕ 1/4" (6.3 mm) x 125 mm; ⊕ 1/2" (12.7 mm) x 250 mm; ⊕ 1/4" (6.3 mm): 4, 4.5, 5, 5.5, 6, 7, 8, 9, 10,  
 11, 13 mm; ⊕ 1/2" (12.7 mm): 8, 9, 10, 11, 12, 13, 14, 15, 16, 17, 18, 19, 20, 21, 22 mm; ⊕ 1/2" (12.7 mm) x 250 mm;  
 ⊕ 1/4" (6.3 mm) x 6 mm; ⊕ 1/4" (6.3 mm) x 70 mm; ⊕ 1/2" (12.7 mm) x 120 mm;  
 ⊕ 6 x 140 mm; ⊕ 3, 4, 5, 6, 7, 8 mm; ⊕ 4, 5, 5.5, 7 mm; ⊕ PH1, PH2, PH3;  
 1.5, 2, 2.5, 3, 3.5, 4 mm

No.	pcs	☐
58530	52	5

- PL Komplet nasadek z akcesoriami  
 GB Socket set  
 D Sechskantenschlüssel-Einsatz  
 RUS Набор торцевых головок
- CZ Sada nástrčných kľúčů a ráčny  
 RO Trusă chei tubulare cu antrenor  
 H Dugókulcs készlet racsnis hajtókkal  
 E Juego de boquillas con accesorios

24  
PCS



⊕ 1/2" (12.7 mm); ⊕ 1/2" (12.7 mm) x 240 mm; ⊕ 1/2" (12.7 mm): 8, 9, 10, 11, 12, 13, 14, 15, 16,  
 17, 18, 19, 20, 21, 22, 23, 24, 27, 30 mm; ⊕ 1/2" (12.7 mm) x 21 mm; ⊕ 1/2" (12.7 mm) x 250 mm;  
 ⊕ 1/2" (12.7 mm) x 125 mm

No.	pcs	☐
58240	24	5

- PL Komplet nasadek z akcesoriami  
 GB Socket set  
 D Sechskantenschlüssel-Einsatz  
 RUS Набор торцевых головок
- CZ Sada nástrčných kľúčů a ráčny  
 RO Trusă chei tubulare cu antrenor  
 H Dugókulcs készlet racsnis hajtókkal  
 E Juego de boquillas con accesorios

52  
PCS

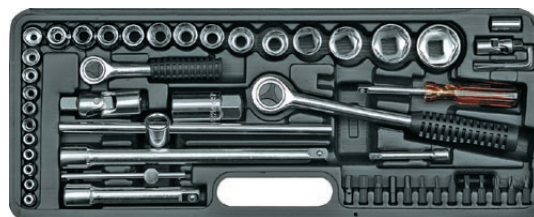

⊕ 1/4" (6.3 mm) x 125 mm; ⊕ 1/2" (12.7 mm) x 250 mm; ⊕ 1/4" (6.3 mm): 4, 4.5, 5, 5.5, 6, 7, 8, 9, 10, 11,  
 13 mm; ⊕ 1/2" (12.7 mm): 10, 11, 12, 13, 14, 15, 16, 17, 18, 19, 22, 27, 30 mm; ⊕ 1/2" (12.7 mm) x 21 mm;  
 ⊕ 1/4" (6.3 mm) x 110 mm; ⊕ 1/2" (12.7 mm) x 250 mm; ⊕ 1/4" (6.3 mm) x 6 mm; ⊕ 1/4" (6.3 mm) x 75 mm;  
 ⊕ 1/2" (12.7 mm) x 125 mm; ⊕ 1/2" (12.7 mm) x 250 mm; ⊕ 1/4" (6.3 mm) x 140 mm;  
 ⊕ 1/4" (6.3 mm); ⊕ 1/2" (12.7 mm); ⊕ 3, 4, 5, 6, 7, 8 mm; ⊕ 4; 5.5; 7 mm; ⊕ PH1; PH2; PH3;  
 1.5; 2; 2.5 mm

No.	pcs	☐
58520	52	5

- PL Komplet nasadek z grzechotką  
 GB Ratchet handle with socket set  
 D Sechskant-Steckschlüssel-Satz  
 RUS Трещотка с насадками
- CZ Sada nástrčných kľúčů a ráčny  
 RO Rotrușă chei tubulare cu antrenor  
 H Dugókulcs készlet racsnis hajtókkal  
 E Mairaca con boquillas

11  
PCS

72T

CrV



No.	mm	L (mm)	size / rozmiar	☐
58600	5; 6; 7; 8; 9; 10; 11; 12; 13; 14	150	1/4" (6.3 mm)	6/24
58602	10; 11; 12; 13; 14; 15; 17; 19; 22; 24	260	1/2" (12.7 mm)	12



- PL Zestaw narzędziowy  
 GB Tool set  
 D Sechskant-Steckschlüssel-Satz  
 RUS Набор торцовых головок
- CZ Sada nástrčných klíčů a ráčny  
 RO Rotrușa chei tubulare cu antrenor  
 H Dugókulcs készlet racsnis hajtókarral  
 E Juego de herramientas

22 PCS 3/8" 10mm

45T AS-DRIVE



3/8" (9.5 mm): 6, 7, 8, 9, 10, 11, 12, 13, 14, 15, 16, 17, 18, 19, 20, 21, 22 mm; 3/8" (9.5 mm); 3/8" (9.5 mm); 3/8" (9.5 mm); 45T



No.	pcs	Icon
58661	22	10

- PL Zestaw narzędziowy  
 GB Tool set  
 D Sechskant-Steckschlüssel-Satz  
 RUS Набор инструментов  
 CZ Sada nástrčných klíčů a ráčny  
 RO Rotrușa chei tubulare cu antrenor  
 H Dugókulcs készlet racsnis hajtókarral  
 E Juego de herramientas

82 PCS 1/2" 12.5mm 1/4" 6.3mm

45T AS-DRIVE



1/2" (12.7 mm): 13, 14, 15, 16, 17, 18, 19, 22, 24, 27, 30, 32 mm; 1/4" (6.3 mm): 4, 4.5, 5, 5.5, 6, 7, 8, 9, 10, 11, 12, 13, 14 mm; 1/2" (12.7 mm) x2; 1/4" (6.3 mm); 1/2" (12.7 mm) (M); 1/4" (6.3 mm); 1/2" (12.7 mm); 1/4" (6.3 mm); 1/2" (12.7 mm); 1/4" (6.3 mm); 1/2" (12.7 mm); 1/4" (6.3 mm); 45T; 1/4" (6.3 mm); 1/2" (12.7 mm) x 5/16" (7.9 mm); 1/4" (6.3 mm) x 1/4" (6.3 mm); 5/16" (7.9 mm): 8, 10, 12 mm; 5/16" (7.9 mm): PH3, PH4; 5/16" (7.9 mm): PZ3, PZ4; 5/16" (7.9 mm): T40, T45, T50, T55; 5/16" (7.9 mm): 8, 10, 12, 14 mm; 1/4" (6.3 mm): 4, 5, 5.7 mm; 1/4" (6.3 mm): PH1, PH2; 1/4" (6.3 mm): PZ1, PZ2; 1/4" (6.3 mm): T8, T10, T15, T20, T25, T30; 1/4" (6.3 mm) 3, 4, 5, 6 mm; 8, 10, 11, 12, 13, 14, 17, 19, 22 mm



No.	pcs	Icon
58686	82	3

- PL Zestaw narzędziowy  
 GB Tool set  
 D Sechskant-Steckschlüssel-Satz  
 RUS Набор инструментов  
 CZ Sada nástrčných klíčů a ráčny  
 RO Rotrușa chei tubulare cu antrenor  
 H Dugókulcs készlet racsnis hajtókarral  
 E Juego de herramientas

72 PCS 1/2" 12.5mm

1/4" 6.3mm CrV 6140

45T AS-DRIVE



1/2" (12.7 mm): 10, 11, 12, 13, 14, 15, 16, 17, 18, 19, 20, 21, 22, 23, 24, 27 mm; 1/4" (6.3 mm): 4, 5, 6, 7, 8, 9, 10, 11, 12, 13 mm; 1/4" (6.3 mm): E4, E5, E6, E7, E8, E10; CrV 6150; 1/2" (12.7 mm): 21 mm; 1/2" (12.7 mm) x 2; 1/4" (6.3 mm); 1/2" (12.7 mm); 1/2" (12.7 mm); 1/4" (6.3 mm); 45T; 1/4" (6.3 mm); 3/8" (9.5 mm) (F) x 1/2" (12.7 mm) (M); 1/4" (6.3 mm) x 1/4" (6.3 mm); 1/4" (6.3 mm): 4, 5, 5.5, 6, 7 mm; CrV 6140; 1/4" (6.3 mm): PH0, PH1, PH2, PH3; CrV 6140; 1/4" (6.3 mm): PZ0, PZ1, PZ2, PZ3; CrV 6140; 1/4" (6.3 mm): T8, T9, T10, T15, T20, T25, T27, T30, T40; CrV 6140; 1/4" (6.3 mm): 3, 4, 5, 6, 7, 8 mm; CrV 6140; 1/4" (6.3 mm): S0, S1, S2, S3; CrV 6140; 1.25, 1.5, 2.5, 3 mm



No.	pcs	Icon
58704	72	4

- PL Zestaw narzędziowy  
 GB Tool set  
 D Sechskant-Steckschlüssel-Satz  
 RUS Набор инструментов  
 CZ Sada nástrčných klíčů a ráčny  
 RO Rotrușa chei tubulare cu antrenor  
 H Dugókulcs készlet racsnis hajtókarral  
 E Juego de herramientas

82 PCS 1/2" 12.5mm 1/4" 6.3mm

45T AS-DRIVE





1/2" (12.7 mm): 14, 15, 16, 17, 18, 19, 20, 22, 24, 27, 30, 32 mm; 1/4" (6.3 mm): 4, 4.5, 5, 5.5, 6, 7, 8, 9, 10, 11, 12, 13, 14 mm; 1/2" (12.7 mm) x2; 1/4" (6.3 mm) x2; 1/4" (6.3 mm); 3/8" (9.5 mm) (F) x 1/2" (12.7 mm) (M); 1/2" (12.7 mm); 1/4" (6.3 mm); 1/2" (12.7 mm): 16, 21 mm; 1/4" (6.3 mm); 1/2" (12.7 mm); 1/4" (6.3 mm); 1/2" (12.7 mm); 1/4" (6.3 mm); 72T; 1/4" (6.3 mm); 1/2" (12.7 mm) x 1/4" (6.3 mm); 1/2" (12.7 mm) x 5/16" (7.9 mm); 5/16" (7.9 mm): PH3, PH4; 5/16" (7.9 mm): PZ3, PZ4; 5/16" (7.9 mm): T40, T45, T50, T55; 5/16" (7.9 mm): 8, 10, 12, 14 mm; 1/4" (6.3 mm): 4, 5, 5.7 mm; 1/4" (6.3 mm): PH1, PH2; 1/4" (6.3 mm): PZ1, PZ2; 1/4" (6.3 mm): T8, T10, T15, T20, T25, T30; 1/4" (6.3 mm): 3, 4, 5, 6 mm; 8, 10, 11, 12, 13, 14, 17, 19, 22 mm



No.	pcs	Icon
58689	82	3

PL Zestaw narzędziowy  
 GB Tool set  
 D Sechskant-Steckschlüssel-Satz  
 RUS Набор инструментов  
 CZ Sada nástrčných klíčů a ráčny  
 RO Rotruasa chei tubulare cu antrenor  
 H Dugókulcs készlet racsnis hajtókarral  
 E Juego de herramientas

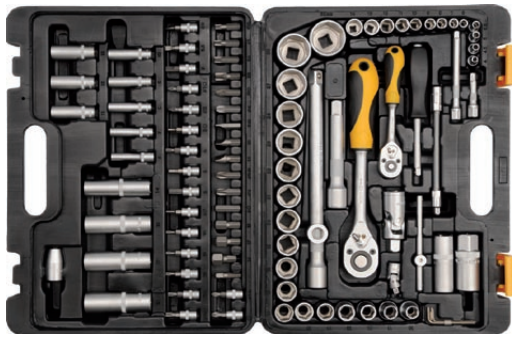
<b>94</b> PCS	<b>1/2"</b> 12.5mm	<b>1/4"</b> 6.3mm	<b>CrV</b> 50BV30	<b>CrV</b> 6150
			<b>72T</b>	<b>AS-DRIVE</b>



1/2" (12.7 mm): 10, 11, 12, 13, 14, 15, 16, 17, 18, 19, 20, 21, 22, 23, 24, 27, 30, 32 mm; 1/4" (6.3 mm): 4, 4.5, 5.5, 6, 7, 8, 9, 10, 11, 12, 13, 14 mm; CrV 50BV30; 1/2" (12.7 mm): 14, 15, 17, 19 mm; 1/4" (6.3 mm): 6, 7, 8, 9, 10, 11, 12, 13 mm; CrV 50BV30; 1/2" (12.7 mm) x2; 1/4" (6.3 mm) x2; 1/4" (6.3 mm); (152 mm); CrV; 1/2" (12.7 mm); 1/4" (6.3 mm); CrV; 1/2" (12.7 mm): 16, 21 mm; CrV; 1/4" (6.3 mm); CrV; 1/2" (12.7 mm); 1/4" (6.3 mm); 72T; CrV; 1/4" (6.3 mm); CrV; 3/8" (9.5 mm) (F) x 1/2" (12.7 mm) (M); CrV; 1/2" (12.7 mm); CrV; 1/4" (6.3 mm) x 1/4" (6.3 mm); CrV; 5/16" (7.9 mm): 8, 10, 12 mm; CrV; 5/16" (7.9 mm): PH3, PH4; CrV; 5/16" (7.9 mm): PZ3, PZ4; CrV; 5/16" (7.9 mm): T40, T45, T50, T55, CrV; 5/16" (7.9 mm): 8, 10, 12, 14 mm; CrV; 1/4" (6.3 mm): 4, 5.5, 7 mm; CrV / CrV 50BV30; 1/4" (6.3 mm): PH1, PH2; CrV / CrV 50BV30; 1/4" (6.3 mm): PZ1, PZ2; CrV / CrV 50BV30; 1/4" (6.3 mm): T8, T10, T15, T20, T25, T30; CrV / CrV 50BV30; 1/4" (6.3 mm): 3, 4, 5, 6 mm; CrV / CrV 50BV30; 1.5, 2, 2.5 mm; CrV 6150



No.	pcs	
<b>58682</b>	94	3

PL Zestaw narzędziowy  
 GB Tool set  
 D Sechskant-Steckschlüssel-Satz  
 RUS Набор инструментов  
 CZ Sada nástrčných klíčů a ráčny  
 RO Rotruasa chei tubulare cu antrenor  
 H Dugókulcs készlet racsnis hajtókarral  
 E Juego de herramientas

<b>94</b> PCS	<b>1/2"</b> 12.5mm	<b>1/4"</b> 6.3mm	<b>CrV</b> 50BV30
			<b>45T</b>
			<b>AS-DRIVE</b>



1/2" (12.7 mm): 10, 11, 12, 13, 14, 15, 16, 17, 18, 19, 20, 21, 22, 23, 24, 27, 30, 32; 1/4" (6.3 mm): 4, 4.5, 5.5, 6, 7, 8, 9, 10, 11, 12, 13, 14 mm; 1/2" (12.7 mm): 14, 15, 17, 19 mm; 1/4" (6.3 mm): 6, 7, 8, 9, 10, 11, 12, 13 mm; 1/2" (12.7 mm) x2; 1/4" (6.3 mm) x2; 3/8" (9.5 mm) (F) x 1/2" (12.7 mm) (M); 1/4" (6.3 mm); 1/2" (12.7 mm); 1/4" (6.3 mm); 1/2" (12.7 mm): 16, 21 mm; 1/4" (6.3 mm); 1/2" (12.7 mm); 1/4" (6.3 mm); 45T; 1/4" (6.3 mm); 1/2" (12.7 mm); x 5/16" (7.9 mm); 1/4" (6.3 mm) x 1/4" (6.3 mm); 5/16" (7.9 mm): 8, 10, 12 mm; 5/16" (7.9 mm): PH3, PH4; 5/16" (7.9 mm): PZ3, PZ4; 5/16" (7.9 mm): T40, T45, T50, T55; 5/16" (7.9 mm): 8, 10, 12, 14 mm; 1/4" (6.3 mm): 4, 5.5, 7 mm; 1/4" (6.3 mm): PZ1, PZ2; 1/4" (6.3 mm): PH1, PH2; 1/4" (6.3 mm): T8, T10, T15, T20, T25, T30; 1/4" (6.3 mm): 3, 4, 5, 6 mm; 1.5, 2, 2.5 mm



No.	pcs	
<b>58687</b>	94	3

PL Zestaw narzędziowy  
 GB Tool set  
 D Sechskant-Steckschlüssel-Satz  
 RUS Набор инструментов  
 CZ Sada nástrčných klíčů a ráčny  
 RO Rotruasa chei tubulare cu antrenor  
 H Dugókulcs készlet racsnis hajtókarral  
 E Juego de herramientas

<b>94</b> PCS	<b>1/2"</b> 12.5mm	<b>1/4"</b> 6.3mm	<b>CrV</b> 50BV30
			<b>45T</b>
			<b>AS-DRIVE</b>

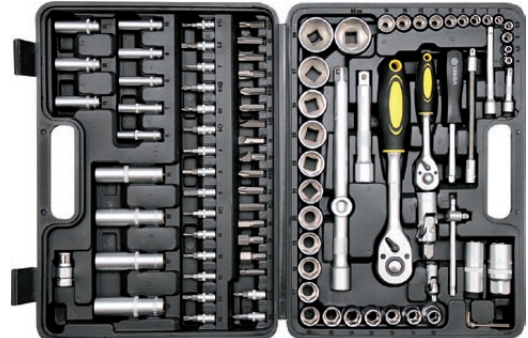

1/2" (12.7 mm): 10, 11, 12, 13, 14, 15, 16, 17, 18, 19, 20, 21, 22, 23, 24, 27, 30, 32 mm; 1/4" (6.3 mm): 4, 4.5, 5.5, 6, 7, 8, 9, 10, 11, 12, 13, 14 mm; 1/2" (12.7 mm): 14, 15, 17, 19 mm; 1/4" (6.3 mm): 6, 7, 8, 9, 10, 11, 12, 13 mm; 1/2" (12.7 mm) x2; 1/4" (6.3 mm) x2; 3/8" (9.5 mm) (F) x 1/2" (12.7 mm) (M); 1/4" (6.3 mm); 1/2" (12.7 mm); 1/4" (6.3 mm); 1/2" (12.7 mm): 16, 21 mm; 1/4" (6.3 mm); 1/2" (12.7 mm); 1/4" (6.3 mm); 45T; 1/4" (6.3 mm); 1/2" (12.7 mm); x 5/16" (7.9 mm); 1/4" (6.3 mm) x 1/4" (6.3 mm); 5/16" (7.9 mm): 8, 10, 12 mm; 5/16" (7.9 mm): PH3, PH4; 5/16" (7.9 mm): PZ3, PZ4; 5/16" (7.9 mm): T40, T45, T50, T55; 5/16" (7.9 mm): 8, 10, 12, 14 mm; 1/4" (6.3 mm): 4, 5.5, 7 mm; 1/4" (6.3 mm): PH1, PH2; 1/4" (6.3 mm): PZ1, PZ2; 1/4" (6.3 mm): T8, T10, T15, T20, T25, T30; 1/4" (6.3 mm): 3, 4, 5, 6 mm; 1.5, 2, 2.5 mm



No.	pcs	
<b>58683</b>	94	3

PL Zestaw narzędziowy  
 GB Tool set  
 D Sechskant-Steckschlüssel-Satz  
 RUS Набор инструментов  
 CZ Sada nástrčných klíčů a ráčny  
 RO Rotruasa chei tubulare cu antrenor  
 H Dugókulcs készlet racsnis hajtókarral  
 E Juego de herramientas

<b>108</b> PCS	<b>1/2"</b> 12.5mm	<b>1/4"</b> 6.3mm	<b>CrV</b> 50BV30
			<b>45T</b>
			<b>AS-DRIVE</b>



1/2" (12.7 mm): 10, 11, 12, 13, 14, 15, 16, 17, 18, 19, 20, 21, 22, 24, 27, 30, 32 mm; 1/4" (6.3 mm): 4, 4.5, 5.5, 6, 7, 8, 9, 10, 11, 12, 13, 14 mm; 1/2" (12.7 mm): 14, 15, 17, 19, 22 mm; 1/4" (6.3 mm): 6, 7, 8, 9, 10, 11, 12, 13 mm; 1/2" (12.7 mm): E10, E11, E12, E14, E16, E18, E20, E24; 1/4" (6.3 mm): E4, E5, E6, E7, E8; CrV 50BV30; 1/2" (12.7 mm) x2; 1/4" (6.3 mm) x2; 3/8" (9.5 mm) (F) x 1/2" (12.7 mm) (M); 1/4" (6.3 mm); 1/2" (12.7 mm); 1/4" (6.3 mm); 1/2" (12.7 mm): 16, 21 mm; 1/4" (6.3 mm); 1/2" (12.7 mm); 1/4" (6.3 mm); 45T; 1/4" (6.3 mm); 1/2" (12.7 mm); (F) x 5/16" (7.9 mm) (F); 5/16" (7.9 mm): 8, 10, 12 mm; 5/16" (7.9 mm): PH3, PH4; 5/16" (7.9 mm): PZ3, PZ4; 5/16" (7.9 mm): T40, T45, T50, T55, T60; 5/16" (7.9 mm): 7, 8, 10, 12, 14 mm; 1/4" (6.3 mm): 4, 5.5, 6.5 mm; 1/4" (6.3 mm): PH1, PH2; 1/4" (6.3 mm): PZ1, PZ2; 1/4" (6.3 mm): T8, T10, T15, T20, T25, T27, T30; 1/4" (6.3 mm): 3, 4, 5, 6; 1.5, 2, 2.5 mm



No.	pcs	
<b>58685</b>	108	3

PL Zestaw narzędziowy  
 GB Tool set  
 D Sechskant-Steckschlüssel-Satz  
 RUS Набор инструментов  
 CZ Sada nástrčných kľúčů a ráčny  
 RO Rotruasa chei tubulare cu antrenor  
 H Dugókulcs készlet racsnis hajtókarral  
 E Juego de herramientas

122 PCS	1/2" 12.5mm	1/4" 6.3mm	CrV 50BV30
CrV 6150	45T	AS-DRIVE	

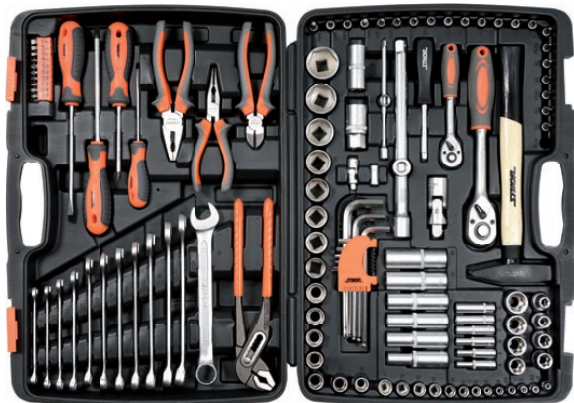

1/2" (12.7 mm): 12, 13, 14, 15, 16, 17, 18, 19, 20, 21, 22, 24, 27, 30, 32 mm; 1/4" (6.3 mm): 4, 4.5, 5, 5.5, 6, 7, 8, 9, 10, 11, 12, 13, 14 mm; 1/2" (12.7 mm): 10, 12, 13, 14, 17, 19 mm; 1/4" (6.3 mm): 4, 5, 6, 7, 8, 9 mm; 1/2" (12.7 mm): E10, E12, E14, E16, E18, E20, E22, E24; CrV 50BV30; 1/2" (12.7 mm); 1/4" (6.3 mm); 3/8" (9.5 mm) (F) x 1/2" (12.7 mm) (M); 3/8" (9.5 mm) (F) x 1/4" (6.3 mm) (M); 1/2" (12.7 mm); 1/4" (6.3 mm); 1/2" (12.7 mm): 16, 21 mm; 1/2" (12.7 mm); 1/4" (6.3 mm); 45T; 1/4" (6.3 mm); 1/4" (6.3 mm) x 1/4" (6.3 mm); 1/4" (6.3 mm); 3, 4, 5, 6 mm; 1/4" (6.3 mm): PH0, PH1, PH2; 1/4" (6.3 mm): PZ0, PZ1, PZ2; 1/4" (6.3 mm): 4.0, 5.5, 6.5 mm; 1/4" (6.3 mm): PH1, PH2, PH3; 1/4" (6.3 mm): PZ2, PZ3; 1/4" (6.3 mm): T8, T10, T15, T20, T25; 1/4" (6.3 mm): T10, T15, T20, T25, T40; 1/4" (6.3 mm): 3, 4, 5, 6 mm; 8, 9, 10, 11, 12, 13, 14, 15, 16, 17, 18, 19 mm; 160 mm; 180 mm; 250 mm; 300 g; 2, 2.5, 3, 4, 5, 6, 7, 8, 10 mm

**STHOR**

No.	pcs	
58690	122	2

PL Zestaw narzędziowy  
 GB Tool set  
 D Sechskant-Steckschlüssel-Satz  
 RUS Набор инструментов  
 CZ Sada nástrčných kľúčů a ráčny  
 RO Rotruasa chei tubulare cu antrenor  
 H Dugókulcs készlet racsnis hajtókarral  
 E Juego de herramientas

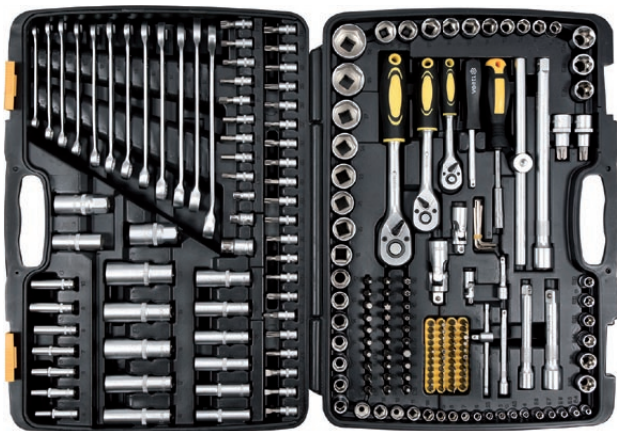

**VOREL**

No.	pcs	
58700	216	1

PL Zestaw narzędziowy  
 GB Tool set  
 D Sechskant-Steckschlüssel-Satz  
 RUS Набор инструментов  
 CZ Sada nástrčných kľúčů a ráčny  
 RO Rotruasa chei tubulare cu antrenor  
 H Dugókulcs készlet racsnis hajtókarral  
 E Juego de herramientas

173 PCS	1/2" 12.5mm	3/8" 10mm	1/4" 6.3mm	CrV 50BV30
CrV 50BV30	45T	AS-DRIVE		



1/2" (12.7 mm): 10, 11, 12, 13, 14, 15, 16, 17, 18, 19, 20, 21, 22, 23, 24, 27, 30, 32 mm; 3/8" (9.5 mm): 10, 11, 12, 13, 14, 15, 16, 17, 18, 19 mm; 1/4" (6.3 mm): 4, 4.5, 5, 5.5, 6, 7, 8, 9, 10, 11, 12, 13, 14 mm; 1/2" (12.7 mm): 16, 17, 18, 19, 22 mm; 3/8" (9.5 mm): 10, 11, 12, 13, 14, 15 mm; 1/4" (6.3 mm): 4, 5, 6, 7, 8, 9, 10 mm; 1/2" (12.7 mm): E18, E20, E24; 3/8" (9.5 mm): E10, E11, E12, E14, E16; 1/4" (6.3 mm): E4, E5, E6, E7, E8; CrV 50BV30; 1/2" (12.7 mm) x2; 3/8" (9.5 mm); 1/4" (6.3 mm) x2; 3/8" (9.5 mm) (F) x 1/2" (12.7 mm) (M); 1/2" (12.7 mm); 3/8" (9.5 mm); 1/4" (6.3 mm); 1/2" (12.7 mm): 16, 21 mm; 3/8" (9.5 mm): 18 mm; 1/4" (6.3 mm); 1/2" (12.7 mm); 3/8" (9.5 mm); 1/4" (6.3 mm); 45T; 1/2" (12.7 mm) x 5/16" (7.9 mm); 3/8" (9.5 mm) x 5/16" (7.9 mm); 1/4" (6.3 mm) x 1/4" (6.3 mm); 5/16" (7.9 mm); 8, 10, 12 mm; 5/16" (7.9 mm): PH3, PH4; 5/16" (7.9 mm): PZ3, PZ4; 5/16" (7.9 mm): T40, T45, T50, T55, T60, T70; 5/16" (7.9 mm): T40, T45, T50, T55, T60, T70; 5/16" (7.9 mm): 7, 8, 10, 12, 14 mm; 1/4" (6.3 mm): T5, T6, T7; 1/4" (6.3 mm): T7, T10, T15, T20, T25, T27, T30, T40, T45; 1/4" (6.3 mm): M5, M6, M8; 1/4" (6.3 mm): RM5, RM6, RM7, RM8, RM9; 1/4" (6.3 mm): 4, 5.5, 6.5, 7 mm; 1/4" (6.3 mm): PH0, PH1, PH2; 1/4" (6.3 mm): PZ0, PZ1, PZ2; 1/4" (6.3 mm): T8, T9, T10, T15, T20, T25, T27, T30; 1/4" (6.3 mm): T8, T9, T10, T15, T20, T25, T27, T30; 1/4" (6.3 mm): 3, 4, 5, 6 mm; 1.25, 1.5, 2, 2.5, 3, 4, 5 mm

**STHOR**

No.	pcs	
58688	173	1

216 PCS	1/2" 12.5mm	3/8" 10mm	1/4" 6.3mm	CrV 50BV30
CrV 6140	45T	AS-DRIVE		

1/2" (12.7 mm): 10, 11, 12, 13, 14, 15, 17, 19, 20, 21, 22, 24, 27, 30, 32 mm; 3/8" (9.5 mm): 10, 11, 12, 13, 14, 15, 16, 17, 18, 19 mm; 1/4" (6.3 mm): 4, 4.5, 5, 5.5, 6, 7, 8, 9, 10, 11, 12, 13, 14 mm; 1/2" (12.7 mm): 16, 17, 18, 19, 22 mm; 3/8" (9.5 mm): 10, 11, 12, 13, 14, 15 mm; 1/4" (6.3 mm): 4, 5, 6, 7, 8, 9, 10 mm; 1/2" (12.7 mm): E20, E22, E24; 3/8" (9.5 mm): E10, E11, E12, E14, E16, E18; 1/4" (6.3 mm): E4, E5, E6, E7, E8; CrV 50BV30; 1/2" (12.7 mm) x2; 3/8" (9.5 mm); 1/4" (6.3 mm) x2; 1/2" (12.7 mm); 3/8" (9.5 mm); 1/4" (6.3 mm); 1/2" (12.7 mm): 16, 21 mm; 3/8" (9.5 mm): 18 mm; 1/2" (12.7 mm); 1/4" (6.3 mm); 1/2" (12.7 mm); 3/8" (9.5 mm); 1/4" (6.3 mm); 45T; 1/4" (6.3 mm); 1/4" (6.3 mm); 1/2" (12.7 mm) x 5/16" (7.9 mm); 3/8" (9.5 mm) x 5/16" (7.9 mm); 1/4" (6.3 mm) x 1/4" (6.3 mm); 5/16" (7.9 mm); 8, 10, 12 mm; 5/16" (7.9 mm): PH3, PH4; 1/4" (6.3 mm): PH1, PH2; CrV 6140; 5/16" (7.9 mm): PZ3, PZ4; 1/4" (6.3 mm): PZ1, PZ2; CrV 6140; 5/16" (7.9 mm): T25, T27, T30, T35, 2xT40, T45, T50; 1/4" (6.3 mm): T8, T10, T15, T20, T25; CrV 6140; 5/16" (7.9 mm): T27, T30, T35, T40, T45, T50; 1/4" (6.3 mm): T8, 2xT10, 2xT15, 2xT20, 2xT25, T40; CrV 6140; 5/16" (7.9 mm): 5.5, 6, 6.5, 7, 8 mm; 1/4" (6.3 mm): 3, 4, 5, 6 mm; CrV 6140; 1/4" (6.3 mm): 3, 4, 5, 6 mm; CrV 6140; 5/16" (7.9 mm): M5, M6, M8, M10; 1/4" (6.3 mm): M5, M6, M8; CrV 6140; 1/4" (6.3 mm): S1, S2; CrV 6140; 1/4" (6.3 mm): 1, 2, 3 mm; CrV 6140; 1/4" (6.3 mm): 6, 8, 10 mm; CrV 6140; 1/4" (6.3 mm): 4, 6, 8 mm; CrV 6140; 1/4" (6.3 mm): 6, 6.5, 8 mm; CrV 6140; 1/4" (6.3 mm): PH3, PH4; CrV 6140; 1/4" (6.3 mm): PZ3, PZ4; CrV 6140; 1/2" (12.7 mm): T55, T60; 1/4" (6.3 mm): T25, T27, T30, T35, 2xT40, T45, T50; CrV 6140; 1/4" (6.3 mm): T27, T30, T35, T40, T45, T50; CrV 6140; 1/4" (6.3 mm): 5.5, 6, 6.5, 7, 8 mm; CrV 6140; 1/4" (6.3 mm): M5, M6, M8, M10; 8, 10, 11, 12, 13, 14, 15, 16, 17, 18, 19, 22 mm; 1.25, 1.5, 2, 2.5, 3, 4, 5 mm



PL Zestaw narzędziowy  
 GB Tool set  
 D Sechskant-Steckschlüssel-Satz  
 RUS Набор инструментов

































CZ Sada nástrčných kľučů a ráčny  
 RO Rotruša chei tubulare cu antrenor  
 H Dugókulcs készlet racsnis hajtókarral  
 E Juego de herramientas

<b>216</b> PCS	<b>1/2"</b> 12.5mm	<b>3/8"</b> 10mm	<b>1/4"</b> 6.3mm
<b>CrV</b> 50BV30	<b>45T</b>	<b>AS-DRIVE</b>	

2



No.	pcs	
58691	216	1

 1/2" (12.7 mm): 10, 11, 12, 13, 14, 15, 17, 19, 20, 21, 22, 24, 27, 30, 32 mm; 3/8" (9.5 mm): 10, 11, 12, 13, 14, 15, 16, 17, 18, 19 mm; 1/4" (6.3 mm): 4, 4.5, 5, 5.5, 6, 7, 8, 9, 10, 11, 12, 13, 14 mm;  1/2" (12.7 mm): 16, 17, 18, 19, 22 mm; 3/8" (9.5 mm): 10, 11, 12, 13, 14, 15 mm; 1/4" (6.3 mm): 4, 5, 6, 7, 8, 9, 10 mm;  1/2" (12.7 mm): E20, E22, E24; 3/8" (9.5 mm): E10, E11, E12, E14, E16, E18; 1/4" (6.3 mm): E4, E5, E6, E7, E8; CrV 50BV30;  1/2" (12.7 mm) x2; 3/8" (9.5 mm) x2;  1/2" (12.7 mm); 3/8" (9.5 mm); 1/4" (6.3 mm);  1/2" (12.7 mm): 16, 21 mm; 3/8" (9.5 mm): 18 mm;  1/2" (12.7 mm); 1/4" (6.3 mm);  3/8" (9.5 mm); 1/4" (6.3 mm); 45T;  1/4" (6.3 mm);  1/4" (6.3 mm);  1/2" (12.7 mm) x 5/16" (7.9 mm); 3/8" (9.5 mm) x 5/16" (7.9 mm); 1/4" (6.3 mm) x 1/4" (6.3 mm);  5/16" (7.9 mm): 6, 6.5, 8 mm; 1/4" (6.3 mm): 4, 5, 6, 5 mm;  5/16" (7.9 mm): PH3, PH4; 1/4" (6.3 mm): PH1, PH2;  5/16" (7.9 mm): PZ3, PZ4; 1/4" (6.3 mm): PZ1, PZ2;  5/16" (7.9 mm): T25, T27, T30, T35, 2xT40, T45, T50; 1/4" (6.3 mm): T8, T10, T15, T20, T25;  5/16" (7.9 mm): T27, T30, T35, T40, T45, T50; 1/4" (6.3 mm): T8, 2xT10, 2xT15, 2xT20, 2xT25, T40;  5/16" (7.9 mm): 5.5, 6, 6.5, 7, 8 mm; 1/4" (6.3 mm): 3, 4, 5, 6 mm;  1/4" (6.3 mm): 3, 4, 5, 6 mm;  5/16" (7.9 mm): M5, M6, M8, M10; 1/4" (6.3 mm): M5, M6, M8;  1/4" (6.3 mm): S1, S2;  1/4" (6.3 mm): 1, 2, 3 mm;  1/4" (6.3 mm): 6, 8, 10 mm;  1/4" (6.3 mm): 4, 6, 8 mm;  1/4" (6.3 mm): 6, 6.5, 8 mm;  1/4" (6.3 mm): PH3, PH4;  1/4" (6.3 mm): PZ3, PZ4;  1/2" (12.7 mm): T55, T60; 1/4" (6.3 mm): T25, T27, T30, T35, 2xT40, T45, T50;  1/4" (6.3 mm): T27, T30, T35, T40, T45, T50;  1/4" (6.3 mm): 5.5, 6, 6.5, 7, 8 mm;  1/4" (6.3 mm): M5, M6, M8, M10;  1/4" (6.3 mm): 8, 10, 11, 12, 13, 14, 15, 16, 17, 18, 19, 22 mm;  1.27, 1.5, 2, 2.5, 3, 4, 5 mm

Memo

**VOREL**

**3**

**Screwdrivers & screwdriver bits**  
**Wkrętaki i końcówki wkrętakowe**



**Screwdrivers, 3 colour handle**  
**Wkrętaki, trójkolorowa rączka**

26-27

**Slotted screwdrivers**

Wkrętaki płaskie..... 26

**Phillips screwdrivers**

Wkrętaki krzyżakowe..... 26

**Pozidrive screwdrivers**

Wkrętaki „Pozidrive”..... 26

**Torx screwdrivers**

Wkrętaki „Torx”..... 26

**Screwdriver sets**

Komplety wkrętaków..... 26

**Ratchet screwdrivers**

Wkrętaki z grzechotką..... 26

**Screwdrivers HI-TEC & sets**  
**Wkrętaki HI-TEC i zestawy**

27-28

**Slotted screwdrivers**

Wkrętaki płaskie..... 27

**Phillips screwdrivers**

Wkrętaki krzyżakowe..... 27

**Torx screwdrivers**

Wkrętaki „Torx”..... 28

**Torx Security screwdrivers**

Wkrętaki „Torx Security”..... 28

**Screwdriver sets**

Komplety wkrętaków..... 28

**Special & impact screwdrivers**  
**Wkrętaki specjalne i udarowe**

29-31

**Two way screwdrivers**

Wkrętaki dwustronne..... 29

**Impact screwdrivers**

Wkrętaki udarowe..... 31

**Telescopic screwdrivers**

Wkrętaki teleskopowe..... 31

**T-bar screwdrivers**

Wkrętaki T-gryf..... 31

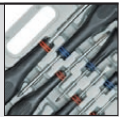
**Screwdriver sets**  
**Zestawy wkrętaków**

31-32

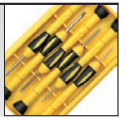
**Precision screwdrivers sets**  
**Zestawy wkrętaków precyzyjnych**

32-33

**Screwdriver bits**  
**Kończówki wkrętakowe**

33-35

**Screwdriver bit sets**

Zestawy końcówek wkrętakowych..... 33

**Screwdriver bit holders**

Uchwyty do końcówek wkrętakowych..... 35

**Nut setter sets**

Zestawy nasadek magnetycznych do wkrętarek..... 35

**Hex & Torx keys & sets**  
**Klucze imbusowe i zestawy**

35-37

**Hex keys**

Klucze imbusowe „Hex”..... 35

**Hex key sets**

Zestawy kluczy imbusowych „Hex”..... 35

**Torx & Torx Tamperproof key sets**Zestawy kluczy imbusowych „Torx”  
i „Torx Tamperproof”..... 37

PL Wkrętak płaski  
GB Slotted screwdriver  
D Schraubendreher schlitz  
RUS Отвёртка шлицевая

CZ Šroubovák  
RO Şurubelniţă  
H Csavarhúzó  
E Destornillador



No.	mm	pcs packing	☐
60912	2x75	12	96/384
60950	3x75	12	96/384
60951	3x100	12	96/384
60952	4x100	12	96/384
60913	4x150	12	96/384
60914	4x200	12	60/240
60915	5x38	12	60/240
60953	5x75	12	60/240
60954	5x100	12	60/240
60955	5x150	12	60/240
60916	5x200	12	36/144
60917	6x38	12	60/240
60956	6x100	12	36/144
60957	6x150	12	36/144
60958	6x200	12	36/144
60959	8x150	6	24/96
60918	8x250	6	24/96

PL Wkrętak  
GB Screwdriver  
D Schraubendreher  
RUS Отвёртка крестовая

CZ Šroubovák  
RO Şurubelniţă  
H Csavarhúzó  
E Destornillador



No.	mm	pcs packing	☐
60931	PZ0x75	12	96/384
60932	PZ0x100	12	96/384
60933	PZ1x75	12	60/240
60934	PZ1x100	12	60/240
60935	PZ1x200	12	36/144
60936	PZ2x100	12	36/144
60937	PZ2x150	12	36/144
60938	PZ2x200	12	36/144
60939	PZ3x150	6	24/96

PL Komplet wkrętaków  
GB Screwdriver set  
D Schraubendreher-Set  
RUS Набор отвёрток

CZ Zámečnické šroubováky  
RO Şurubelniţe de lăcătuşerie  
H Lakatos csavarhúzó  
E Juego de destornilladores

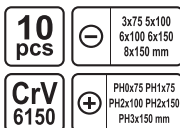

No.	pcs	☐
60970	10	6/24

PL Wkrętak krzyżakowy  
GB Phillips screwdriver  
D Kreuzschlitzschraubendreher  
RUS Отвёртка крестовая

CZ Šroubovák křížový  
RO Şurubelniţă în cruce  
H Csavarhúzó kereszt  
E Destornillador cruz



No.	mm	pcs packing	☐
60920	PH00x65	12	96/384
60961	PH0x75	12	96/384
60962	PH0x100	12	96/384
60921	PH1x38	12	60/240
60963	PH1x75	12	60/240
60964	PH1x100	12	60/240
60965	PH1x150	12	60/240
60922	PH1x250	12	36/144
60923	PH2x38	12	60/240
60966	PH2x100	12	36/144
60967	PH2x150	12	36/144
60968	PH2x200	12	36/144
60924	PH2x250	12	36/144
60969	PH3x150	6	24/96

PL Wkrętak  
GB Screwdriver  
D Schraubendreher  
RUS Отвёртка

CZ Šroubovák  
RO Şurubelniţă  
H Csavarhúzó  
E Destornillador



No.	mm	pcs packing	☐
60880	T5x75	12	96/384
60881	T6x75	12	96/384
60882	T7x75	12	96/384
60883	T8x75	12	96/384
60884	T9x75	12	96/384
60885	T10x100	12	60/240
60886	T15x100	12	60/240
60887	T20x100	12	60/240
60888	T25x100	12	36/144
60889	T27x100	12	36/144
60890	T30x100	12	36/144
60891	T40x100	6	24/96

PL Zestaw wkrętak z grzechotką  
GB Ratchet screwdriver set  
D Ratschenschraubendreher-set mit einsetzbar  
RUS Отвёртка реверсивная с набором бит и торцевых головок

CZ Ráčnový kloubový šroubovák  
RO Set şurubelniţe  
H Dugókulcs és bit készlet csukló  
E Juego con destornillador y carraca

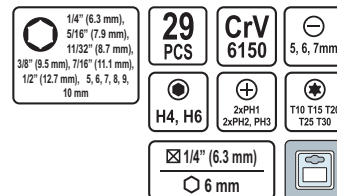

No.	pcs	☐
60975	29	6/24

- PL Zestaw wkrętek z grzechotką  
 GB Ratchet screwdriver set  
 D Ratschenschraubendreher-set mit einsätzen  
 RUS Отвёртка реверсивная с набором бит и торцевых головок  
 CZ Ráčnový kloubový šroubovák  
 RO Set surubelnita  
 H Dugókulcs és bit készlet csukló  
 E Juego con destornillador y carraca

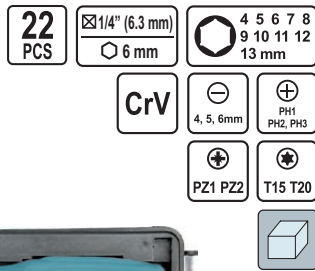

**VOREL**

No.	pcs	cube
60976	22	12/24

- PL Wkrętki płaski  
 GB Slotted screwdriver  
 D Schraubendreher schlitz  
 RUS Отвёртка шлицевая  
 CZ Šroubovák  
 RO Şurubelniţă  
 H Csavarhúzó  
 E Destornillador



**VOREL**

No.	mm	cube
61090	6.0x38	12/192

- PL Wkrętki krzyżakowy  
 GB Phillips screwdriver  
 D Kreuzschlitzschraubendreher  
 RUS Отвёртка крестовая  
 CZ Šroubovák křížový  
 RO Şurubelniţă în cruce  
 H Csavarhúzó kereszt  
 E Destornillador cruz



**VOREL**

No.	mm	cube
61290	PH2x38	12/288

- PL Wkrętki krzyżakowy  
 GB Phillips screwdriver  
 D Kreuzschlitzschraubendreher  
 RUS Отвёртка крестовая  
 CZ Šroubovák křížový  
 RO Şurubelniţă în cruce  
 H Csavarhúzó kereszt  
 E Destornillador cruz



**VOREL**

No.	mm	cube
61210	PH0x63	12/240
61220	PH0x75	12/240
61230	PH0x100	12/240
61240	PH0x150	12/240

- PL Wkrętki płaski  
 GB Slotted screwdriver  
 D Schraubendreher schlitz  
 RUS Отвёртка  
 CZ Šroubovák  
 RO Şurubelniţă  
 H Csavarhúzó  
 E Destornillador



**VOREL**

No.	mm	cube
61010	2.5x63	12/240
61020	3.2x75	12/240
61030	3.2x100	12/240
61040	3.2x150	12/240
61050	5.0x75	12/240
61060	5.0x100	12/240
61070	5.0x150	12/240
61080	5.0x200	12/240

- PL Wkrętki płaski  
 GB Slotted screwdriver  
 D Schraubendreher schlitz  
 RUS Отвёртка шлицевая  
 CZ Šroubovák  
 RO Şurubelniţă  
 H Csavarhúzó  
 E Destornillador



**VOREL**

No.	mm	cube
61100	6.0x100	12/144
61110	6.0x100	HEX 12/144
61120	6.0x150	12/144
61130	6.0x150	HEX 12/144
61140	6.0x200	12/144
61150	6.0x250	12/144
61160	8.0x150	6/72
61170	8.0x150	HEX 6/72

- PL Wkrętki krzyżakowy  
 GB Phillips screwdriver  
 D Kreuzschlitzschraubendreher  
 RUS Отвёртка крестовая  
 CZ Šroubovák křížový  
 RO Şurubelniţă în cruce  
 H Csavarhúzó kereszt  
 E Destornillador cruz



**VOREL**

No.	mm	cube
61250	PH1x75	12/240
61260	PH1x100	12/240
61270	PH1x150	12/240
61280	PH1x200	12/240

PL Wkrętak krzyżakowy  
GB Phillips screwdriver  
D Kreuzschlitzschraubendreher  
RUS Отвёртка крестовая

CZ Šroubovák křížový  
RO Şurubelniţă în cruce  
H Csavarhúzó kereszt  
E Destornillador cruz



**VOREL**

No.	mm		
61300	PH2x100		12/144
61310	PH2x100	HEX	12/144
61320	PH2x150		12/144
61330	PH2x150	HEX	12/144
61340	PH2x200		12/144
61350	PH2x250		12/144

PL Wkrętak  
GB Screwdriver  
D Schraubendreher  
RUS Отвёртка

CZ Šroubovák  
RO Şurubelniţă  
H Csavarhúzó  
E Destornillador



**VOREL**

No.	mm		
61375	T5x75		12/240
61376	T6x75		12/240
61377	T7x75		12/240
61378	T8x75		12/240
61379	T9x75		12/240

PL Wkrętak  
GB Screwdriver  
D Schraubendreher  
RUS Отвёртка

CZ Šroubovák  
RO Şurubelniţă  
H Csavarhúzó  
E Destornillador



**VOREL**

No.	mm		
61392	T10x200		12/240
61393	T15x200		12/240
61394	T20x200		12/240
61395	T25x200		12/144

PL Komplet wkrętaków  
GB Screwdriver set  
D Schraubendrehersatz  
RUS Набор отвёрток

CZ Zámečnické šroubováky  
RO Şurubelniţe de lăcătuşerie  
H Lakatos csavarhúzó  
E Juego de destornilladores



**VOREL**

No.	pcs		
61590	8		5/20

PL Wkrętak krzyżakowy  
GB Phillips screwdriver  
D Kreuzschlitzschraubendreher  
RUS Отвёртка крестовая

CZ Šroubovák křížový  
RO Şurubelniţă în cruce  
H Csavarhúzó kereszt  
E Destornillador cruz



**VOREL**

No.	mm		
61360	03x150		6/72
61370	03x150	HEX	6/72

PL Wkrętak  
GB Screwdriver  
D Schraubendreher  
RUS Отвёртка

CZ Šroubovák  
RO Şurubelniţă  
H Csavarhúzó  
E Destornillador



**VOREL**

No.	mm		
61380	T10x100		12/240
61381	T15x100		12/240
61382	T20x100		12/240
61383	T25x100		12/144
61384	T27x100		12/144
61385	T30x100		12/144
61386	T40x100		12/144

PL Komplet wkrętaków  
GB Screwdriver set  
D Schraubendrehersatz  
RUS Набор отвёрток  
CZ Zámečnické šroubováky  
RO Şurubelniţe de lăcătuşerie  
H Lakatos csavarhúzó  
E Juego de destornilladores



**VOREL**

No.	pcs	packing:	
61550	5		5/20
61560	6		6/24
61580	8		6/12

PL Komplet wkrętaków  
GB Screwdriver set  
D Schraubendrehersatz  
RUS Набор отвёрток

CZ Zámečnické šroubováky  
RO Şurubelniţe de lăcătuşerie  
H Lakatos csavarhúzó  
E Juego de destornilladores



**VOREL**

No.	pcs		
61600	10		6/12

PL Wkrętak  
GB Screwdriver  
D Schraubendreher  
RUS Отвёртка с 2-мя двусторонними вставками

CZ Šroubovák  
RO Şurubelniţă  
H Csavarhúzó  
E Destornillador



No.	pcs	box
61640	2	8/96

PL Wkrętak płasko-krzyżakowy  
GB Slotted - phillips screwdriver  
D Umsteckschraubendreher  
RUS Отвёртка двухсторонняя

CZ Ploché a křížový šroubovák  
RO Şurubelniţă dublu cap: plata + cruce  
H Csavarhúzó, lapos-kereszt  
E Destornillador plano-cruz



No.	type	box
60930	R-3	25/100

PL Wkrętak dwustronny  
GB Two-way screwdriver  
D Schraubendreher mit doppelschlit  
RUS Отвёртка двухсторонняя со сменными вставками

CZ Dvoustranný šroubovák  
RO Şurubelniţă dublu capăt  
H Kétoldalas csavarhúzó  
E Destornillador de dos caras

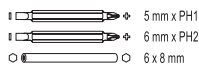

No.	pcs	box
64654	4	12/72

PL Wkrętak  
GB Screwdriver  
D Schraubendreher  
RUS Отвёртка магнитная с битами

CZ Šroubovák  
RO Şurubelniţă  
H Csavarhúzó  
E Destornillador



No.	bits	box
65040	5	25/100

PL Wkrętak płasko-krzyżakowy  
GB Slotted - phillips screwdriver  
D Umsteckschraubendreher  
RUS Отвёртка двухсторонняя

CZ Ploché a křížový šroubovák  
RO Şurubelniţă dublu cap: plata + cruce  
H Csavarhúzó, lapos-kereszt  
E Destornillador plano-cruz

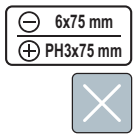

No.	type	box
60910	R-1	30

PL Wkrętak dwustronny  
GB Two-way screwdriver  
D Umsteckschraubendreher  
RUS Отвёртка двухсторонняя

CZ Dvoustranný šroubovák  
RO Şurubelniţă dublu capăt  
H Kétoldalas csavarhúzó  
E Destornillador de dos caras



No.	box
64950	25/100

PL Komplet wkrętek  
GB Screwdriver set  
D Schraubendrehersatz  
RUS Набор отвёрток

CZ Zámečnické šroubováky  
RO Şurubelniţe de lăcătuşerie  
H Lakatos csavarhúzó  
E Juego de destornilladores

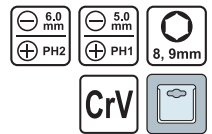

No.	box
64951	12/72

PL Wkrętak  
GB Screwdriver  
D Schraubendreher  
RUS Отвёртка магнитная с битами

CZ Šroubovák  
RO Şurubelniţă  
H Csavarhúzó  
E Destornillador

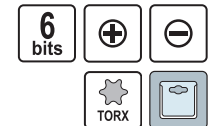

No.	bits	box
65041	6	25/100

- PL Wkrętak wyginany  
 GB Screwdriver  
 D Schraubendreher  
 RUS Отвёртка с набором бит-гибкая
- CZ Ohybaný šroubovák  
 RO Şurubelniţă flexibilă + bituri  
 H Hajlítóttszárú csavarbehajtó  
 E Destornillador con extensión flexible



No.	bits	
65080	7	12/48

- PL Zestaw wkrętek z grzechotką i bitami  
 GB Ratchet screwdriver set with bits  
 D Schraubendreher mit ratche  
 RUS Отвёртка реверсивная с набором бит  
 CZ Šroubovák z řehťačkou  
 RO Şurubelniţă cu clichet  
 H Racsnis csavarbehajtó  
 E Juego con destornillador y carraca

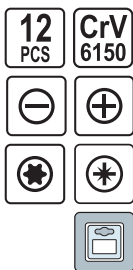

- 1/4" (6,3 mm): 3, 3.5, 4, 5, 5.5 mm (L=25 mm)  
 1/4" (6,3 mm): PH0, PH1, PH2 (L=25 mm)  
 1/4" (6,3 mm): T20, T25 (L=25 mm)  
 1/4" (6,3 mm): P20, P21, P22 (L=25 mm)



No.	pcs	
64658	12	12/72

- PL Wkrętak z grzechotką i wymiennymi końcówkami  
 GB Ratchet screwdriver set with bits  
 D Schraubendreher mit ratche  
 RUS Отвёртка реверсивная с набором бит  
 CZ Šroubovák z řehťačkou  
 RO Şurubelniţă cu clichet  
 H Racsnis csavarbehajtó  
 E Juego con destornillador y carraca

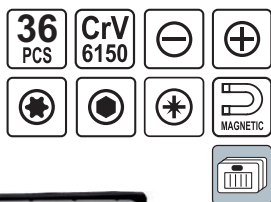

- 1/4" (6,3 mm): 3, 3.5, 4, 5, 5.5 mm (L=25 mm)  
 1/4" (6,3 mm): PH0, PH1, PH2, PH3 (L=25 mm)  
 1/4" (6,3 mm): T10, T15, T20, T25, T27, T30 (L=25 mm)  
 1/4" (6,3 mm): P20, P21, P22, P23 (L=25 mm)  
 1/4" (6,3 mm): 3, 4 mm (L=25 mm)  
 1/4" (6,3 mm): 4, 4.5, 5, 6, 7, 8, 9, 10, 11, 12, 13 mm  
 50 mm



No.	pcs	
64660	36	6/24

- PL Zestaw wkrętek z grzechotką  
 GB Ratchet screwdriver set  
 D Ratschenschraubendreher-set mit einsätzen  
 RUS Набор инструментов, отвёртка + головки + насадки  
 CZ Ráčnový kloubový šroubovák  
 RO Set surubelniţa  
 H Dugkulcs és bit készlet csukló  
 E Juego con destornillador y carraca



No.	pcs	
65170	41	15/30

- PL Wkrętak z grzechotką i wymiennymi końcówkami  
 GB Ratchet screwdriver set with bits  
 D Schraubendreher mit ratche  
 RUS Отвёртки с набором бит  
 CZ Šroubovák z řehťačkou  
 RO Şurubelniţă cu clichet  
 H Racsnis csavarbehajtó  
 E Juego con destornillador y carraca

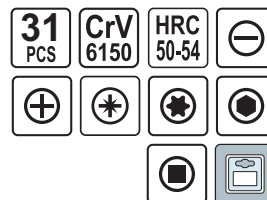

- 1/4" (6,3 mm): 3, 3.5, 4, 5, 5.5, 6 mm (L=25 mm)  
 1/4" (6,3 mm): PH0, PH1, PH2, PH3 (L=25 mm)  
 1/4" (6,3 mm): T10, T15, T20, T25, T27, T30 (L=25 mm)  
 1/4" (6,3 mm): P20, P21, P22, P23 (L=25 mm)  
 1/4" (6,3 mm): 2, 2.5, 3, 4, 5, 6 mm (L=25 mm)  
 1/4" (6,3 mm): S0, S1 (L=25 mm)  
 2,0 x 50 mm  
 PH00 x 50 mm



No.	pcs	
64655	31	6/36

- PL Wkrętak z grzechotką i wymiennymi końcówkami  
 GB Ratchet screwdriver set with bits  
 D Schraubendreher mit ratche  
 RUS Отвёртка реверсивная с набором бит  
 CZ Šroubovák z řehťačkou  
 RO Şurubelniţă cu clichet  
 H Racsnis csavarbehajtó  
 E Juego con destornillador y carraca

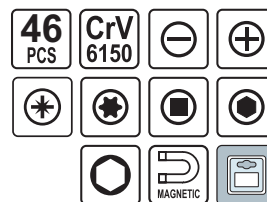

- 1/4" (6,3 mm): 2, 3, 3.5, 4, 4.5, 5.5, 6.5, 7 mm (L=30 mm)  
 1/4" (6,3 mm): PH0, PH1, PH2, PH3 (L=30 mm)  
 1/4" (6,3 mm): T10, T15, T20, T25, T27, T30 (L=30 mm)  
 1/4" (6,3 mm): P20, P21, P22, P23 (L=30 mm)  
 1/4" (6,3 mm): 2, 2.5, 3, 4, 5, 6 (L=30 mm)  
 1/4" (6,3 mm): S0, S1, S2, S3 (L=30 mm)  
 1/4" (6,3 mm): 4, 5, 5.5, 6, 7, 8, 9, 10, 11, 12, 13 mm  
 1/4" (6,3 mm)



No.	pcs	
64657	46	6/24



PL Wkrętkak udarowy  
GB Impact screwdriver  
D Schlagschrauber  
RUS Отвёртка цельнометаллическая ударная

CZ Narazový šroubovák kovový  
RO Şurubelniţă metalică cu percutor  
H Csavarbehajtó, ütő üzemmóddal  
E Destornillador de percusión



No.	bits	box
65120	4	25

PL Wkrętkak magnetyczny, teleskopowy  
GB Telescopic screwdriver, magnetic  
D Schraubendreher  
RUS Отвёртка магнитная с битами

CZ Magnetický řoubavak -teleskop  
RO Surubelniţa telescopică cu magnet  
H Mágneses csavarbehajtó-teleszkop  
E Destornillador magnético-telescop

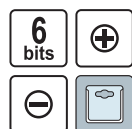

No.	bits	box
65045	6	25/100

PL Wkrętkak T-gryf  
GB T-bar screwdriver  
D T-griff schraubendrehersatz  
RUS Отвёртка с Т-образной ручкой и насадками

CZ Šroubovák T-gryf  
RO Set surubelniţe tip „T”  
H Csavarbehajtó, T-gryf  
E Destornillador T-grifo



No.	bits	box
65100	20	10/80

PL Komplet wkrętek  
GB Screwdriver set  
D Schraubendrehersatz  
RUS Набор отвёрток слесарных

CZ Zámečnické šroubováky  
RO Şurubelniţe de lăcătuşerie  
H Lakatos csavarhúzó  
E Juego de destornilladores



No.	pcs	box
64060	6	20/60

PL Wkrętkak udarowy  
GB Impact screwdriver  
D Schlagschrauber  
RUS Отвёртка цельнометаллическая ударная

CZ Narazový šroubovák kovový  
RO Şurubelniţă metalică cu percutor  
H Csavarbehajtó, ütő üzemmóddal  
E Destornillador de percusión



No.	bits	box
65122	6	20

PL Wkrętkak z teleskopowym chwytakiem magnetycznym  
GB Screwdriver with magnetic telescopic pick-up tool  
D Schraubendreher mit auschiebbaren magnetischem halter  
RUS Отвёртка магнитная с битами

CZ Magnetický řoubavak -teleskop  
RO Şurubelniţa cu magnet-telescop  
H Mágneses csavarbehajtó-teleszkop  
E Destornillador magnético-telescop

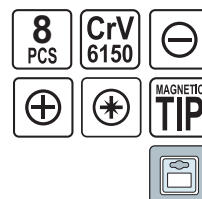

No.	pcs	box
64650	8	12/72

PL Wkrętkak T-gryf  
GB T-bar screwdriver set  
D T-griff schraubendrehersatz  
RUS Отвёртка с Т-образной ручкой и насадками  
CZ Šroubovák T-gryf  
RO Set surubelniţe tip „T”  
H Csavarbehajtó, T-gryf  
E Destornillador T-grifo

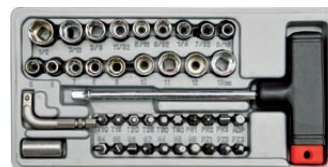
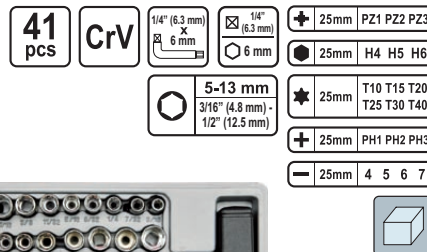

No.	pcs	box
65150	41	24

PL Komplet wkrętek  
GB Screwdriver set  
D Schraubendrehersatz  
RUS Набор отвёрток слесарных

CZ Zámečnické šroubováky  
RO Şurubelniţe de lăcătuşerie  
H Lakatos csavarhúzó  
E Juego de destornilladores

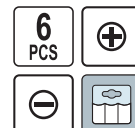

No.	pcs	box
64050	6	20/80

PL Komplet wkrętek  
GB Screwdriver set  
D Schraubendrehersatz  
RUS Набор отвёрток

CZ Zámečnické šroubováky  
RO Şurubelnițe de lăcătușerie  
H Lakatos csavarhúzó  
E Juego de destornilladores



No.	pcs	box
64070	7	20/80

PL Zestaw końcówek śrubokrętowych + uchwyt  
GB Precision screwdriver bits + bit holder  
D Schraubendreherbitsatz + Bithalter  
RUS Отвёртка с набором специальных бит  
CZ Sada bitův + držák  
RO Truse bit + capete şurubel niță  
H Bitkészlet + szár  
E Juego de llaves especiales + mandril

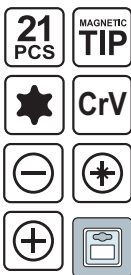

No.	pcs	box
64370	21	12/60

PL Zestaw wkrętek precyzyjnych  
GB Precision screwdriver set  
D Präzisions-feinmechanikersatz  
RUS Набор отвёрток для точных работ

CZ Šroubováky sada  
RO Set şurubelnițe  
H Órás csavarhúzó készlet  
E Destornilladores precisos

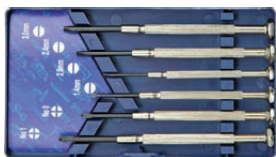
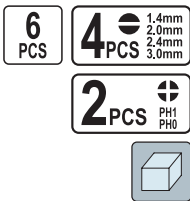

No.	pcs	box
64310	6	20/100

PL Zestaw końcówek śrubokrętowych + uchwyt  
GB Precision screwdriver bits + bit holder  
D Schraubendreherbitsatz + Bithalter  
RUS Отвёртка с набором специальных бит  
CZ Sada bitův + držák  
RO Truse bit + capete şurubel niță  
H Bitkészlet + szár  
E Juego de llaves especiales + mandril

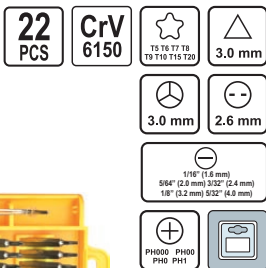

No.	pcs	box
64395	22	10/50

PL Komplet wkrętek  
GB Screwdriver set  
D Schraubendrehersatz  
RUS Набор отвёрток

CZ Zámečnické šroubováky  
RO Şurubelnițe de lăcătușerie  
H Lakatos csavarhúzó  
E Juego de destornilladores

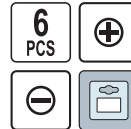

No.	pcs	box
64090	6	10/60

PL Zestaw końcówek śrubokrętowych + uchwyt  
GB Precision screwdriver bits + bit holder  
D Schraubendreherbitsatz + Bithalter  
RUS Отвёртка с набором специальных бит  
CZ Sada bitův + držák  
RO Truse bit + capete şurubel niță  
H Bitkészlet + szár  
E Juego de llaves especiales + mandril

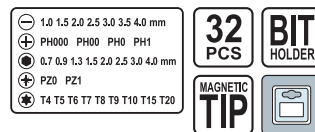

No.	pcs	box
64371	32	10/20

PL Zestaw wkrętek precyzyjnych  
GB Precision screwdriver set  
D Präzisions-feinmechanikersatz  
RUS Набор отвёрток для точных работ  
CZ Šroubováky sada  
RO Set şurubelnițe  
H Órás csavarhúzó készlet  
E Destornilladores precisos



No.	pcs	box
64330	11	25/100

PL Zestaw końcówek śrubokrętowych + uchwyt  
GB Precision screwdriver bits + bit holder  
D Schraubendreherbitsatz + Bithalter  
RUS Отвёртка с набором специальных бит  
CZ Sada bitův + držák  
RO Truse bit + capete şurubel niță  
H Bitkészlet + szár  
E Juego de llaves especiales + mandril

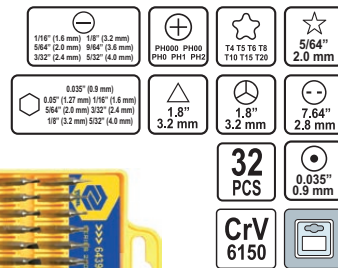

No.	pcs	box
64396	32	10/50

- PL Wkrętki precyzyjne
- GB Precision screwdriver set
- D Präzisions-Schraubendrehersatz
- RUS Набор отвёрток для точных работ
- CZ Precizní šroubováky
- RO Șurubelnițe precise
- H Precíziós csavarhúzó
- E Destornilladores precisos

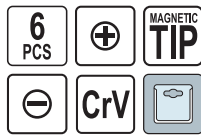

No.		pcs	☐
64553	PH00; PH0; PH1; 1.4; 2.4; 3.0	6	10/60
64554	T5; T6; T7; T8; T9; T10	6	10/60

- PL Zestaw końcówek śrubokrętowych
- GB Screwdriver bit set
- D Schraubendreherbitsatz
- RUS Набор бит крестовых
- CZ Sada bitů
- RO Truse bit
- H Bitkészlet
- E Puntas de destornilladora



No.	mm	pcs packing	☐
65520	PZ2x25	10	25/200

- PL Końcówki śrubokrętowe do gipsów
- GB Screwdriver bit set
- D Phillips-Bits mit Schutz PH2
- RUS Насадки для быстрого заворачивания саморезов по гипскартону
- CZ Koncovky šroubovákové na sádru
- RO Capete pt. ghips pt. șurubelniță
- H Csavarhúzóvégek gipszhez
- E Puntas con limitador ph2 escayola



No.	pcs packing	☐
65800	2	12/144

- PL Zestaw końcówek śrubokrętowych
- GB Screwdriver bit set
- D Schraubendreherbitsatz
- RUS Набор бит с шлицами
- CZ Sada bitů
- RO Truse bit
- H Bitkészlet
- E Juego de llaves especiales

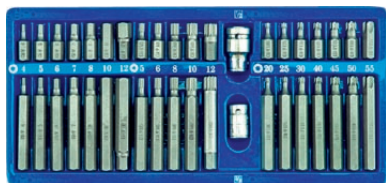
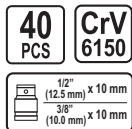

- ☉ 30 mm: T20; T25; T30; T40; T45; T50; T55, 75 mm: T20; T25; T30; T40; T45; T50; T55, ☉ 30 mm: H4; H5; H6; H7; H8; H10; H12, 75 mm: H4; H5; H6; H7; H8; H10; H12, ☉ 30 mm: M5; M6; M8; M10; M12, 75 mm: M5; M6; M8; M10; M12

No.	pcs	☐
66400	40	10

- PL Zestaw końcówek śrubokrętowych
- GB Screwdriver bit set
- D Schraubendreherbitsatz
- RUS Биты двухсторонние
- CZ Sada bitů
- RO Truse bit
- H Bitkészlet
- E Puntas de destornilladora

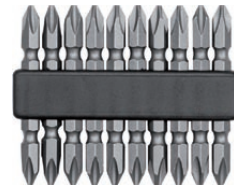

No.	pcs	☐
65700	10	25/100

- PL Zestaw końcówek śrubokrętowych
- GB Screwdriver bit set
- D Schraubendreherbitsatz
- RUS Набор бит крестовых
- CZ Sada bitů
- RO Truse bit
- H Bitkészlet
- E Puntas de destornilladora

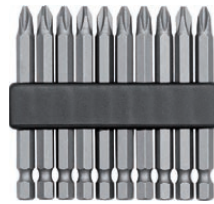

No.	mm	pcs packing	☐
65610	PH1x25	10	25/200
65620	PH1x50	10	25/100
65630	PH2x25	10	25/200
65640	PH2x50	10	25/100
65650	PH2x75	10	25/100

- PL Zestaw końcówek śrubokrętowych
- GB Screwdriver bit set
- D Schraubendreherbitsatz
- RUS Набор битов
- CZ Sada bitů
- RO Truse bit
- H Bitkészlet
- E Puntas de destornilladora

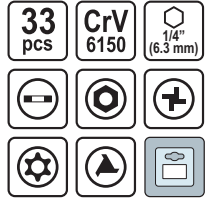

No.	pcs	☐
66330	33	12/60

- PL Zestaw końcówek śrubokrętowych
- GB Screwdriver bit set
- D Schraubendreherbitsatz
- RUS Набор бит с шлицами
- CZ Sada bitů
- RO Truse bit
- H Bitkészlet
- E Juego de llaves especiales



- ☉ 30 mm: T20; T25; T30; T40; T45; T50; T55, 75 mm: T20; T25; T30; T40; T45; T50; T55, ☉ 30 mm: H4; H5; H6; H7; H8; H10; H12, 75 mm: H4; H5; H6; H7; H8; H10; H12, ☉ 30 mm: M5; M6; M8; M10; M12, 75 mm: M5; M6; M8; M10; M12

No.	pcs	☐
66410	40	10

PL Zestaw końcówek śrubokrętowych  
 GB Screwdriver bit set  
 D Schraubendreherbitsatz  
 RUS Набор специальных бит

CZ Sada bitů  
 RO Truse bit  
 H Bitkészlet  
 E Juego de llaves especiales

7 PCS

T25 T30 T40 T45 T50 T55

30mm

10mm

CrV 6150

1/2" (12.5 mm) x 10 mm



No.	pcs	Icon
66570	7	24/72

PL Zestaw końcówek śrubokrętowych  
 GB Screwdriver bit set  
 D Schraubendreherbitsatz  
 RUS Набор специальных бит

CZ Sada bitů  
 RO Truse bit  
 H Bitkészlet  
 E Juego de llaves especiales

7 PCS

H4 H5 H6 H8 H10 H12

30mm

1/2" (12.5 mm) x 10 mm

10mm

CrV 6150



No.	pcs	Icon
66710	7	24/72

PL Zestaw końcówek śrubokrętowych  
 GB Screwdriver bit set  
 D Schraubendreherbitsatz  
 RUS Набор специальных бит

CZ Sada bitů  
 RO Truse bit  
 H Bitkészlet  
 E Juego de llaves especiales

6 PCS

M5, M6, M8, M10, M12

30mm

1/2" (12.5 mm) x 10 mm

10mm

CrV 6150



No.	pcs	Icon
66760	6	24/72

PL Zestaw końcówek śrubokrętowych  
 GB Screwdriver bit set  
 D Schraubendreherbitsatz  
 RUS Набор бит с магнитным адаптером

CZ Sada bitů  
 RO Truse bit  
 H Bitkészlet  
 E Juego de llaves especiales

+

-



No.	pcs	Icon
66080	7	20/200

PL Zestaw końcówek śrubokrętowych  
 GB Screwdriver bit set  
 D Schraubendreherbitsatz  
 RUS Набор специальных бит

CZ Sada bitů  
 RO Truse bit  
 H Bitkészlet  
 E Juego de llaves especiales

15 PCS

TORX

CrV 6150

1/2" (12.5 mm) x 10 mm



30 mm: T20; T25; T30; T40; T45; T50; T55, 75 mm: T20; T25; T30; T40; T45; T50; T55

No.	pcs	Icon
66580	15	20

PL Zestaw końcówek śrubokrętowych  
 GB Screwdriver bit set  
 D Schraubendreherbitsatz  
 RUS Набор специальных бит

CZ Sada bitů  
 RO Truse bit  
 H Bitkészlet  
 E Juego de llaves especiales

15 PCS

HEX

1/2" (12.5 mm) x 10 mm

CrV 6150



30 mm: H4; H5; H6; H7; H8; H10; H12, 75 mm: H4; H5; H6; H7; H8; H10; H12

No.	pcs	Icon
66720	15	20

PL Zestaw końcówek śrubokrętowych  
 GB Screwdriver bit set  
 D Schraubendreherbitsatz  
 RUS Набор специальных бит

CZ Sada bitů  
 RO Truse bit  
 H Bitkészlet  
 E Juego de llaves especiales

11 PCS

SPLINE

1/2" (12.5 mm) x 10 mm

CrV 6150



30 mm: M5; M6; M8; M10; M12, 75 mm: M5; M6; M8; M10; M12

No.	pcs	Icon
66770	11	20

PL Zestaw końcówek śrubokrętowych  
 GB Screwdriver bit set  
 D Schraubendreherbitsatz  
 RUS Набор двусторонних бит в держателе

CZ Sada bitů  
 RO Truse bit  
 H Bitkészlet  
 E Juego de llaves especiales

10 PCS

+

-



No.	pcs	Icon
66112	10	25/100

- PL Zestaw końcówek śrubokrętowych  
 GB Screwdriver bit set  
 D Schraubendreherbitsatz  
 RUS Набор бит с магнитным адаптером  
 CZ Sada bitů  
 RO Truse bit  
 H Bitkészlet  
 E Juego de llaves especiales

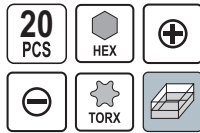

No.	pcs	☐
66210	20	12/48

- PL Uchwyt do końcówek śrubokrętowych  
 GB Screwdriver bit holder  
 D Bithalter  
 RUS Адаптер для бит магнитный
- CZ Držák na šroubovkové koncovky  
 RO Capete șurubelniță  
 H Szár a csavarhűzővégekhez  
 E Mandril para puntas



No.	☐
65850	30/300

- PL Klucz sześciokątny  
 GB Hex key  
 D Sechskant-Stiftschlüssel  
 RUS Шестигранный
- CZ Imbusový klíč  
 RO Cheie imbus  
 H Imbisz kulcs  
 E Llave hexagonal



No.	mm	☐
56040	4	1000/2000
56050	5	400/800
56060	6	400/800
56070	7	300/600
56080	8	200/400
56100	10	100/200
56120	12	50/100
56130	13	50/100
56140	14	50/100
56170	17	25/50

- PL Zestaw końcówek śrubokrętowych  
 GB Screwdriver bit set  
 D Schraubendreherbitsatz  
 RUS Набор бит с магнитным адаптером
- CZ Sada bitů  
 RO Truse bit  
 H Bitkészlet  
 E Juego de llaves especiales



No.	pcs	☐
66200	20	12/48

- PL Komplet końcówek nasadowych  
 GB Screwdriver bit set  
 D Bit-Steckschlüsselsatz  
 RUS Набор торцевых головок
- CZ Sada nastrčných koncovok  
 RO Set de capete tubulare  
 H Csőkulcskészlet  
 E Juego de puntas de calar

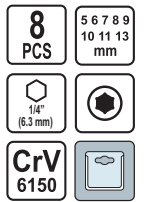

No.	pcs	☐
66113	8	25/50

- PL Zestaw kluczy imbusowych  
 GB Hex key set  
 D Sechskant-Stiftschlüsselsatz  
 RUS Набор шестигранных
- CZ Imbusové klíče  
 RO Chei imbus  
 H Imbisz kulcs  
 E Juego de llaves hex



No.	mm	pcs	☐
56380	2-10	8	20/100
56390	1.5-10	10	20/100

- PL Zestaw kluczy imbusowych  
 GB Hex key set  
 D Sechskant-Stiftschlüsselsatz  
 RUS Набор шестигранных
- CZ Imbusové klíče  
 RO Chei imbus  
 H Imbisz kulcs  
 E Juego de llaves hex



No.	mm	pcs	☐
56391	1.5-10	10	20/100
56392	2-10	8	20/100

PL Zestaw kluczy imbusowych  
GB Hex key set  
D Sechskant-Stiftschluselsatz  
RUS Набор шестигранников

CZ Imbusové klíče  
RO Chei imbus  
H Imbisz kulcs  
E Juego de llaves hex

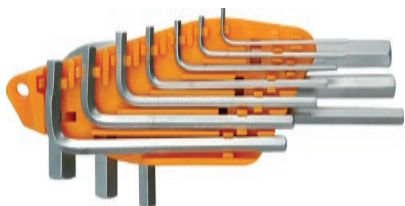

No.	mm	pcs	
56393	1.5; 2; 2.5; 3; 4; 5; 5.5; 6; 8; 10	10	10/60

PL Zestaw kluczy imbusowych  
GB Hex key set  
D Sechskant-Stiftschluselsatz  
RUS Набор шестигранников с шаром

CZ Imbusové klíče  
RO Chei imbus  
H Imbisz kulcs  
E Juego de llaves hex



No.	mm	pcs	
56470	2.5; 3; 4; 5; 6; 8; 10	7	20/40

PL Zestaw kluczy imbusowych  
GB Hex key set  
D Sechskant-Stiftschluselsatz  
RUS Набор шестигранников с шаром

CZ Imbusové klíče  
RO Chei imbus  
H Imbisz kulcs  
E Juego de llaves hex

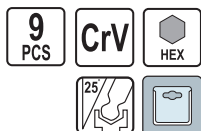

No.	mm	pcs	
56475	2.5; 3; 4; 5; 5.5; 6; 7; 8; 10	9	10/60

PL Zestaw kluczy imbusowych  
GB Hex key set  
D Sechskant-Stiftschluselsatz  
RUS Набор шестигранников с шаром

CZ Imbusové klíče  
RO Chei imbus  
H Imbisz kulcs  
E Juego de llaves hex

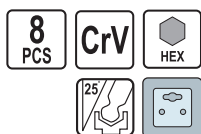

No.	mm	pcs	
56505	1.5; 2; 2.5; 3; 4; 5; 6; 8	8	25/100

PL Zestaw kluczy imbusowych  
GB Hex key set  
D Sechskant-Stiftschluselsatz  
RUS Набор шестигранников

CZ Imbusové klíče  
RO Chei imbus  
H Imbisz kulcs  
E Juego de llaves hex



No.	mm	pcs	
56400	2-14	10	20/40

PL Zestaw kluczy imbusowych  
GB Hex key set  
D Sechskant-Stiftschluselsatz  
RUS Набор шестигранников с шаром

CZ Imbusové klíče  
RO Chei imbus  
H Imbisz kulcs  
E Juego de llaves hex

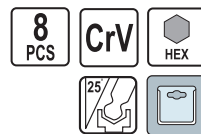

No.	mm	pcs	
56473	1.5; 2; 2.5; 3; 4; 5; 6; 8	8	10/60

PL Zestaw kluczy imbusowych  
GB Hex key set  
D Sechskant-Stiftschluselsatz  
RUS Набор шестигранников с шаром

CZ Imbusové klíče  
RO Chei imbus  
H Imbisz kulcs  
E Juego de llaves hex

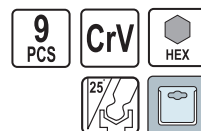

No.	mm	pcs	
56477	2; 2.5; 3; 4; 5; 5.5; 6; 8; 10	9	10/60

PL Zestaw kluczy imbusowych  
GB Hex key set  
D Sechskant-Stiftschluselsatz  
RUS Набор шестигранников

CZ Imbusové klíče  
RO Chei imbus  
H Imbisz kulcs  
E Juego de llaves hex

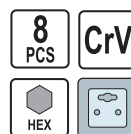

No.	mm	pcs	
56506	1.5; 2; 2.5; 3; 4; 5; 6; 8	8	25/100

PL Zestaw kluczy imbusowych  
 GB Hex key set  
 D Sechskant-Stiftschluselsatz  
 RUS Набор шестигранных

CZ Imbusové klíče  
 RO Chei imbus  
 H Imbissz kulcs  
 E Juego de llaves hex



No.	mm	size / rozmiar	pcs	
56550	1.3; 1.5; 2; 2.5; 3; 3.5; 4; 5; 5.5; 6; 7; 8; 10	1/20" (1.2 mm); 1/16" (1.6 mm); 5/64" (2.0 mm); 3/32" (2.4 mm); 7/64" (2.8 mm); 1/8" (3.2 mm); 5/32" (4.0 mm); 3/16" (4.8 mm); 7/32" (5.6 mm); 1/4" (6.3 mm); 5/16" (7.9 mm); 3/8" (9.5 mm)	25	25/50

PL Zestaw kluczy Torx  
 GB Torx key set  
 D Torx-Stiftschluselsatz  
 RUS Набор ключей Torx

CZ Souprava klíčů Torx  
 RO Set de chei Torx  
 H Kulcskészlet, Torx  
 E Juego de llaves Torx



No.		pcs	
56600	T10-T40	8	50/100

PL Zestaw kluczy Torx  
 GB Torx key set  
 D Torx-Stiftschluselsatz  
 RUS Набор ключей Torx

CZ Souprava klíčů Torx  
 RO Set de chei Torx  
 H Kulcskészlet, Torx  
 E Juego de llaves Torx



No.		pcs	
56478	T10; T15; T20; T25; T27; T30; T40; T45; T50	9	20/40

PL Zestaw kluczy Torx  
 GB Torx key set  
 D Torx-Stiftschluselsatz  
 RUS Набор ключей Torx

CZ Souprava klíčů Torx  
 RO Set de chei Torx  
 H Kulcskészlet, Torx  
 E Juego de llaves Torx



No.		pcs	
56507	T9 T10 T15 T20 T25 T27 T30 T40	8	25/100

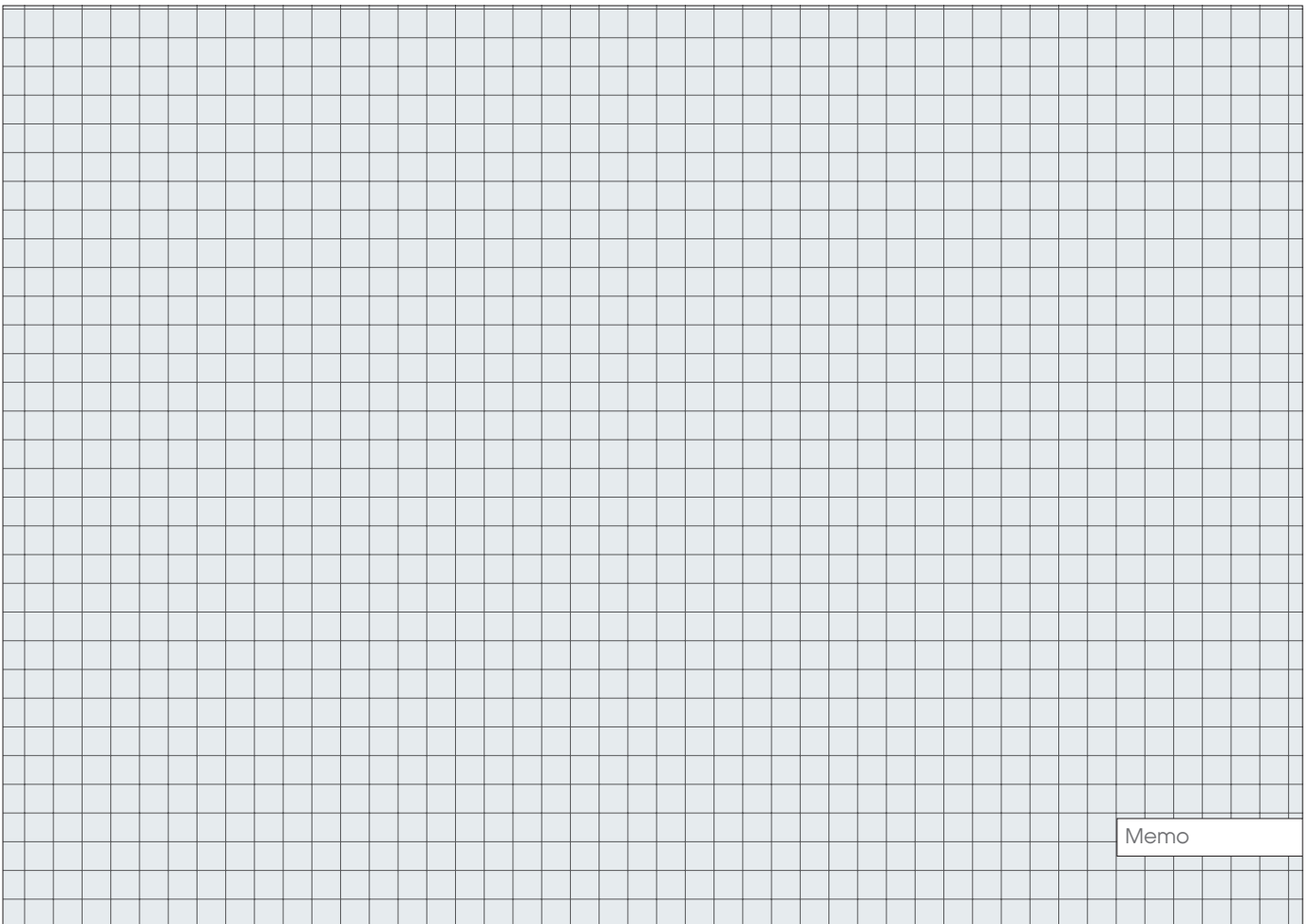

Memo

# 4

## Pliers & pipe wrenches Szczypce i klucze do rur





### Pliers, heavy duty blue handle Szczypce, uchwyt niebieski

40



#### Combination pliers

Szczypce uniwersalne..... 40

#### Side cutting pliers

Szczypce tnące, boczne..... 40

#### Long nose pliers

Szczypce wydłużone, proste..... 40

#### Bent nose pliers

Szczypce wydłużone, wygięte..... 40

### Pliers, 2 colour handle Szczypce, dwukolorowa rączka

40-41



#### Combination pliers

Szczypce uniwersalne..... 40

#### Side cutting pliers

Szczypce tnące, boczne..... 40

#### Long nose pliers

Szczypce wydłużone, proste..... 40

#### Bent nose pliers

Szczypce wydłużone, wygięte..... 40

#### Round nose pliers

Szczypce okrągłe..... 41

#### Wire stripping pliers

Szczypce do ściągania izolacji..... 41

#### End cutting pliers

Szczypce tnące, czołowe..... 41

#### Water pump pliers

Szczypce nastawne..... 41

### Chrome plated pliers Szczypce chromowane

41



#### Water pump pliers

Szczypce nastawne..... 41

### Pincers & pliers Szczypce i obcęgi

41-42



#### End cutting pliers

Szczypce tnące, czołowe..... 41

#### Carpenter's pincers

Obcęgi..... 41

#### Tower pincers

Szczypce tynkarskie..... 42

### Profile connection pliers Szczypce do łączenia profili

42



### Pliers „Juco” Szczypce „Juco”

42



#### Combination pliers

Szczypce uniwersalne..... 42

#### Side cutting pliers

Szczypce tnące, boczne..... 42

### Mini pliers

#### Szczypce „Mini”

42-43



#### Combination pliers

Szczypce uniwersalne..... 42

#### Side cutting pliers

Szczypce tnące, boczne..... 42

#### Long nose pliers

Szczypce wydłużone, proste..... 42

#### Bent nose pliers

Szczypce wydłużone, wygięte..... 43

#### Flat nose pliers

Szczypce płaskie..... 43

#### Round nose pliers

Szczypce okrągłe..... 43

#### End cutting pliers

Szczypce tnące, czołowe..... 43

#### Mini pliers sets

Zestawy szczypiec „Mini”..... 43

### Circlip pliers Szczypce Segera

43-45



### Lock grip pliers Szczypce zaciskowe

45



### Water pump pliers Szczypce nastawne

45



### Pipe wrenches Klucze do rur

46-47



#### Pipe wrenches Stillson type

Klucze do rur typu Stillson..... 46

#### Adjustable pipe wrenches

Klucze do rur nastawne..... 46

#### Adjustable wrenches

Klucze nastawne francuskie..... 47

### Chain pipe wrenches Klucze do rur łańcuchowe

47



PL Szczypce uniwersalne  
GB Combination pliers  
D Kombinationszange  
RUS Плоскогубцы универсальные

CZ Univerzální kleště  
RO Patent universal  
H Kombináltfogó  
E Alicates universal



**VOREL**

No.	L (mm)	
40010	160	6/60
40011	180	6/60
40012	200	6/60

PL Szczypce wydłużone proste  
GB Long nose pliers  
D Radiozange  
RUS Тонкогубцы

CZ Prodloužené kleště rovné  
RO Patent drept alungit  
H Rádiófogó, egyenes  
E Alicates de punta



**VOREL**

No.	L (mm)	
40013	160	6/120
40014	200	6/60

PL Szczypce uniwersalne  
GB Combination pliers  
D Kombinationszange  
RUS Плоскогубцы универсальные

CZ Univerzální kleště  
RO Patent universal  
H Kombináltfogó  
E Alicates universal



**VOREL**

No.	L (mm)	
40041	160	6/60
40042	180	6/60
40043	200	6/60

PL Szczypce wydłużone proste  
GB Long nose pliers  
D Radiozange  
RUS Тонкогубцы

CZ Prodloužené kleště rovné  
RO Patent drept alungit  
H Rádiófogó, egyenes  
E Alicates de punta



**VOREL**

No.	L (mm)	
40044	160	6/120
40045	180	6/60

PL Szczypce tnące boczne  
GB Diagonal side cutting pliers  
D Seitenschneider  
RUS Бокорезы

CZ Řezací kleště boční  
RO Patent de tăiat lateral  
H Oldal csípőfogó  
E Alicates corte lateral



**VOREL**

No.	L (mm)	
40017	160	6/60
40018	180	6/60

PL Szczypce wydłużone wygięte  
GB Bent nose pliers  
D Telefonzange  
RUS Тонкогубцы изогнутые

CZ Prodloužené kleště ohnuté  
RO Patent curbat alungit  
H Rádió- és telefonfogó, hajlított  
E Alicates curvos



**VOREL**

No.	L (mm)	
40015	160	6/120
40016	200	6/60

PL Szczypce tnące boczne  
GB Diagonal side cutting pliers  
D Seitenschneider  
RUS Бокорезы

CZ Řezací kleště boční  
RO Patent de tăiat lateral  
H Oldal csípőfogó  
E Alicates corte lateral



**VOREL**

No.	L (mm)	
40047	160	6/120
40048	180	6/60

PL Szczypce wydłużone wygięte  
GB Bent nose pliers  
D Telefonzange  
RUS Тонкогубцы изогнутые

CZ Prodloužené kleště ohnuté  
RO Patent curbat alungit  
H Rádió- és telefonfogó, hajlított  
E Alicates curvos



**VOREL**

No.	L (mm)	
40050	160	6/120
40051	180	6/60

PL Szcypce okrągłe  
GB Round nose pliers  
D Rundzange  
RUS Круглогубцы

CZ Kruhové kleště  
RO Patent rotund  
H Kerekcsőrű fogó  
E Alicates redondos

160 mm



No.	L (mm)	
40054	160	6/120

PL Szcypce tnące czolowe  
GB End cutting pliers  
D Vorschneider  
RUS Кусачки торцевые

CZ Řezací kleště čelní  
RO Clește de tăiat frontal  
H Homlok csípőfogó  
E Alicates corte frontal

160 mm



No.	L (mm)	
40055	160	6/60

PL Szcypce nastawne  
GB Water pump pliers  
D Wasserpumpenzange  
RUS Клещи переставные

CZ Hydraulické kleště nastavitelné  
RO Clește instalator tip papagal  
H Állítható csőfogó  
E Alicates de fontanero

250 mm



No.	L (mm)	
41500	250	6/60

PL Obcęgi  
GB Carpenter's pincers  
D Kneifzange  
RUS Клещи строительные

CZ Kleště  
RO Clește  
H Harapófogó  
E Tenazas



No.	L (mm)	
41151	180	6/60
41152	200	6/60

PL Szcypce do ściągania izolacji  
GB Wire stripping pliers  
D Abisolierzange  
RUS Клещи для снятия изоляции

CZ Kleště na sundávání izolace  
RO Patent pt. decablat  
H Szigeteléseltávolító fogó  
E Pinzas pelacables

160 mm



No.	L (mm)	
40056	160	6/60

PL Szcypce nastawne  
GB Water pump pliers  
D Wasserpumpenzange  
RUS Клещи переставные

CZ Hydraulické kleště nastavitelné  
RO Clește instalator tip papagal  
H Állítható csőfogó  
E Alicates de fontanero

250 mm



No.	L (mm)	
40057	250	6/60

PL Szcypce tnące czolowe  
GB End cutting pliers  
D Vorschneider  
RUS Кусачки торцевые

CZ Řezací kleště čelní  
RO Clește de tăiat frontal  
H Homlok csípőfogó  
E Alicates corte frontal

180 mm



No.	L (mm)	
41121	180	6/60

PL Obcęgi  
GB Carpenter's pincers  
D Kneifzange  
RUS Клещи строительные

CZ Kleště  
RO Clește  
H Harapófogó  
E Tenazas



No.	L (mm)	
41180	180	6/120
41200	200	6/60

PL Obcegi tynkarskie  
GB Tower pincers  
D Beisszange  
RUS Клеши штукатурные

CZ Kleště štípací čelní  
RO Clește pt. cuie  
H Rabitzfogó  
E Tenazas de enlucido

250  
mm



No.	L (mm)	Box
41381	250	6/60

PL Szczypce uniwersalne  
GB Combination pliers  
D Kombinationszange  
RUS Плоскогубцы универсальные

CZ Univerzální kleště  
RO Patent universal  
H Kombináltfogó  
E Alicates universal

1000  
V



No.	L (mm)	V	Box
40160	160	1000	10/50
40180	180	1000	10/50
40200	200	1000	10/50

PL Szczypce uniwersalne  
GB Combination pliers  
D Kombinationszange  
RUS Плоскогубцы

CZ Univerzální kleště  
RO Patent universal  
H Kombináltfogó  
E Alicates universal

120  
mm



No.	L (mm)	Box
42300	120	12/120

PL Szczypce wydłużone proste  
GB Long nose pliers  
D Radiozange  
RUS Тонкогубцы

CZ Prodloužené kleště rovné  
RO Patent drept alungit  
H Rádíofogó, egyenes  
E Alicates de punta

125  
mm



No.	L (mm)	Box
42303	125	12/120

PL Szczypce do łączenia profili  
GB Profile connection pliers  
D Zange zum Verbinden der Profile  
RUS Ципцы для соединения профилей

CZ Kleště ke spojování profilů  
RO Clește pt. îmbinarea profilelor  
H Profilgyesítő fogó  
E Pinzas para conectar perfiles

280  
mm

65  
Mn  
(PUNCH)

SECTION  
THICKNESS  
GRUBOSC  
PROFILU  
0,5-0,8 mm



No.	L (mm)	Box
04300	280	6/36

PL Szczypce tnące boczne  
GB Diagonal side cutting pliers  
D Seitenschneider  
RUS Бокорезы

CZ Řezací kleště boční  
RO Patent de tăiat lateral  
H Oldal csípőfogó  
E Alicates corte lateral

1000  
V

160  
mm



No.	L (mm)	V	Box
40700	160	1000	5/50

PL Szczypce tnące boczne  
GB Diagonal side cutting pliers  
D Seitenschneider  
RUS Бокорезы

CZ Řezací kleště boční  
RO Patent de tăiat lateral  
H Oldal csípőfogó  
E Alicates corte lateral

110  
mm



No.	L (mm)	Box
42301	110	12/120

PL Szczypce wydłużone proste  
GB Long nose pliers  
D Radiozange  
RUS Тонкогубцы

CZ Prodloužené kleště rovné  
RO Patent drept alungit  
H Rádíofogó, egyenes  
E Alicates de punta

150  
mm



No.	L (mm)	Box
42305	150	12/120

- PL Szcypce wydłużone wygięte  
 GB Bent nose pliers  
 D Telefonzange  
 RUS Тонкогубцы изогнутые  
 CZ Prodloužené kleště ohnuté  
 RO Patent curbat alungit  
 H Rádió- és telefonfogó hajlított  
 E Alicates curvos

125 mm



No.	L (mm)	Box icon
42304	125	12/120

- PL Szcypce okrągłe  
 GB Round nose pliers  
 D Rundzange  
 RUS Круглогубцы  
 CZ Kruhové kleště  
 RO Patent rotund  
 H Kerekcsőrű fogó  
 E Alicates redondos

125 mm



No.	L (mm)	Box icon
42307	125	12/120

- PL Zestaw mini szcypiec  
 GB Mini pliers set  
 D Mini-zangensatz  
 RUS Пассатижи в наборе  
 CZ Elektronické kleště  
 RO Set mini patenti  
 H Elektronikai fogó  
 E Alicates electronicas

4 PCS



No.	pcs	Box icon
42308	4	25/50

- PL Szcypce Segera, zewnętrzne proste  
 GB Circlip pliers, external straight  
 D Seegeringzange aussen. ger.  
 RUS Съёмник стопорных колец (разжим)  
 CZ Kleště Segera vnější rovné  
 RO Clește Seger exterior drept  
 H Segerfogó külső, egyenes  
 E Alicates Seger exter. de punta



No.	L (mm)	Box icon
43010	150	6/120
43011	200	6/120

- PL Szcypce płaskie  
 GB Flat nose pliers  
 D Elektrikerflachzange  
 RUS Утконосы

- CZ Prodloužené kleště rovné  
 RO Clește cu vârf ascuțit  
 H Rádiófogó, egyenes  
 E Alicates de bocas planas

120 mm



No.	L (mm)	Box icon
42306	120	12/120

- PL Szcypce tnące czolowe  
 GB End cutting pliers  
 D Vorschneider  
 RUS Кусачки торцевые  
 CZ Řezací kleště čelní  
 RO Clește de tăiat frontal  
 H Homlok csípőfogó  
 E Alicates corte frontal

110 mm



No.	L (mm)	Box icon
42302	110	12/120

- PL Zestaw mini szcypiec  
 GB Mini pliers set  
 D Mini-zangensatz  
 RUS Пассатижи в наборе  
 CZ Elektronické kleště  
 RO Set mini patenti si clesiti  
 H Elektronikai fogó  
 E Alicates electronicas

6 PCS



No.	pcs	Box icon
42309	6	10/40

- PL Szcypce Segera, zewnętrzne wygięte  
 GB Circlip pliers, external bent  
 D Seegeringzange aussen. geb.  
 RUS Съёмник стопорных колец (разжим)-изогнутый  
 CZ Kleště Segera vnější ohnuté  
 RO Clește Seger exterior curbat  
 H Segerfogó külső, hajlított  
 E Alicates seger exter. curvos



No.	L (mm)	Box icon
43020	150	6/120
43021	200	6/120

PL Szczypce Segera, wewnętrzne proste  
 GB Circlip pliers, internal straight  
 D Seegeringzange inner. ger.  
 RUS Съёмник стопорных колец (сжим)

CZ Kleště Segera vnitřní rovné  
 RO Clește Seger interior drept  
 H Segerfogó belső, egyenes  
 E Alicates seger inter. de punta



No.	L (mm)	
43030	150	6/120
43031	200	6/120

PL Szczypce Segera, zewnętrzne proste  
 GB Circlip pliers, external straight  
 D Seegeringzange aussen. ger.  
 RUS Съёмник стопорных колец (разжим)

CZ Kleště Segera vnější rovné  
 RO Clește Seger exterior drept  
 H Segerfogó külső, egyenes  
 E Alicates seger exter. de punta



No.	L (mm)	
43050	160	6/60
43055	180	6/60
43060	200	6/60

PL Szczypce Segera, wewnętrzne proste  
 GB Circlip pliers, internal straight  
 D Seegeringzange inner. ger.  
 RUS Съёмник стопорных колец (сжим)

CZ Kleště Segera vnitřní rovné  
 RO Clește Seger interior drept  
 H Segerfogó belső, egyenes  
 E Alicates seger inter. de punta

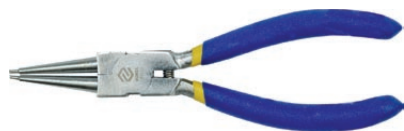

No.	L (mm)	
43052	160	6/60
43057	180	6/60
43062	200	6/60

PL Szczypce Segera  
 GB Circlip pliers set  
 D Seegeringzangen satz  
 RUS Набор съёмников стопорных колец

CZ Kleště Segera  
 RO Set clești seger  
 H Segerfogó  
 E Alicates seger



No.	L (mm)	pcs	
43140	150	4	5/30

PL Szczypce Segera, wewnętrzne wygięte  
 GB Circlip pliers, internal bent  
 D Seegeringzange inner. geb.  
 RUS Съёмник стопорных колец (сжим)-изогнутый

CZ Kleště Segera vnitřní ohnuté  
 RO Patent seger interior curbat  
 H Segerfogó belső, hajlított  
 E Alicates Seger inter. curvos



No.	L (mm)	
43040	150	6/120
43041	200	6/120

PL Szczypce Segera, zewnętrzne wygięte  
 GB Circlip pliers, external bent  
 D Seegeringzange aussen. geb.  
 RUS Съёмник стопорных колец (разжим)

CZ Kleště Segera vnější ohnuté  
 RO Clește Seger exterior curbat  
 H Segerfogó külső, hajlított  
 E Alicates seger exter. curvos

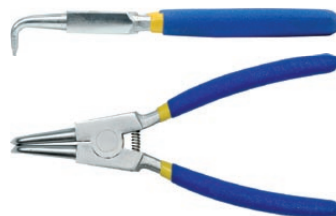

No.	L (mm)	
43051	160	6/60
43056	180	6/60
43061	200	6/60

PL Szczypce Segera, wewnętrzne wygięte  
 GB Circlip pliers, internal bent  
 D Seegeringzange inner. geb.  
 RUS Съёмник стопорных колец (сжим)

CZ Kleště Segera vnitřní ohnuté  
 RO Patent Seger interior curbat  
 H Segerfogó belső, hajlított  
 E Alicates Seger inter. curvos

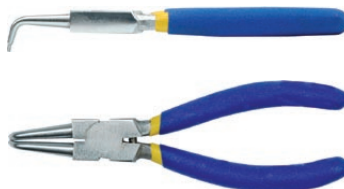

No.	L (mm)	
43053	160	6/60
43058	180	6/60
43063	200	6/60

PL Szczypce Segera  
 GB Circlip pliers set  
 D Seegeringzangen satz  
 RUS Набор съёмников стопорных колец

CZ Kleště Segera  
 RO Clește pt. inele de siguranță + capete de schimb  
 H Segerfogó  
 E Alicates seger



No.	L (mm)	pcs	
43500	150	4	6/60

- PL Szczypce Segera  
GB Circlip pliers set  
D Seegeringzangen satz  
RUS Съёмник стопорных колец
- CZ Kleště Segera  
RO Clește pt. inele de siguranță + capete de schimb  
H Seegerfogó  
E Alicates seger

5  
PCS

150  
mm





No.	L (mm)	pcs	
43510	150	5	6/60

- PL Szczypce Morse'a  
GB Lock grip pliers  
D Gripzange  
RUS Зажим ручной
- CZ Kleště Morse'a  
RO Clește Morse  
H Morse fogó  
E Alicates Morse

250  
mm



No.	L (mm)	
44102	250	6/36

- PL Szczypce zaciskowe klamrowe typu „C”  
GB Welding locking pliers „C” type  
D Klemm- und Klammerzange vom Typ „C”  
RUS Клещи зажимные сварочные
- CZ Kleště samosvorné upínací typu „C”  
RO Clește de strângere cu cleșă tip „C”  
H „C” fogó  
E Pinzas de tornillo (de apriete) de grapa tipo „C”

280  
mm

0-70  
mm

TYPE  
C



**VOREL**

No.	L (mm)	type	
44301	280	C	6/30

- PL Szczypce spawalnicze  
GB Lock grip pliers  
D Schweisserzange  
RUS Клещи зажимные сварочные
- CZ Svářečské kleště  
RO Clește autoblocant pt. sudura  
H Hegesztő fogó  
E Alicates de soldar

250  
mm





No.	L (mm)	type	
44500	250	SM	6/36

- PL Szczypce Morse'a  
GB Lock grip pliers  
D Gripzange  
RUS Зажим ручной
- CZ Kleště Morse'a  
RO Clește Morse  
H Morse fogó  
E Alicates Morse

250  
mm





No.	L (mm)	
44100	250	6/60

- PL Szczypce spawalnicze  
GB Lock grip pliers  
D Schweisserzange  
RUS Клещи зажимные сварочные
- CZ Svářečské kleště  
RO Clește autoblocant pt. sudura  
H Hegesztő fogó  
E Alicates de soldar

TYPE  
C

275  
mm





No.	L (mm)	type	
44300	275	C	6/36

- PL Szczypce spawalnicze  
GB Lock grip pliers  
D Schweisserzange  
RUS Клещи зажимные сварочные
- CZ Svářečské kleště  
RO Clește autoblocant pt. sudura  
H Hegesztő fogó  
E Alicates de soldar

225  
mm



No.	L (mm)	type	
44400	225	W	6/36

- PL Szczypce hydrauliczne nastawne  
GB Water pump pliers  
D Wasserpumpenzange  
RUS Клещи переставные
- CZ Keleště siko  
RO Clește papagal  
H Vízpumpafogó  
E Alicates de fontanero ajustables

250  
mm

9mm  
JAWS WIDTH  
GRUBOS: SZCZĘKI

7  
POSITIONS  
POZYCJI





**VOREL**

No.	L (mm)	
41510	250	10/50

PL Klucz do rur  
GB Pipe wrench  
D Rohrschlüssel  
RUS Ключ трубный

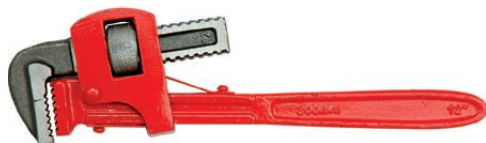
CZ Klíč součásti na trubky  
RO Chei pt. țevi  
H Csőkulcs  
E Llave de fontanero



No.	L (mm)	
55250	250	6/48
55300	300	6/36
55350	350	6/24

PL Klucz nastawny do rur  
GB Adjustable pipe wrench  
D Rohrschlüssel  
RUS Ключ трубный

CZ Nastavitelný klíč na trubky  
RO Cheie reglabilă pt. țevi  
H Állítható csőkulcs  
E Llave de vaso para tubería

45°



No.	size / rozmiar	
55100	1.0" (25 mm)	12/36
55150	1.5" (38 mm)	10/20
55200	2.0" (50 mm)	6/12

PL Klucz nastawny do rur  
GB Adjustable pipe wrench  
D Rohrschlüssel  
RUS Ключ трубный

CZ Nastavitelný klíč na trubky  
RO Cheie reglabilă pt. țevi  
H Állítható csőkulcs  
E Llave de vaso para tubería

90°



VOREL

No.	size / rozmiar	
55215	1.0" (25 mm)	24
55216	1.5" (38 mm)	16
55217	2.0" (50 mm)	8

PL Klucz do rur  
GB Pipe wrench  
D Rohrschlüssel  
RUS Ключ трубный

CZ Klíč součásti na trubky  
RO Chei pt. țevi  
H Csőkulcs  
E Llave de fontanero



VOREL

No.	L (mm)	
55620	200	6/60
55625	250	6/36
55630	300	6/24
55635	350	4/16
55645	450	3/12
55660	600	3/6
55690	900	2/4

PL Klucz nastawny do rur  
GB Adjustable pipe wrench  
D Rohrschlüssel  
RUS Ключ трубный

CZ Nastavitelný klíč na trubky  
RO Cheie reglabilă pt. țevi  
H Állítható csőkulcs  
E Llave de vaso para tubería

45°



VOREL

No.	size / rozmiar	
55210	1.0" (25 mm)	24
55211	1.5" (38 mm)	16
55212	2.0" (50 mm)	8

PL Klucz nastawny do rur  
GB Adjustable pipe wrench  
D Rohrschlüssel  
RUS Ключ трубный

CZ Nastavitelný klíč na trubky  
RO Cheie reglabilă pt. țevi  
H Állítható csőkulcs  
E Llave de vaso para tubería

S



VOREL

No.	size / rozmiar	
55220	1.0" (25 mm)	24
55221	1.5" (38 mm)	16
55222	2.0" (50 mm)	8



PL Klucz nastawny francuski  
 GB Adjustable wrench  
 D Stahlschraubenschlüssel /franzose/  
 RUS Ключ разводной

CZ Nastavitelný klíč francúz  
 RO Cheie reglabilă franceză  
 H Állítható franciakułcs  
 E Llave ajustable inglesa



No.	KNF	jaws range / zakres szczęk (mm)	jaws width / szerokość szczęk (mm)	
54499	45	0-45	80	10
54500	55	0-55	90	5
54510	65	0-65	100	5

PL Klucz łańcuchowy do rur  
 GB Chain pipe wrench  
 D Kettenrohrzange  
 RUS Цепной ключ для труб

CZ Klíč řetězový na trubky  
 RO Cheie reglabilă pt. tevi cu lant  
 H Láncos csőfogó  
 E Llave de cadena

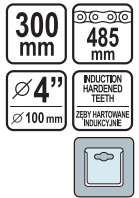

No.	L (mm)	max. pipe diameter / max. średnica rury	
55792	300	4" (100 mm)	30

Memo

# 5

## Electrician tools Narzędzia dla elektryków

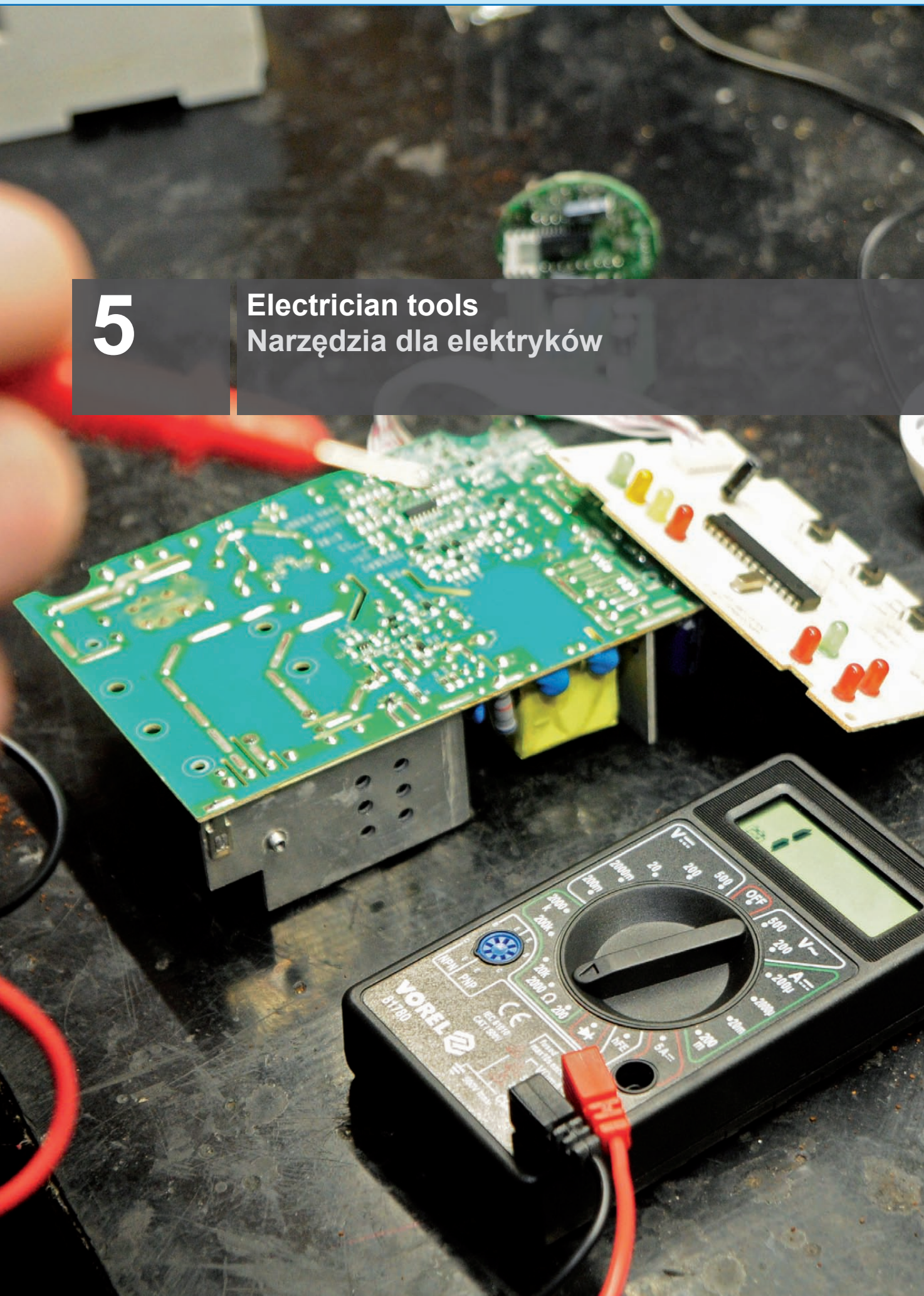

**Crimping pliers**  
Szczypce do zaciskania  
konektorów

50



**Ratchet crimping pliers**  
Szczypce do zaciskania  
konektorów z grzechotką

50



**Wire strippers**  
Ściągacze izolacji

50-51



**Electrical cutters**  
Obcinaki elektryczne

51



**Voltage testers**  
Próbniki napięcia

51



**Digital universal meters**  
Cyfrowe mierniki uniwersalne

51-52



5

- PL Szczypce do zaciskania konektorów  
 GB Ratchet crimping pliers  
 D Kabelschuhzange  
 RUS Инструмент для обжима и зачистки проводов  
 CZ Kleště pro svěrání zaciskania konektorů  
 RO Clește sertizat conectori  
 H Krimpelő fogó  
 E Pinzas de apretar de conectores



220 mm



5 VOREL

No.	L (mm)	mm <sup>2</sup>	AWG	Box
45500	220	0.5-2.5	20-14	12/36

- PL Szczypce do zaciskania konektorów  
 GB Ratchet crimping pliers  
 D Kabelschuhzange  
 RUS Электрорассадки
- CZ Kleště pro svěrání zaciskania konektorů  
 RO Clește sertizat conectori  
 H Krimpelő fogó  
 E Pinzas de apretar de conectores



210 mm



No.	L (mm)	Box
45000	210	12/120

- PL Automatyczny ściągacz izolacji  
 GB Wire stripper / crimper  
 D Automatische abisolierzange  
 RUS Клещи-автомат для снятия изоляции
- CZ Automatický stahovač izolace  
 RO Decablator automat  
 H Automatikus szigeteléslehúzó  
 E Pelacables automatico



165 mm



No.	L (mm)	Box
45100	165	20/100

- PL Automatyczny ściągacz izolacji  
 GB Wire stripper / crimper  
 D Automatische abisolierzange  
 RUS Клещи-автомат для зачистки изоляции
- CZ Automatický stahovač izolace  
 RO Decablator automat  
 H Automatikus szigeteléslehúzó  
 E Pelacables automatico

180 mm

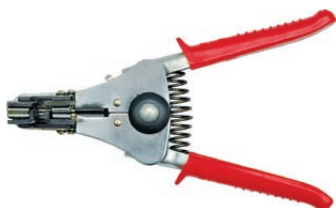

No.	L (mm)	Box
45150	180	6/60

- PL Szczypce do zaciskania konektorów  
 GB Ratchet crimping pliers  
 D Kabelschuhzange  
 RUS Пассатики для телефонных кабелей  
 CZ Kleště pro svěrání zaciskania konektorů  
 RO Clește sertizat conectori  
 H Krimpelő fogó  
 E Pinzas de apretar de conectores

12 x RJ45

12 x RJ11

2.5m



VOREL

No.	Box
45503	10/40

- PL Zaciskacz z konektorami w kasie  
 GB Solderless terminal kit  
 D Kabelschuhzange u. kabelschuhe  
 RUS Клещи для обжима + изолированные наконечники
- CZ Svěrka z konektorama v kazetě  
 RO Set cleste mufare plus conectori  
 H Présszerszám csatlakozókkal egy dobozban  
 E Apretador con conectores en caja



100 PCS



No.	pcs	Box
45050	100	25/50

- PL Automatyczny ściągacz izolacji  
 GB Wire stripper / crimper  
 D Automatische abisolierzange  
 RUS Клещи-автомат для снятия изоляции
- CZ Automatický stahovač izolace  
 RO Decablator automat  
 H Automatikus szigeteléslehúzó  
 E Pelacables automatico

170 mm



VOREL

No.	L (mm)	mm	Box
45103	170	0.2-5.5	12/48

- PL Automatyczny ściągacz izolacji  
 GB Wire stripper / crimper  
 D Automatische abisolierzange  
 RUS Клещи-автомат для снятия изоляции
- CZ Automatický stahovač izolace  
 RO Decablator automat  
 H Automatikus szigeteléslehúzó  
 E Pelacables automatico

160 mm



17-12 (AWG)  
1.0-3.2 mm (GAW)



VOREL

No.	L (mm)	mm	Box
45151	160	1.0-3.2	10/50

PL Automacyjny ściągacz z obcinakiem  
 GB Automatic wire stripper with cutter  
 D Automatische abisolierzange + Schneider  
 RUS Клещи-автомат для снятия изоляции

CZ Automatický stahovač izolace  
 RO Decablator automat  
 H Automatikus szigeteléselhúzó  
 E Pelacables automatico

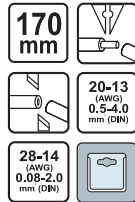

No.	L (mm)	Box
45201	170	10/50

PL Ściągacz izolacji  
 GB Wire stripper  
 D Abisolierzange  
 RUS Электрорассчитки

CZ Odizolovací klejste  
 RO Decablator  
 H Blankolo fogo  
 E Extractor de aislado

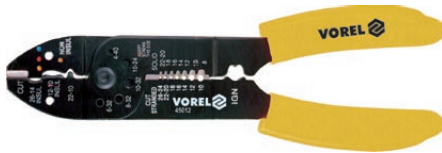
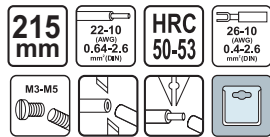

No.	L (mm)	Box
45012	215	12/72

PL Nożyczki dla elektryków  
 GB Electrician scissors  
 D Spannungsprüfer  
 RUS Ножницы электрика

CZ Univerzální nůžky  
 RO Foarface universal  
 H Univerzális olló  
 E Tijeras universales



No.	L (mm)	Box
76320	140	12/120

PL Próbник napięcia  
 GB Voltage tester  
 D Spannungsprüfer  
 RUS Отвёртка индикаторная

CZ Zkoušeč napětí  
 RO Creion de tensiune  
 H Fáziskereső  
 E Comprobador de corriente



No.	L (mm)	Box
65235	190	12/600

PL Ściągacz izolacji  
 GB Wire stripper  
 D Abisolierzange  
 RUS Съёмник изоляции

CZ Odizolovací klejste  
 RO Decablator  
 H Blankolo fogo  
 E Extractor de aislado

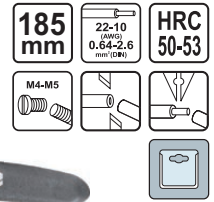

No.	L (mm)	Box
45010	185	12/120

PL Obcinak elektryczny  
 GB Electrical cutter  
 D Seitenschneider  
 RUS Щипцы для резки проводов

CZ Elektrický upichovač ze stahovačlem  
 RO Clește tăietor - electrician  
 H Kábelvágó  
 E Cortacables eléctricos



No.	L (mm)	Box
45020	135	12/120

PL Próbnik napięcia  
 GB Voltage tester  
 D Spannungsprüfer  
 RUS Отвёртка индикаторная

CZ Zkoušeč napětí  
 RO Creion de tensiune  
 H Fáziskereső  
 E Comprobador de corriente



No.	L (mm)	Box
65233	140	12/1200

PL Cyfrowy miernik uniwersalny  
 GB Digital universal multimeter  
 D Universal digital multimeter  
 RUS Универсальный цифровой мультиметр  
 CZ Digitální multimetr - univerzální  
 RO Multimetru digital universal  
 H Digitális multiméter  
 E Manómetro digital universal

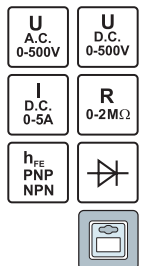

No.	Box
81780	12/72

- PL Cyfrowy miernik uniwersalny
- GB Digital universal multimeter
- D Universal digital multimeter
- RUS Универсальный цифровой мультиметр
- CZ Digitální multimetr - univerzální
- RO Multimetru digital universal
- H Digitális multiméter
- E Manòmetor digital universal



- U**  
A.C.  
0-750V
- U**  
D.C.  
0-1000V
- I**  
A.C.  
0-20A
- I**  
D.C.  
0-20A
- R**  
0-200  
MΩ
- C**  
0-20μF
- 
- h<sub>FE</sub>**  
PNP  
NPN
- 
- AUTO  
POWER  
OFF**
- 

- PL Cyfrowy miernik uniwersalny
- GB Digital universal multimeter
- D Universal digital multimeter
- RUS Универсальный цифровой мультиметр
- CZ Digitální multimetr - univerzální
- RO Multimetru digital universal
- H Digitális multiméter
- E Manòmetor digital universal



- U**  
A.C.  
0-750V
- U**  
D.C.  
0-1000V
- I**  
A.C.  
0-20A
- I**  
D.C.  
0-20A
- R**  
0-200  
MΩ
- C**  
0-20μF
- 
- h<sub>FE</sub>**  
PNP  
NPN
- f**  
20KHz  
max
- T**  
-40+  
1000°C
- 
- AUTO  
POWER  
OFF**
- 

5



No.	digit height / wysokość cyfr (mm)	
81783	25	20



No.	digit height / wysokość cyfr (mm)	
81784	25	20

Memo



Memo

# 6

## Hammers, chisels, punches & axes Młotki, dłuta, przecinaki i siekiery





## Machinist hammers Młotki ślusarskie



56-57

**Machinist hammers with wooden handle**  
Młotki ślusarskie z rączką drewnianą..... 56

**Machinist hammers with fibreglass handle**  
Młotki ślusarskie z rączką z włókna szklanego..... 56

**Machinist hammers „Juco”**  
Młotki ślusarskie „Juco”..... 56

**Brick hammers „Juco”**  
Młotki murarskie „Juco”..... 57

**Welder’s hammers „Juco”**  
Młotki spawalnicze „Juco”..... 57

## Stoning hammers Młotki kamieniarskie



57

**Stoning hammers „Juco”**  
Młotki kamieniarskie „Juco”..... 57

## Hammers with tubular steel handle Młotki z trzonkiem rurowym



57-58

**Claw hammers**  
Młotki szewskie..... 57

**Roofing hammers**  
Młotki ciesielskie..... 57

**Mason’s hammers**  
Młotki murarskie..... 58

## Hammers with fibreglass handle Młotki z rączką z włókna szklanego



58

**Claw hammers**  
Młotki szewskie..... 58

**Roofing hammers**  
Młotki ciesielskie..... 58

## Rubber mallets Młotki gumowe



58-59

**Rubber mallets with wooden handle**  
Młotki gumowe z rączką drewnianą..... 58

**Rubber mallets with tubular steel handle**  
Młotki gumowe z rączką stalową..... 58

**Rubber mallets with fibreglass handle**  
Młotki gumowe z rączką z włókna szklanego..... 58

**Soft faced mallets**  
Młotki blacharskie gumowo-plastyczne..... 59

## Chisels, cold chisels, punches & wrecking bars Dłuta, przecinaki, przebijaki i łomy



59-61

**Wood chisels with wooden handle**  
Dłuta stolarskie z rączką drewnianą..... 59

**Wood chisels with plastic handle**  
Dłuta stolarskie z rączką z tworzywa..... 59

**Curving chisels**  
Dłuta snycerskie..... 59

**Cold chisels**  
Przecinaki..... 59

**Cold chisels „Juco”**  
Przecinaki „Juco”..... 60

**Punches**  
Przebijaki..... 60

**Wrecking bars**  
Łomy..... 60

**Wrecking bars „Juco”**  
Łomy „Juco”..... 61

## Axes Siekiery



61-62

**Axes with wooden handle**  
Siekiery z trzonkiem drewnianym..... 61

**Axes with fibreglass handle**  
Siekiery z trzonkiem z włókna szklanego..... 61

**Axes „Juco”**  
Siekiery „Juco”..... 61

## Picaxes Kilofy



62-63

**Pickaxes**  
Kilofy..... 62

**Wood splitters „Juco”**  
Kliny do rozłupywania drewna „Juco”..... 63

PL Młotek ślusarski  
GB Machinist hammer  
D Schlosserhammer  
RUS Молоток слесарный

CZ Zámečnické kladívko  
RO Ciocan de lăcătușerie  
H Vaskalapács  
E Martillo



No.	g	
30010	100	12/120
30020	200	12/72
30030	300	12/60
30040	400	6/48
30050	500	6/36
30060	600	6/36
30080	800	6/24
30100	1000	6/24
30150	1500	6/12
30200	2000	6/12

PL Młotek ślusarski  
GB Machinist hammer  
D Schlosserhammer  
RUS Молоток слесарный

CZ Zámečnické kladívko  
RO Ciocan de lăcătușerie  
H Vaskalapács  
E Martillo

DIN 1042



No.	kg	
30531	3	1
30532	4	1
30533	5	1
30534	6	1
30535	8	1
30536	10	1

PL Młotek ślusarski  
GB Machinist hammer  
D Schlosserhammer  
RUS Молоток слесарный

CZ Zámečnické kladívko  
RO Ciocan de lăcătușerie  
H Vaskalapács  
E Martillo

DIN 1041



JUCO

No.	kg	
31010	0.1	10
31030	0.3	10
31050	0.5	10
31070	0.7	10
31100	1.0	10
31150	1.5	6
31200	2.0	6

PL Młotek ślusarski  
GB Machinist hammer  
D Schlosserhammer  
RUS Молоток слесарный

CZ Zámečnické kladívko  
RO Ciocan de lăcătușerie  
H Vaskalapács  
E Martillo



VOREL

No.	g	
30410	100	12/120
30420	200	6/60
30430	300	6/60
30440	400	6/48
30450	500	6/36
30460	600	6/36
30480	800	6/24
30500	1000	6/24
30510	1500	6/12
30520	2000	6/12

PL Młotek ślusarski, rączka z włókna szklanego  
GB Machinist hammer with fibreglass + PVC handle  
D Schlosserhammer Fibreglasstiel  
RUS Молоток со стеклопластиковой ручкой

CZ Zámečnické kladívko  
RO Ciocan de lăcătușerie  
H Vaskalapács  
E Martillo



VOREL

No.	g	
30310	100	6/120
30320	200	6/36
30330	300	6/48
30340	400	6/36
30350	500	6/36
30360	600	6/36
30380	800	6/24
30390	1000	6/24
30395	1500	6/12
30400	2000	6/12

PL Młotek ślusarski  
GB Machinist hammer  
D Schlosserhammer  
RUS Молоток слесарный

CZ Zámečnické kladívko  
RO Ciocan de lăcătușerie  
H Vaskalapács  
E Martillo

DIN 1042



JUCO

No.	kg	
31300	3.0	1
31400	4.0	1
31500	5.0	1
31600	6.0	1
31800	8.0	1
32000	10.0	1

PL Młotek ślusarski  
GB Machinist hammer  
D Schlosserhammer  
RUS Молоток слесарный

CZ Zámečnické kladívko  
RO Ciocan de lăcătuşerie  
H Vaskalapács  
E Martillo



JUCO

No.	g	
29992	300	5
29993	500	5
29994	700	5
29995	1000	5
29996	1500	5
29997	2000	5

PL Młotek spawalniczy  
GB Welder's hammer  
D Schweisserhammer  
RUS Молоток сварщика

CZ Svářečské kladívko  
RO Ciocan de sudură  
H Hegesztő kalapács  
E Martillo para soldar



JUCO

No.	g	
32110	350	5

PL Młotek szewski, rączka ze stali  
GB Claw hammer with tubular steel handle  
D Klauenhammer  
RUS Молоток-гвоздодел с металлической  
обрезиненной рукояткой

CZ Ševcovské kladívko  
RO Ciocan de cizmărie  
H Cipész kalapács  
E Martillo sacador mango de acero



VOREL

No.	g	
32625	600	6/24

PL Młotek murarski  
GB Brick hammer  
D Maurerhammer  
RUS Молоток каменщика

CZ Zednické kladívko  
RO Ciocan de zidărie  
H Kőműves kalapács  
E Martillo albañil



JUCO

No.	g	
32720	700	5

PL Młotek kamieniarski  
GB Safety stoning hammer  
D Fäustel  
RUS Кувалда двухбубновая

CZ Palička kovová  
RO Ciocan pt. zidărie  
H Kőtörő kalapács  
E Martillo



JUCO

No.	kg	
32201	1.5	6
32202	2.0	6
32203	3.0	1
32204	4.0	1
32205	5.0	1
32206	6.0	1
32207	8.0	1
32208	10.0	1

PL Młotek ciesielski, rączka ze stali  
GB Roofing hammer with tubular steel handle  
D Lattenhammer  
RUS Молоток кровельщика

CZ Tesařské kladívko  
RO Ciocan de dulgherie  
H Ácskalapács  
E Martillo sacador mango de acero



VOREL

No.	g	
32685	600	6/24

- PL Młotek murarski berliński, rączka ze stali  
 GB Mason's hammer type „B” with tubular steel handle  
 D Berliner mauerhammer  
 RUS Молоток каменщика
- CZ Zednické kladívko berlińské  
 RO Ciocan de zidărie tip Berlin  
 H Kőműves kalapács, berlini típus  
 E Martillo berlin mango de acero



No.	g	
32705	600	6/24

6

- PL Młotek szewski, rączka z włókna szklanego  
 GB Claw hammer with fibreglass + PVC handle  
 D Klauenhammer fiberglasstiel  
 RUS Молоток гвоздодер со стеклопластиковой ручкой  
 CZ Kladivo ševcovské, ručka ze skleněných vláken  
 RO Cican pt. cismari, cu mânier din fibră de sticlă  
 H Cipész kalapács  
 E Martillo sacador con mango de fibra de vidrio



No.	g	
32627	600	6/24

- PL Młotek gumowy  
 GB Rubber mallet  
 D Gummihammer  
 RUS Киянка резиновая
- CZ Pryžové kladívko  
 RO Ciocan de cauciuc  
 H Gumikalapács  
 E Mazo de goma



No.	mm	
33550	45	36/72
33650	55	12/60
33900	70	12/24

- PL Młotek gumowy, rączka z włókna szklanego  
 GB Rubber mallet with fibreglass + PVC handle  
 D Gummihammer fiberglasstiel  
 RUS Киянка резиновая с фиберглассовой ручкой
- CZ Pryžové kladívko  
 RO Ciocan de cauciuc  
 H Gumikalapács  
 E Mazo de goma



- PL Młotek murarski reński, rączka ze stali  
 GB Mason's hammer type „R” with tubular steel handle  
 D Mauerhammer rheinische form  
 RUS Молоток каменщика
- CZ Zednické kladívko reńské  
 RO Ciocan de zidărie  
 H Kőműves kalapács, rajnai típus  
 E Martillo rin mango de acero



No.	g	
32715	600	6/24

- PL Młotek ciesielski, rączka z włókna szklanego  
 GB Roofing hammer with fibreglass + PVC handle  
 D Lattenhammer fiberglasstiel  
 RUS Молоток кровельщика  
 CZ Kladivo tesářské, ručka ze skleněných vláken  
 RO Ciocan de dulgherie  
 H Ácskalapács  
 E Martillo de carpintero con mango de fibra de vidrio



No.	g	
32687	600	6/24

- PL Młotek gumowy z rączką stalową  
 GB Rubber mallet with steel handle  
 D Gummihammer stahlstiel  
 RUS Киянка резиновая
- CZ Pryžové kladívko  
 RO Ciocan de cauciuc  
 H Gumikalapács  
 E Mazo de goma



No.	mm	
33557	50	6/60
33657	56	12/48
33907	66	6/24
33927	76	6/24

- PL Młotek gumowy, rączka z włókna szklanego  
 GB Rubber mallet with fibreglass + PVC handle  
 D Gummihammer fiberglasstiel  
 RUS Киянка резиновая с фиберглассовой ручкой
- CZ Pryžové kladívko  
 RO Ciocan de cauciuc  
 H Gumikalapács  
 E Mazo de goma



No.	mm	
33535	45	6/60
33555	50	6/48
33655	56	6/30
33905	66	6/24
33925	76	6/24

PL Młotek blacharski, guma - plastik  
 GB Soft faced mallet  
 D Ausbeulhammer  
 RUS Молоток рихтовочный комбинированный с деревянной ручкой

CZ Klempířské kladívko  
 RO Ciocan pt. tabla  
 H Bádógos kalapács  
 E Mazo goma-plastico

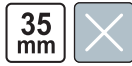

No.	mm	Box
33950	35	30/60

PL Dłuto  
 GB Chisel  
 D Stechbeitel  
 RUS Стамеска с ударной головкой

CZ Řezbářské dláto  
 RO Dalță de tâmplărie  
 H Asztalos véső  
 E Cincel con mango transparente



No.	mm	Box
25510	6	5/100
25511	8	5/100
25512	10	5/100
25513	12	5/100
25514	14	5/100
25515	15	5/100
25516	18	5/100
25517	20	5/100
25518	22	5/100
25519	25	5/100
25520	32	5/100
25521	38	5/100

PL Przecinak płaski z osłoną  
 GB Octagonal cold chisel with protection  
 D Flachmeißel mit hanschutz  
 RUS Зубило с протектором

CZ Plochý sekáč /z krytem/  
 RO Dalta zidarie cu protectie  
 H Hidegvágó /védőfejjel/  
 E Cincel plano /con protector/



No.	L (mm)	Box
35250	250	12/72
35300	300	12/48

PL Zestaw dłut stolarskich  
 GB Wood chisel set  
 D Stech-beitelsatz  
 RUS Набор стамесок

CZ Zámečnické dláta  
 RO Dalte de tâmplărie  
 H Asztalos véső  
 E Cinceles de carpintero



No.	pcs	Box
25500	4	10/40

PL Zestaw dłut do drewna  
 GB Wood chisel set  
 D Stechbeitelsatz  
 RUS Набор стамесок по дереву  
 CZ Zámečnické dláta  
 RO Set dalți  
 H Asztalos véső  
 E Juego de cinceles



No.	mm	pcs	Box
25530	6; 12; 18; 24	4	10/40

PL Zestaw dłut snycerskich  
 GB Curving chisel set  
 D Holzschnittwerkzeugsatz  
 RUS Набор фигурных стамесок для резьбы по дереву

CZ Řezbářské dláta  
 RO Dalte curbate cu mâner din lemn  
 H Finom véső  
 E Cinceles mango de madera



No.	pcs	Box
25700	6	15/60

PL Przecinak z osłoną  
 GB Cold chisel with protection  
 D Flachmeißel mit hanschutz  
 RUS Зубило с протектором

CZ Sekáč /z krytem/  
 RO Dalta cu protectie  
 H Hidegvágó /védőfejjel/  
 E Cincel /con protector/



No.	mm	Box
35351	25x300	12/36
35352	25x350	10/30
35353	25x400	12/24
35355	25x500	5/20

- PL Przecinak ślusarski  
 GB Forged cold chisel  
 D Flachmeissel  
 RUS Зубило слесарное
- CZ Zámečnický sekáč  
 RO Dalta forjata pt. metal  
 H Lakatos hidegvágó  
 E Cincel de cerrajería



JUCO

No.	L (mm)	
35372	200	10
35373	250	10
35374	300	10
35376	400	10

- PL Przecinak murarski z osłoną  
 GB Forged cold chisel with protection  
 D Meissel mit handschutz  
 RUS Зубило с протектором
- CZ Zámečnický sekáč /z krytem/  
 RO Dalta forjata cu protectie  
 H Fém hidegvágó, kézvédővel  
 E Cincel de cerrajería mm con protector

PVC HANDLE  
 REKOJEŠĆ Z PCV



JUCO

No.	L (mm)	
35359	250	5
35360	300	5
35362	350	5
35364	400	5
35366	450	5
35368	500	5

- PL Łom płaski hartowany  
 GB Flat wrecking bar  
 D Nageleisen gehärtete spitze  
 RUS Лом плоский закаленный
- CZ Páčidlo ploché kalené  
 RO Ranga plata  
 H Lapos feszítővas  
 E Palanqueta



VOREL

No.	mm	
34251	450x6x35	6/24

- PL Łom  
 GB Wrecking bar  
 D Nageleisen  
 RUS Лом-гвоздодеп
- CZ Páčidlo  
 RO Ranga pt. scos cuie  
 H Szögkihúzó  
 E Palanqueta



No.	L (mm)	
34300	300	60



- PL Przebijak murarski z osłoną  
 GB Octagonal point chisel with protection  
 D Spitzmeissel mit handschutz  
 RUS Керн с протектором
- CZ Sekáč zednický s ochranným  
 RO Dorn cu protectie pt. constructii  
 H Falvélő kézvédővel  
 E Cincel de cerrajería con protector



No.	L (mm)	
35430	300	12/48



- PL Łom  
 GB Wrecking bar  
 D Nageleisen  
 RUS Лом
- CZ Páčidlo  
 RO Ranga  
 H Szögkihúzó  
 E Palanqueta



VOREL

No.	mm	
34243	500x18	10
34245	700x18	10
34247	1000x18	10



- PL Łom kwadratowy, hartowane końcówki  
 GB Square type wrecking bar  
 D Nageleisen gehärtete spitze  
 RUS Лом квадратный с закаленными концами
- CZ Páčidlo hranaté, kalené konce  
 RO Ranga patrata  
 H Négyyszög keresztmetszetű feszítővas, edzett véggel  
 E Palanqueta



VOREL

No.	mm	
34254	400x22x12	12/24
34256	600x30x16	6/12



- PL Łom  
 GB Wrecking bar  
 D Nageleisen  
 RUS Лом-гвоздодеп
- CZ Páčidlo  
 RO Ranga pt. scos cuie  
 H Szögkihúzó  
 E Palanqueta



No.	L (mm)	
34600	600	24
34750	750	6/12
34900	900	24



PL Lom sześciokątny  
GB Wrecking bar  
D Brechstange  
RUS Лом-гвоздодёр шестигранный

CZ Šestiúhľé páčidlo  
RO Ranga pt. scos cuie Profi  
H Hatszögű feszítővas  
E Palanqueta



**JUCO**

No.	L (mm)	
34204	400	5
34205	500	5
34206	600	5
34207	700	5
34208	800	5
34210	1000	5
34212	1200	5

PL Siekiera ze stali kutej  
GB Drop forged hatchet  
D Handbeil  
RUS Топор кованый

CZ Sekera ocelová kovaná  
RO Toporisca lama forjata  
H Kovácsolt acél fejseje  
E Hacha de metalo forjado



**FLO**

No.	kg	
33080	0.8	12/24

PL Siekiera  
GB Axe  
D Handbeil  
RUS Топор с фиберглассовой ручкой

CZ Sekyrka  
RO Toporisca  
H Szekerce  
E Hacha



**FLO**

No.	g	
33067	600	24
33087	800	20
33107	1000	12
33127	1250	12
33147	1400	12
33177	1600	12

PL Siekiera  
GB Axe  
D Handbeil  
RUS Топор

CZ Sekyrka  
RO Toporisca  
H Szekerce  
E Hacha

**JUCO**

No.	kg	DIN	
33024	0.4	5131	5
33026	0.6	5131	5
33028	0.8	5131	5
33030	1.0	5131	5
33032	1.25	7294	5
33035	1.50	7294	5
33038	1.80	7294	5
33039	2.0	7294	5
33040	2.50	7294	5

PL Lom budowlany  
GB Wrecking bar  
D Baubrechstange  
RUS Лом круглый

CZ Stavební páčidlo  
RO Ranga Profi  
H Szögkihűző  
E Palanqueta de obra



**JUCO**

No.	L (mm)	
34220	1000	1
34222	1200	1
34225	1500	1

PL Siekiera  
GB Axe  
D Handbeil  
RUS Топор

CZ Sekyrka  
RO Toporisca  
H Szekerce  
E Hacha



**FLO**

No.	kg	
32930	1.0	10

PL Siekiera, rączka z włókna szklanego  
GB Axe with fibreglass + PVC handle  
D Handbeil fibreglasstiel  
RUS Топор строительный с фиберглассовой ручкой

CZ Sekyrka  
RO Toporisca cu coada din fibra de sticla  
H Szekerce  
E Hacha con mango de fibra de vidrio



**VOREL**

No.	g	
33065	600	20
33085	800	20
33105	1000	12
33125	1250	6

DIN  
5131  
7294



PL Siekiera  
GB Axe  
D Handbeil  
RUS Топор

CZ Sekyrka  
RO Toporişca  
H Szekerce  
E Hacha

DIN  
5131  
7294



6

PL Siekiera z klinem  
GB Axe  
D Handbeil  
RUS Топор-колун

CZ Sekyrka  
RO Toporişca  
H Szekerce  
E Hacha



JUCO

No.	kg	Box
32924	2	5

PL Siekiero-mlot  
GB Hammer-axe for wood splitting  
D Spaltaxt  
RUS Топор-колун

CZ Sekera-kladivo  
RO Secure-ciocan  
H Szekerce-kalapács  
E Hacha martillo para partir madera



JUCO

No.	kg	Box
32925	2.5	1
32926	4.0	1

PL Siekiera kanadyjska  
GB Canadian axe  
D Handbeil „Kanadische Form“  
RUS Топор канадского типа

CZ Sekera kanadská  
RO Topor canadian  
H Hosszú nyelű, hasító fejű  
E Hacha canada

1.8  
kg



JUCO

No.	kg	Box
32927	2.1	1
32928	3.2	1

PL Trzonek do kilofa  
GB Wooden handle for pick axe  
D Stiel für Spitzhacke  
RUS Черенок для кирки

CZ Násada na krumpáč  
RO Coada tarnacop  
H Csákánynyél  
E Palo para pico

90  
cm



No.	L (mm)	for / dla	Box
32902	90	32901	10

JUCO

No.	kg	DIN	Box
33000	0.4	5131	5
33001	0.6	5131	5
33002	0.8	5131	5
33003	1.0	5131	5
33004	1.25	7294	5
33005	1.50	7294	5
33006	1.80	7294	5
33007	2.0	7294	5
33008	2.50	7294	5

PL Siekiero-mlot  
GB Hammer-axe for wood splitting  
D Spaltaxt  
RUS Топор-колун

CZ Sekera-kladivo  
RO Secure-ciocan  
H Szekerce-kalapács  
E Hacha martillo para partir madera



JUCO

No.	kg	Box
32927	2.1	1
32928	3.2	1

PL Kilof bez trzonka  
GB Pick axe  
D Spitzhacke ohne Stiel  
RUS Кирка двухсторонняя без черенка

CZ Krumpáč osazený  
RO Tarnacop  
H Ékelt csákány  
E Piqueta

2.5  
kg



VOREL

No.	kg	Box
32901	2.5	8



PL Kilof oprawiony  
 GB Pick axe  
 D Spitzhacke  
 RUS Кирка двухсторонняя с черенком

CZ Krumpáč osazený  
 RO Tămăcop cu coadă  
 H Ékelt csákány  
 E Piqueta

2.5 kg



VOREL

No.	kg	
32900	2.5	6

PL Klin do rozłupywania drewna  
 GB Wood splitter  
 D Spaltkeil  
 RUS Клин для раскалывания бревен

CZ Klin na štípání polen  
 RO Pana pt. lemn  
 H Fahasztó ék  
 E Cuña para partir madera

X



JUCO

No.	kg	
32922	2	1
32923	3	1

Memo

# 7

## Clamps & vices Ściski i imadła



## Clamps Ściski



66-67

### F-clamps & sets

Ściski stolarskie i zestawy..... 66

### Quick release clamps

Ściski szybkozaciskowe..... 66

### Spring clamps

Ściski sprężynowe..... 66

### Corner clamps

Ściski kątowe..... 66

### C-clamps

Ściski typu „C”..... 67

### Ratchet floor clamps

Pasy ściągające do paneli podłogowych..... 67

## Vices Imadła



67-68

### Baby vices

Imadła stołowe..... 67

### Bench vices

Imadła ślusarskie..... 68

### Hinged pipe vices

Imadła zaciskowe do rur..... 68

PL Ścisk stolarski  
GB F-clamp  
D Schraubzwinge  
RUS Струбцина

CZ Truhlářské upínadlo  
RO Presa lemn  
H Asztales szorító  
E Tornillo de apriete



**VOREL**

7

No.	mm	
37100	50x100	12/60
37101	50x150	12/60
37102	50x200	12/60
37103	50x250	12/60
37104	50x300	12/60
37106	80x200	10/30
37107	80x250	10/30
37108	80x300	10/20
37109	80x500	10/20
37110	120x300	10/20
37111	120x500	10
37112	120x800	10
37113	120x1000	6
37114	120x1200	6
37115	120x1500	6

PL Ścisk stolarski  
GB F-clamp  
D Schraubzwinge  
RUS Струбцина

CZ Truhlářské upínadlo  
RO Presa lemn tip „F”  
H Asztales szorító  
E Tornillo de apriete

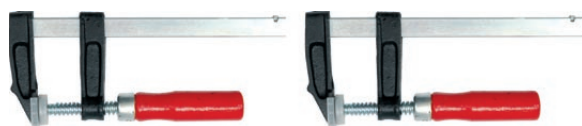

No.	mm	pcs pak/ing	
38150	50x150	2	10/30
38200	50x200	2	10/30

PL Ścisk sprężynowy  
GB Spring clamp  
D Federklemme  
RUS Струбцина пружинная

CZ Pružinové upínadlo  
RO Cleste presa pt. lemn  
H Rugós szorító  
E Pinza



No.	mm	
38500	100	24/240
38515	150	12/120
38525	200	10/100

PL Ścisk stolarski  
GB F-clamp  
D Schraubzwinge  
RUS Струбцина

CZ Truhlářské upínadlo  
RO Presa lemn  
H Asztales szorító  
E Tornillo de apriete

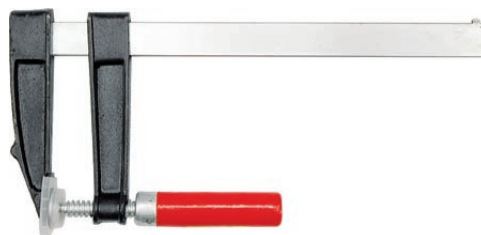

No.	mm	
37150	50x150	12/60
37200	50x200	12/60
37250	50x250	12/60
37300	50x300	12/60
37380	80x300	15/30
37400	80x500	15/30
37430	120x300	10/20
37500	120x500	10/20
37800	120x800	10
37900	120x1000	10

PL Ścisk szybkozaskowy  
GB Quick release clamp  
D Schnellklemme  
RUS Быстрозажимная струбцина

CZ Svěrka rychloupínací  
RO Clemă cu prindere rapidă  
H Gyors asztales szorító  
E Apretador rápido



**VOREL**

No.	mm	max. expand range / max. zasięg rozpięcia (mm)	max. clamping range / max. zasięg ściskania (mm)	max. jaws depth / max. głębokość szczęk (mm)	
38401	150	141-312	0-152	63	12/36
38402	200	141-355	0-203	63	6/36
38403	250	141-405	0-254	63	6/30
38404	300	141-464	0-304	63	6/30
38406	400	141-555	0-406	63	6/24
38407	450	141-617	0-457	63	6/24
38408	600	141-769	0-609	63	6/18
38409	750	141-922	0-762	63	6/12

PL Ścisk stolarski kątowy  
GB Corner clamp  
D Gehrungszwinge  
RUS Струбцина угловая

CZ Truhlářské upínadlo úhlové  
RO Cleste presa colt  
H Asztales szorító, sarok  
E Tornillo de angulo



No.	mm	
38750	75	10/100

- PL Ścisik stolarski kątowy  
GB Corner clamp  
D Gehrungszwinge  
RUS Струбцина угловая
- CZ Truhlářské upínadlo úhlové  
RO Cleste presa colt  
H Asztalos szorító, sarok  
E Tornillo de angulo

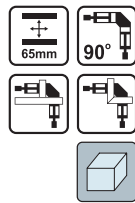

VOREL

No.	mm	
38751	65	6/12

- PL Ścisiki modelarskie  
GB C-clamp set  
D Mini-schraubzwingensatz  
RUS Набор струбцин G-типа
- CZ Modelářské upínadlo  
RO Presa lemni tip „C” set  
H Modellező szorítók  
E Tornillos tipo „C”



No.	mm	
38830	25; 50; 75	12/48

- PL Imadło stolowe  
GB Baby vice - fixed base  
D Bankschraubstock  
RUS Тиски настольные неповоротные
- CZ Stolní svěrák  
RO Menghină de masă  
H Satu, asztali  
E Tornillo de apriete

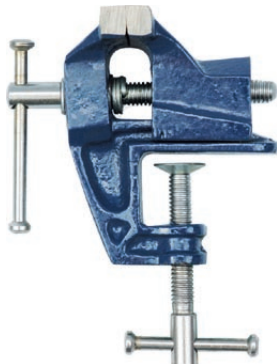

No.	mm	
36000	25	15/60
36004	40	12/48
36005	50	18/36
36006	60	12/24
36008	70	10/20

- PL Ścisik typu „C”  
GB C clamp  
D C-schraubzwinige  
RUS Струбцина тип „G”

- CZ Sverka tvaru „C”  
RO Menghină tip „C”  
H Pillanatszorító  
E Tornillo tipo „C”

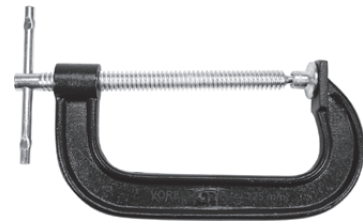

VOREL

No.	size / rozmiar (mm)	force pressure / sila nacisku (kg)	
38430	50	140	50
38431	75	190	30
38432	100	270	30
38433	125	320	20
38434	150	360	18
38435	200	390	10
38436	250	420	6

- PL Pas ściągający do paneli podłogowych  
GB Ratchet floor clamp  
D Spanngurt für Laminatpannele / mit Hacken und Knarre/  
RUS Ремень для стяжки напольных панелей
- CZ Stahovací pás na podlahní panele  
RO Curea elastică strâns plăci parchet  
H Padlópanelhez rögzítő pánt  
E Cinta tirante para placas de suelo



No.	tape / taşma L (m)	
82355	5	10/20

- PL Imadło stolowe obrotowe  
GB Baby vice - swivel base  
D Bankschraubstock drehbar  
RUS Тиски настольные поворотные
- CZ Stolní svěrák otáčivý  
RO Menghină rotativă de masă  
H Satu, asztali, forgó  
E Tornillo de apriete giratorio



No.	mm	
36014	40	12/24
36015	50	10/20
36016	60	9/18
36018	75	6/12

PL Imadło stolowe  
GB Baby vice - fixed base  
D Bankschraubstock  
RUS Тиски настольные поворотные

CZ Stólní svěrák  
RO Menghină de masă  
H Satu, asztați  
E Tornillo de apriete

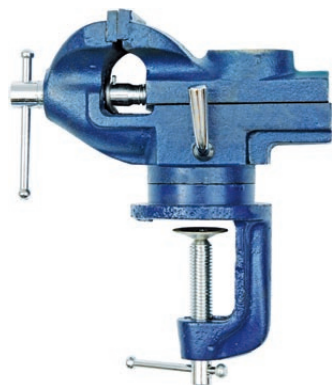

7

**VOREL**

No.	mm	
36650	65	10

PL Imadło ślusarskie obrotowe  
GB Bench vice - swivel base  
D Schloserschraubstock drehbar  
RUS Тиски слесарные поворотные

CZ Zámečnický svěrák otáčivé  
RO Menghină de lăcătușerie rotativă  
H Satu, lakatos forgó  
E Tornillo de apriete giratorio

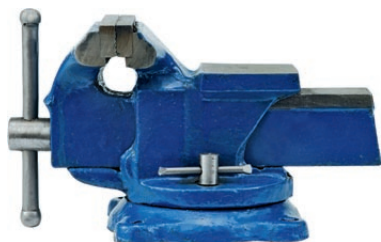

**VOREL**

No.	mm	
36037	100	1
36038	125	1
36039	150	1

PL Imadło ślusarskie  
GB Bench vice - fixed base  
D Schloserschraubstock  
RUS Тиски слесарные с наковальной

CZ Zámečnický svěrák  
RO Menghină de lăcătușerie  
H Satu, lakatos  
E Tornillo de apriete

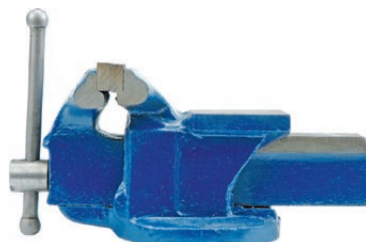

**VOREL**

No.	mm	
36032	100	1
36033	125	1
36034	150	1

PL Imadło zaciskowe do rur  
GB Hinged pipe vice  
D Rohrschraubstock  
RUS Тиски для труб

CZ Upínací svěrák na trubky  
RO Menghină pt. tevi  
H Satu, csőszorító  
E Tornillo de apriete para tubos

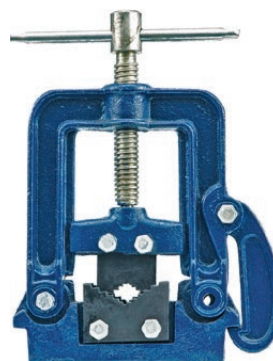

**VOREL**

No.	mm	
36570	13-50	6

Memo	
------	--

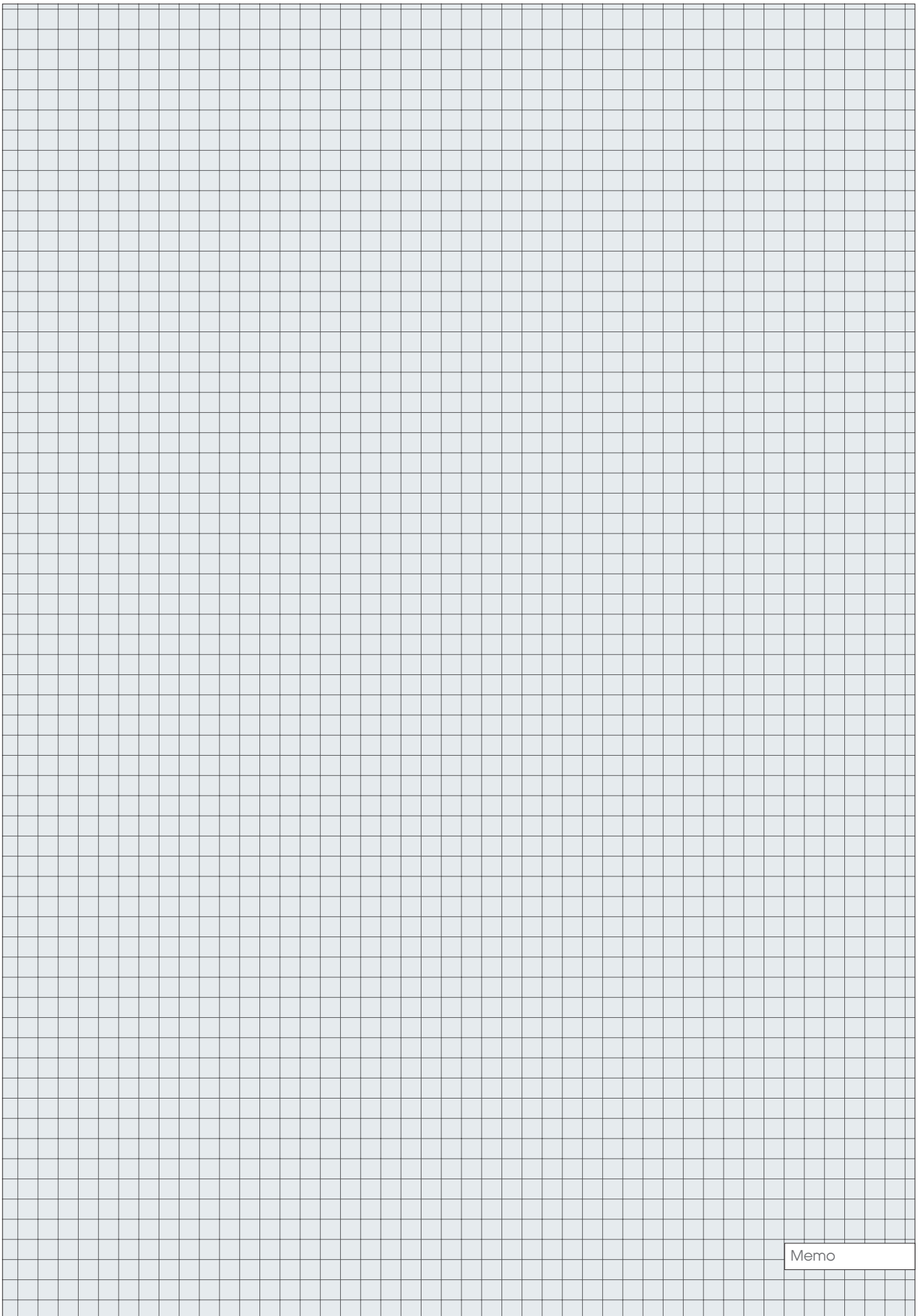

Memo

# 8

## Cutting tools Narzędzia tnące





## Drill bits Wiertła



73-79

### Twist drill bits HSS & sets

Wiertła do metalu HSS i zestawy..... 73

### Twist drill bits HSS-G & sets

Wiertła do metalu HSS-G i zestawy..... 74

### Masonry drill bits & sets

Wiertła do betonu i zestawy..... 74

### Masonry drill bits with cylindrical shank

Wiertła do betonu z uchwytem cylindrycznym..... 74

### Wood drill bits

Wiertła do drewna..... 75

### SDS Masonry drill bits & sets

Wiertła do betonu SDS i zestawy..... 76

### SDS Chisels

Przecinaki i dłuta SDS..... 76

### Hollow drill sets

Wiertła koronowe do betonu..... 78

### Hole saw kits

Zestawy otwornic..... 78

### Tungsten carbide hole saws

Otwornice z węglikiem wolframu..... 79

### Tile and glass drill bits

Wiertła do glazury i szkła..... 79

## Taps & dies

### Narzędzia do gwintowania



79-81

### Hand taps CZ TOOLS

Gwintowniki CZ TOOLS..... 79

### Circular dies CZ TOOLS

Narzynki CZ TOOLS..... 80

### Machine taps CZ TOOLS

Gwintowniki maszynowe CZ TOOLS..... 80

### Tap & die sets CZ TOOLS

Zestawy gwintowników i narzynek CZ TOOLS..... 80

### Tap wrenches & die holders

Pokręta do gwintowników i narzynek..... 80

### Tap & die sets

Zestawy gwintowników i narzynek..... 81

### Screw extractor sets

Wykrętaki do zerwanych śrub..... 81

## Router bit sets

### Zestawy frezów do drewna



81

## Diamond tools

### Narzędzia diamentowe



81-82

### Diamond blades for cutting construction materials

Tarcze diamentowe do cięcia materiałów budowlanych..... 81

### Diamond rod saws

Brzeszczoty diamentowe..... 82

## Tungsten carbide tipped tools

### Narzędzia z ostrzem z węglika wolframu



83

### Tungsten carbide saws for wood

Tarcze z węglikiem do drewna..... 83

### Tungsten carbide saws for aluminium

Tarcze z węglikiem do aluminium..... 83

## Cutting & grinding discs

### Tarcze do cięcia i szlifowania



83-84

### Metal cutting discs

Tarcze do cięcia metalu..... 83

### Metal grinding discs

Tarcze do szlifowania metalu..... 84

### Stone cutting discs

Tarcze do cięcia kamienia..... 84

### Stone grinding discs

Tarcze do szlifowania kamienia..... 84

## Flap discs

### Ściernice listkowe talerzowe



85

## Chain discs

### Tarcze łańcuchowe



85

## Grinding discs

### Tarcze do szlifierek stołowych



85

## Shears

### Nożyce



85-87

### Tin snips

Nożyce do blachy..... 85

### Bolt cutters

Nożyce do prętów..... 87

## Saws & blades

### Piły i brzeszczoty



87-92

### Hand saws

Piły do drewna..... 87

### Bow saws

Piły kabłąkowe..... 88

### Bow saw blades

Brzeszczoty do pił kabłąkowych..... 88

### Compass saws

Piły otwornice..... 88

### Saws for gas concrete

Piły do gazobetonu..... 88

### Hacksaw frames

Piły do metalu..... 89

### Cross cut saws

Piły poprzeczne..... 89

### Mitre saws

Piły kątowe..... 90

### Mitre boxes

Skrzynki uciosowe..... 90

<b>Blades</b>	
Brzeszczoty.....	91
<b>Jig saw blades</b>	
Brzeszczoty do wyrzynarek.....	92

## Brushes, knives & files

### Szczotki, noże i pilniki

93-103



<b>Wire brushes</b>	
Szczotki druciane.....	93
<b>Cup brushes</b>	
Szczotki tarczowe.....	93
<b>Rubber discs</b>	
Tarcze gumowe do elektronarzędzi.....	95
<b>Pocket knives</b>	
Noże składane.....	97
<b>Window scrapers</b>	
Skrobaki do szyb.....	99
<b>Glass cutters</b>	
Nożyki do cięcia szkła.....	99
<b>Scrapers</b>	
Cykliny.....	100
<b>Wood carving knife sets</b>	
Zestawy nożyków precyzyjnych.....	100
<b>Scissors</b>	
Nożyczki.....	100
<b>Pliers for plastic snap fasteners</b>	
Praski do zaciskania nap.....	100
<b>Punch sets</b>	
Komplety przebijańców do skóry.....	100
<b>Wood planes</b>	
Strugi.....	101
<b>Steel files</b>	
Pilniki do metalu.....	101
<b>Rasps</b>	
Tarniki do drewna.....	102

## Abrasive products

### Artykuły ściernie

103-106

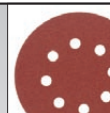

<b>Sharpening stones</b>	
Osetki.....	103
<b>Waterproof sand papers</b>	
Papiery ściernie wodoodporne.....	103
<b>Abrasive clothes</b>	
Płótna ściernie.....	103
<b>Abrasive meshes</b>	
Siatki ściernie.....	104
<b>No end abrasive bands</b>	
Taśmy ściernie bezkońcowe.....	104
<b>Abrasive sponges</b>	
Kostki ściernie.....	104
<b>Abrasive sheets and discs</b>	
Arkusze i krążki ściernie.....	105
<b>Sanding blocks</b>	
Bloki ściernie.....	105

- PL Wiertło do metalu
- GB Twist drill bit
- D Spiralbohrer
- RUS Сверло по металлу
- CZ Vrták na kov
- RO Burghiu pt. metal
- H Fúrószár fémhez
- E Broca para metalo



No.	Ø (mm)	pcs packing	box
20100	1.0	10	200/10000
20150	1.5	10	200/8000
20200	2.0	10	200/8000
20250	2.5	10	200/4000
20280	2.8	10	200/4000
20300	3.0	10	200/4000
20320	3.2	10	200/4000
20350	3.5	10	100/4000
20400	4.0	10	100/4000
20420	4.2	10	100/2500
20450	4.5	10	100/2500
20500	5.0	10	100/2500
20550	5.5	10	100/2000
20600	6.0	10	50/1200
20650	6.5	10	50/1200
20700	7.0	10	50/1200
20800	8.0	5	50/600
20850	8.5	5	50/600
20900	9.0	5	50/600
21000	10.0	5	50/250
21100	11.0	5	50/250
21200	12.0	5	50/250
21250	12.5	5	50/250
21300	13.0	5	50/250
21400	14.0	5	50/200
21600	16.0	5	10/100

- PL Komplet wiertel do metalu
- GB Twist drill set
- D Spiralbohrersatz
- RUS Набор сверл по металлу
- CZ Vrtáky na kov
- RO Burghie pt. metal
- H Fúrószár fémhez
- E Broca para metalo



No.	Ø (mm)	pcs	box
22330	1.0; 1.5; 2.0; 2.5; 3.0; 3.5; 4.0; 4.5; 5.0; 5.5; 6.0; 6.5; 7.0; 7.5; 8.0; 8.5; 9.0; 9.5; 10.0	19	30
22340	1.0; 1.5; 2.0; 2.5; 3.0; 3.5; 4.0; 4.5; 5.0; 5.5; 6.0; 6.5; 7.0; 7.5; 8.0; 8.5; 9.0; 9.5; 10.0; 10.5; 11.0; 11.5; 12.0; 12.5; 13.0	25	20

- PL Komplet wiertel do metalu
- GB Twist drill set
- D Spiralbohrersatz
- RUS Набор сверл по металлу
- CZ Vrtáky na kov
- RO Burghie pt. metal
- H Fúrószár fémhez
- E Broca para metalo



No.	Ø (mm)	pcs	box
22130	1.5; 2.0; 2.5; 3.0; 3.2; 3.5; 4.0; 4.5; 4.8; 5.0; 5.5; 6.0; 6.5	13	25/100
22180	2.0; 2.5; 3.0; 3.5; 4.0; 4.5; 5.0; 5.5; 6.0; 6.5; 7.0; 7.5; 8.0	13	25/50

- PL Komplet wiertel do metalu
- GB Twist drill set
- D Spiralbohrersatz
- RUS Набор сверл по металлу
- CZ Vrtáky na kov
- RO Burghie pt. metal
- H Fúrószár fémhez
- E Broca para metalo



No.	Ø (mm)	pcs	box
22190	1.0; 1.5; 2.0; 2.5; 3.0; 3.5; 4.0; 4.5; 5.0; 5.5; 6.0; 6.5; 7.0; 7.5; 8.0; 8.5; 9.0; 9.5; 10.0	19	30
22250	1.0; 1.5; 2.0; 2.5; 3.0; 3.5; 4.0; 4.5; 5.0; 5.5; 6.0; 6.5; 7.0; 7.5; 8.0; 8.5; 9.0; 9.5; 10.0; 10.5; 11.0; 11.5; 12.0; 12.5; 13.0	25	20

- PL Komplet wiertel do metalu
- GB Twist drill set
- D Spiralbohrersatz
- RUS Набор сверл по металлу
- CZ Vrtáky na kov
- RO Burghie pt. metal
- H Fúrószár fémhez
- E Broca para metalo



No.	Ø (mm)	pcs	box
22300	1.5; 2.0; 2.5; 3.0; 3.2; 3.5; 4.0; 4.5; 4.8; 5.0; 5.5; 6.0; 6.5	13	25/100
22310	2.0; 2.5; 3.0; 3.5; 4.0; 4.5; 5.0; 5.5; 6.0; 6.5; 7.0; 7.5; 8.0	13	25/50

PL Wiertło do metalu HSS  
GB HSS twist drill bit  
D Spiralbohrer HSS  
RUS Свёрло по металлу HSS

CZ Vrták na kov HSS  
RO Burghiu pt. metal HSS  
H Fúrószár fémhez HSS  
E Broca para metalu HSS



PL Komplet wiertel do metalu  
GB Twist drill set  
D Spiralbohrersatz  
RUS Набор свёрл по металлу  
CZ Vrtáky na kov  
RO Burghie pt. metal  
H Fúrószár fémhez  
E Broca para metalu



**STHOR**

No.	Ø (mm)	pcs	Box
21998	2.0; 2.5; 3.0; 3.5; 4.0; 4.5; 5.0; 5.5; 6.0; 6.5; 7.0; 7.5; 8.0	13	10/50

PL Komplet wiertel do metalu  
GB Twist drill set  
D Spiralbohrersatz  
RUS Набор свёрл по металлу  
CZ Vrtáky na kov  
RO Burghie pt. metal  
H Fúrószár fémhez  
E Broca para metalu



**STHOR**

No.	Ø (mm)	pcs	Box
21999	1.0; 1.5; 2.0; 2.5; 3.0; 3.5; 4.0; 4.5; 5.0; 5.5; 6.0; 6.5; 7.0; 7.5; 8.0; 8.5; 9.0; 9.5; 10.0	19	5/30

PL Wiertło do betonu  
GB Masonry drill bit  
D Betonbohrer  
RUS Свёрло по бетону

CZ Vrták na beton  
RO Burghiu pt. beton  
H Fúrószár betonhoz  
E Broca para hormigon



**STHOR**

No.	Ø (mm)	L (mm)	Box
23311	4	75	200/1600
23312	5	85	200/1600
23313	6	100	200/1000
23324	6	400	100/300
23314	7	100	200/1000
23315	8	120	100/500
23325	8	400	50/200
23316	10	120	100/500
23326	10	400	50/100
23317	12	150	50/200
23327	12	400	50/100
23318	14	150	50/150
23328	14	400	50/100
23319	16	150	50/150
23329	16	400	50/100
23320	18	150	50/150
23321	20	150	25/100

**STHOR**

No.	Ø (mm)	pcs packing	Box
21900	1.0	10	20/1000
21905	1.5	10	20/1000
21910	2.0	10	20/800
21915	2.5	10	20/800
21919	3.0	10	20/500
21921	3.2	10	20/400
21924	3.5	10	10/400
21927	4.0	10	10/400
21929	4.2	10	10/250
21932	4.5	10	10/250
21934	4.8	10	10/250
21936	5.0	10	10/250
21941	5.5	10	10/200
21944	6.0	10	10/120
21948	6.5	10	5/120
21950	7.0	5	10/120
21951	7.5	5	10/120
21952	8.0	5	10/120
21955	8.5	5	10/120
21956	9.0	5	10/120
21958	10.0	5	10/50
21961	11.0	5	10/50
21963	12.0	5	10/50
21966	13.0	3	16/48

PL Komplet wiertel do metalu  
GB Twist drill set  
D Spiralbohrersatz  
RUS Набор свёрл по металлу  
CZ Vrtáky na kov  
RO Burghie pt. metal  
H Fúrószár fémhez  
E Broca para metalu



**STHOR**

No.	Ø (mm)	pcs	Box
21650	4, 5, 6, 8, 10	5	30/60

- PL Wiertła do betonu
- GB Masonry drill set
- D Betonbohrer
- RUS Набор сверл по бетону
- CZ Souprava vrtáků do betonu
- RO Set de burghie pt. beton
- H Fúrószárkészlet betonhoz
- E Brocas para hormigon



5  
PCS



**STHOR**

No.	mm	pcs	
23331	4; 5; 6; 8; 10	5	50/200

- PL Wiertła do drewna
- GB Wood drill set
- D Holzbohrersatz
- RUS Набор сверл по дереву

- CZ Vrtáky na dřevo
- RO Burghie pt. lemn
- H Fúró fához
- E Brocas para maderaz

8  
PCS



**STHOR**

No.	Ø (mm)	pcs	
22380	3; 4; 5; 6; 7; 8; 9; 10	8	20/100

- PL Wiertła do drewna
- GB Wood drill set
- D Holzbohrersatz
- RUS Набор сверл по дереву

- CZ Vrtáky na dřevo
- RO Burghie pt. lemn
- H Fúró fához
- E Brocas para maderaz

6  
PCS



**STHOR**

No.	Ø (mm)	L (mm)	pcs	
22460	6; 8; 10; 12; 13; 14	300	6	25

- PL Wiertła do drewna
- GB Wood drill set
- D Holzbohrersatz
- RUS Набор сверл по дереву

- CZ Vrtáky na dřevo
- RO Burghie pt. lemn
- H Fúró fához
- E Brocas para maderaz

6  
PCS

460  
mm



**STHOR**

No.	Ø (mm)	L (mm)	pcs	
22466	10; 12; 14; 16; 18; 20	460	6	10

- PL Wiertła do drewna
- GB Wood drill set
- D Holzbohrersatz
- RUS Набор сверл по дереву

- CZ Vrtáky na dřevo
- RO Burghie pt. lemn
- H Fúró fához
- E Brocas para maderaz

5  
PCS



No.	Ø (mm)	pcs	
22350	4; 5; 6; 8; 10	5	25/200

- PL Wiertła do drewna
- GB Wood drill set
- D Holzbohrersatz
- RUS Набор сверл по дереву

- CZ Vrtáky na dřevo
- RO Burghie pt. lemn
- H Fúró fához
- E Brocas para maderaz

8  
PCS



**STHOR**

No.	Ø (mm)	pcs	
22381	3; 4; 5; 6; 7; 8; 9; 10	8	10/80

- PL Wiertła do drewna
- GB Wood drill set
- D Holzbohrersatz
- RUS Набор сверл по дереву

- CZ Vrtáky na dřevo
- RO Burghie pt. lemn
- H Fúró fához
- E Brocas para maderaz

6  
PCS

230  
mm



**STHOR**

No.	Ø (mm)	L (mm)	pcs	
22465	10; 12; 14; 16; 18; 20	230	6	10

- PL Wiertła do drewna, łopatkowe
- GB Flat wood bits
- D Holz-Flachfräsbohrersatz
- RUS Набор сверл по дереву

- CZ Vrtáky na dřevo
- RO Burghie pt. lemn
- H Fúró fához
- E Brocas para maderaz

6  
PCS



No.	Ø (mm)	pcs	
22500	10; 12; 16; 18; 20; 25	6	10/100

PL Wiertło do betonu  
GB Masonry drill bit  
D Betonbohrer  
RUS Бур по бетону

CZ Vrták na beton  
RO Burghiu pt. beton  
H Fúrószár betonhoz  
E Broca para hormigon



**STHOR**

No.	Ø (mm)	L (mm)	☐
23620	5	110	10/500
23640	6	110	10/500
23650	6	160	10/500
23660	6	210	10/300
23670	8	110	10/500
23680	8	160	10/400
23690	8	210	10/250
23692	8	300	10/200
23693	8	460	10/100
23694	8	600	10/100
23710	10	160	10/300
23720	10	210	10/250
23722	10	300	10/150
23723	10	460	10/100
23724	10	600	10/100
23730	12	160	10/300
23740	12	460	10/100
23750	12	266	10/150
23752	12	600	10/60
23800	14	166	10/200
23820	14	460	10/80
23830	14	266	10/150
23832	14	600	10/50
23840	16	200	10/160
23850	16	300	8/96
23860	16	460	8/48
23862	16	600	8/48
23880	18	300	8/72
23882	18	460	6/48
23883	18	600	6/48
23920	20	300	5/50
23930	20	450	5/50
23932	20	600	5/30
23960	22	460	5/25
23962	22	600	5/25
23980	25	300	5/50
23982	25	600	5/15
23990	25	460	5/25
23992	28	600	2/10
23999	30	600	2/10

PL Komplet wiertel do betonu  
GB Masonry drill set  
D Betonbohrersatz  
RUS Наб. буров по бетону  
CZ Souprava vrtáků do betonu  
RO Set de burghie pt. beton  
H Fúrószárkészlet betonhoz  
E Juego de brocas



**STHOR**

No.	Ø mm	pcs	☐
23988	5; 6; 8; 10; 12x160	5	15/60

PL Wiertło do betonu  
GB Masonry drill bit  
D Betonbohrer  
RUS Бур по бетону

CZ Vrták na beton  
RO Burghiu pt. beton  
H Fúrószár betonhoz  
E Broca para hormigon



**STHOR**

No.	Ø (mm)	L (mm)	☐
23371	16	300	10/50
23390	16	600	5/30
23411	16	900	4/20
23372	18	300	10/50
23391	18	600	5/30
23412	18	900	4/20
23373	20	300	8/40
23392	20	600	4/20
23413	20	900	2/10
23374	22	300	6/30
23393	22	600	4/20
23414	22	900	2/10
23375	24	300	6/30
23394	24	600	4/20
23415	24	900	2/10
23376	25	300	6/30
23395	25	600	4/20
23416	25	900	2/10
23377	26	300	6/30
23396	26	600	2/10
23417	26	900	2/10
23378	28	300	4/20
23397	28	600	2/10
23418	28	900	5
23379	30	300	4/20
23398	30	600	2/10
23419	30	900	5
23380	32	300	4/20
23399	32	600	2/10
23420	32	900	5
23381	35	300	4/20
23400	35	600	2/10
23421	35	900	5
23382	37	300	4/20
23401	37	600	2/10
23422	37	900	5
23383	38	300	4/20
23402	38	600	2/10
23423	38	900	5
23403	40	600	5
23424	40	900	5

PL Grot SDS Plus  
GB Point chisel  
D Spitzmeißel  
RUS Зубило пиковое

CZ Špičák  
RO Dorn  
H Hegyes véső  
E Cincel punta



**STHOR**

No.	Ø (mm)	L (mm)	☐
23590	14	250	25/50

PL Grot SDS Max  
GB Point chisel  
D Spitzmeißel  
RUS Зубило пиковое

CZ Špičák  
RO Dom  
H Hegyes véső  
E Cincel punta



**STHOR**

No.	Ø (mm)	L (mm)	Box
23601	18	280	20/40
23602	18	400	15/30

PL Dłuto wąskie SDS Max  
GB Flat chisel  
D Flachmeißel  
RUS Зубило узкое

CZ Sekáč  
RO Dalta spatulată  
H Lapos véső  
E Cincel plano



**STHOR**

No.	Ø (mm)	L (mm)	Box
23603	25x18	280	20/40
23604	25x18	400	10/20

PL Dłuto szerokie SDS Max  
GB Spade chisel  
D Spatmeißel  
RUS Зубило плоское широкое

CZ Sekáč plochý  
RO Dalta  
H Széles véső  
E Cincel pala



**STHOR**

No.	Ø (mm)	L (mm)	Box
23605	40x18	280	20/40
23606	50x18	400	10/20

PL Bruzdownik SDS Max  
GB Groove chisel  
D Nutenmeißel  
RUS Зубило-штробер

CZ Sekáč drážkovací  
RO Dalta canal  
H Horonyvėső  
E Cincel acanalado



**STHOR**

No.	Ø (mm)	L (mm)	Box
23608	25x18	400	10/20

PL Dłuto wąskie SDS Plus  
GB Flat chisel  
D Flachmeißel  
RUS Зубило узкое

CZ Sekáč  
RO Dalta spatulată  
H Lapos vėső  
E Cincel plano



**STHOR**

No.	Ø (mm)	L (mm)	Box
23591	20x14	250	25/50

PL Dłuto szerokie SDS Plus  
GB Spade chisel  
D Spatmeißel  
RUS Зубило плоское широкое

CZ Sekáč plochý  
RO Dalta  
H Széles vėső  
E Cincel pala



**STHOR**

No.	Ø (mm)	L (mm)	Box
23592	40x14	250	25/50

PL Bruzdownik SDS Plus  
GB Groove chisel  
D Nutenmeißel  
RUS Зубило-штробер

CZ Sekáč drážkovací  
RO Dalta canal  
H Horonyvėső  
E Cincel acanalado



**STHOR**

No.	Ø (mm)	L (mm)	Box
23593	22x14	250	25/50

PL Komplet wiertel i przecinaków do betonu  
GB Hammer drill & chisel set  
D Bohrer und Meißel Satz  
RUS Набор буров и зубил

CZ Souprava vrtáků + sekáče  
RO Set de burghie + dalte tăietor  
H Fűrészárszlet + hűgévágó  
E Juego de cinceles y brocas

12  
PCS

SDS  
PLUS

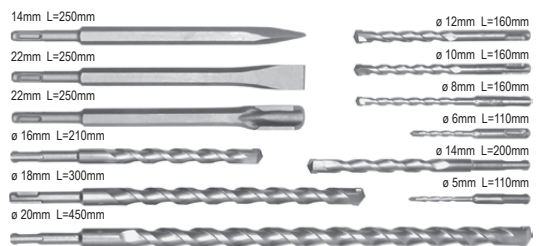

**VOREL**

No.	pcs	Box
23585	12	8

- PL Komplet wiertel i przecinaków do betonu  
 GB Hammer drill & chisel set  
 D Bohrer und Meißel Satz  
 RUS Набор буров и зубил  
 CZ Souprava vrtáků + sekáče  
 RO Set de burghie + dalte tăietor  
 H Fúrászárkészlet + hidegvágó  
 E Juego de cinceles y brocas

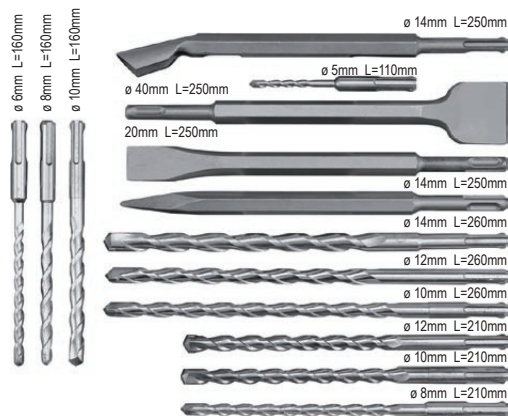

14  
PCS  
SDS  
PLUS



No.	pcs	☐
23586	14	6

- PL Wiertło koronowe do muru  
 GB Hollow drill set  
 D Bohrkronen  
 RUS Коронка по бетону  
 CZ Korunový vrták na zed' - pouzdro šestiúhelník  
 RO Burghiu cu coroană pt. beton - mandrină hexagonală  
 H Koronafúró falhoz - hatszögletű szárral  
 E Broca widia para muro



- PL Wiertło koronowe do muru  
 GB Hollow drill set  
 D Bohrkronen  
 RUS Коронка по бетону  
 CZ Korunový vrták na zed' - pouzdro šestiúhelník  
 RO Burghiu cu coroană pt. beton - mandrină hexagonală  
 H Koronafúró falhoz - hatszögletű szárral  
 E Broca widia para muro



No.	Ø (mm)	☐
03240	65	24
03241	80	20

- PL Wycinarka do płyt gipsowych  
 GB Drywall circle cutter  
 D Schnitzzirkel für Gipsplatten  
 RUS Резак круговой по гипскартону
- CZ Vystřihováčka pro sádrové desky  
 RO Tăietoare pt. plăci de ghips  
 H Gipszfalkvágó  
 E Compas cortador para planchas de escayola



No.	Ø (mm)	☐
03990	30-400	12/48

- PL Wycinarka otworów do drewna  
 GB Hole saw set  
 D Lochsägensatz  
 RUS Пилы кольцевые по дереву в наборе  
 CZ Vytínač otvorů  
 RO Tăietor (ferăstrău rotund) pt. orificii  
 H Lyukasztó  
 E Sierra de corona para madera

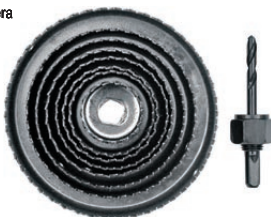

No.	Ø (mm)	pcs	☐
22572	38-127	9	6/24



No.	Ø (mm)	☐
03245	65	24
03246	80	20

- PL Wycinarka otworów do drewna  
 GB Hole saw set  
 D Lochsägensatz  
 RUS Пилы кольцевые по дереву в наборе
- CZ Vytínač otvorů  
 RO Tăietor (ferăstrău rotund) pt. orificii  
 H Lyukasztó  
 E Sierra de corona para madera

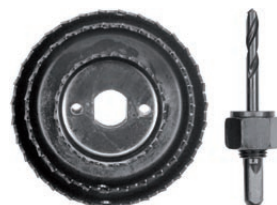

No.	Ø (mm)	pcs	☐
22565	51; 76; 89	4	12/48

- PL Zestaw wycinarek do otworów w drewnie  
 GB Hole saw set  
 D Lochsägensatz  
 RUS Пилы кольцевые по дереву в наборе
- CZ Vytínač otvorů  
 RO Tăietor (ferăstrău rotund) pt. orificii  
 H Lyukasztó  
 E Juego de sierras de corona



No.	Ø (mm)	pcs	☐
22570	19-64	11	12/36



- PL Zestaw wycinarek do otworów w drewnie  
 GB Hole saw set  
 D Lochsägensatz  
 RUS Пилы кольцевые по дереву в наборе
- CZ Vytínač otvorů  
 RO Tăietor (ferăstrău rotund) pt. orificii  
 H Lyukasztó  
 E Juego de sierras de corona

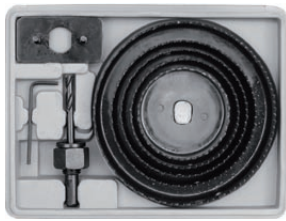

No.	Ø (mm)	pcs	Box
22571	64-127	8	6/24

- PL Wyrzynarka do drewna  
 GB Hole saw for wood  
 D Lochsägensatz  
 RUS Пилы кольцевые по дереву

- CZ Vyřezávací pila  
 RO Set freze decupat lemn  
 H Szúrófűrész  
 E Sierra de corona

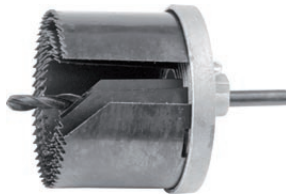
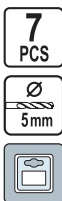

No.	Ø (mm)	L (mm)	Box
28710	26; 32; 38; 45; 50; 56; 63	17	10/100
28720	26; 32; 38; 45; 50; 56; 63	45	10/80

- PL Otwornica do PCV  
 GB PVC Hole cutter  
 D PVC Lochmesser  
 RUS Сверло по дереву, гипсокартону, ПВХ
- CZ Otvornice na PVC  
 RO Dispozitiv decupat PVC  
 H Lyukasztó PVC  
 E Cortador de agujeros de PVC

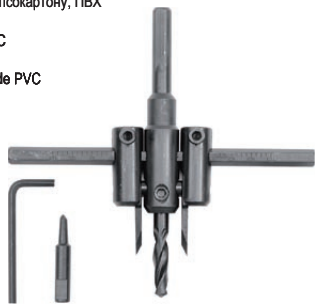

No.	Ø (mm)	pcs	Box
28733	30-120	3	6/60

- PL Wiertło do szkła i glazury  
 GB Tile and glass drill  
 D Glass- und Fliesbohrer  
 RUS Сверло по плитке и стеклу

- CZ Vrták do skla a glazury  
 RO Burghiu pt. sticlă și glazură  
 H Üveg- és csempéfúró  
 E Broca para cristal y azulejos



No.	L (mm)	Box
05540	4	50/100
05560	6	50/100
05580	8	50/100
05600	10	50/100

- PL Wyrzynarka do drewna, hartowane zęby  
 GB Hole saw for wood with hardened teeth  
 D Lochsägensatz  
 RUS Пилы кольцевые по дереву закалённые зубья

- CZ Vyřezávací pila kalená  
 RO Set freze circulare cu dinti caliti  
 H Szúrófűrész edzett  
 E Sierra de corona curtido



No.	Ø (mm)	L (mm)	Box
28680	26; 32; 38; 45; 50; 56; 63	17	10/100
28690	26; 32; 38; 45; 50; 56; 63	45	10/80

- PL Zestaw wycinarek do otworów  
 GB Hole saw set  
 D Lochsägensatz  
 RUS Пилы кольцевые по дереву
- CZ Vytínač otvorů  
 RO Set freze  
 H Lyukasztó  
 E Cortador de agujeros



No.	Ø (mm)	pcs	Box
28725	60; 67; 74; 81; 95	8	6/24

- PL Zestaw wycinarek wolframowych  
 GB Tungsten carbide coated hole saw set  
 D Lochbohrersatz  
 RUS Коронки вольфрамовые
- CZ Sada děrovacích vrtáků pro keramiku  
 RO Set freze + maner  
 H Körkivógó készlet wolfram borítással  
 E Juego de punzones de wolframio



No.	Ø (mm)	Box
03300	33; 53; 67; 73	20
03301	33; 53; 67; 83	20

- PL Gwintowniki  
 GB Hand taps  
 D Handgewindebohrer  
 RUS Метчик

- CZ Závitníky  
 RO Tarozii  
 H Menetfúró  
 E Machos de rosca



No.	M	pcs/packing	Box
24300	M3	3	25/100
24310	M4	3	25/100
24320	M5	3	25/100
24330	M6	3	25/100
24340	M7	3	25/100
24350	M8	3	25/100



PL Gwintowniki  
GB Hand taps  
D Handgewindebohrer  
RUS Метчик

CZ Závitníky  
RO Tarozii  
H Menetfűró  
E Machos de roscar



No.	M	pcs packing	
24370	M10	3	25/100
24390	M12	3	25/100
24410	M14	3	20
24430	M16	3	20
24450	M18	3	20
24470	M20	3	20

PL Gwintownik maszynowy  
GB Machine taps  
D Maschinengewindebohrer  
RUS Метчик машинный

CZ Strojní závitník  
RO Tarod de maşină  
H Gépi menetfűró  
E Macho mecanico



No.	Ø M	
24960	M3	25/100
24961	M4	25/100
24962	M5	25/100
24963	M6	25/100
24964	M8	25/100
24965	M10	25/100
24966	M12	25/100

PL Komplet gwintowników i narzynek  
GB Tap and die set  
D Gewindegewindeschneidwerkzeugsatz  
RUS Набор плашек и метчиков

CZ Souprava závitníků a kruhových závitových čelistí  
RO Set de tarozii și filiere  
H Menetfűró és menetvágó készlet  
E Juego de machos de roscar y cojinetes



No.	Ø M	pcs	
24900	M3; M4; M5; M6; M8; M10; M12	32	5

PL Komplet narzynek  
GB Die set  
D Aussengewindeschneidesatz  
RUS Набор плашек

CZ Souprava kruhových závitových čelistí  
RO Set de filiere  
H Menetvágó készlet  
E Juego de cojinetes



No.	Ø M	pcs	
24950	M3; M4; M5; M6; M7; M8; M10; M12	9	60

PL Narzynka  
GB Circular die  
D Schneideisen  
RUS Плашка

CZ Kruhová závitová čelist  
RO Filieră  
H Menetvágó  
E Cojinetes de roscar



No.	Ø M	
24500	M3	25/100
24510	M4	25/100
24520	M5	25/100
24530	M6	25/100
24540	M7	25/100
24550	M8	25/100
24570	M10	25/100
24590	M12	25/100
24610	M14	25/100
24630	M16	15/60
24650	M18	15/30
24670	M20	15/60

PL Komplet gwintowników  
GB Hand tap set  
D Innengewindebohrersatz  
RUS Набор метчиков

CZ Souprava závitníků  
RO Set de tarozii  
H Menetfűró készlet  
E Juego de machos de roscar



No.	Ø M	pcs	
24940	M3; M4; M5; M6; M7; M8; M10; M12	25	60

PL Grzechotka do gwintownika  
GB Ratchet tap wrench  
D Gewindebohrerratsche  
RUS Вороток для метчиков с трещоткой

CZ Řečtačka na závitník  
RO Cheie cu clichet pt. tarod  
H Racsnis hajtószer menetfűróhoz  
E Carraca para macho de roscar



No.	Ø M	
24700	M3-M8	25/100
24710	M5-M12	25/100

- PL Pokrętko do gwintownika  
GB Tap wrench  
D Windeisen  
RUS Вороток для метчиков
- CZ Ovládací kolečko na závitník  
RO Cheie (măner) pt. tarod  
H Hajtószár menetfúróhoz  
E Llave giramachos



No.	Ø M	
24730	M4-M8	30
24740	M9-M12	25
24750	M13-M18	20

- PL Komplet gwintowników i narzynek  
GB Tap and die set  
D Gewindeschneidwerkzeugsatz  
RUS Набор плашек и метчиков
- CZ Souprava závitníků a kruhových závitových čelistí  
RO Set de tarozi și filiere  
H Menetfúró és menetvágó készlet  
E Juego de machos de roscar y cojinetes



No.	Ø M	
24295	M3x0.5; M4x0.7; M5x0.8; M6x1; M8x1.25; M10x1.5; M12x1.75	10/20

- PL Komplet frezów do drewna  
GB Router bit set  
D Oberfräsesatz  
RUS Набор сверл Форстнера по дереву
- CZ Souprava frézů do dřeva  
RO Set de freze pt. lemn  
H Marókészlet fához  
E Juego de frezas para madera



**VOREL**

No.	Ø (mm)	pcs	
22550	8	12	5/20

- PL Tarcza diamentowa "segment"  
GB Diamond blade segmented  
D Diamanttrennscheibe  
RUS Диск алмазный сегментированный
- CZ Diamantový kotouč segmentový  
RO Disc diamantat segmentat  
H Szegmens gyémántkorong  
E Disco de diamante de segmentos

**VOREL**

No.	Ø (mm)	min-1	
08710	110	12000	20/200
08711	115	12000	20/200
08712	125	11000	20/160
08714	180	8000	15/60
08715	230	6500	10/40

- PL Oprawka do narzynek  
GB Die holder  
D Schneideisenhalter  
RUS Плашкодержатель
- CZ Závitová objímka  
RO Portfilieră  
H Menetvágó tartó  
E Portacojinete



No.	mm	
24800	20x7	30
24810	25x9	25
24813	30x11	25
24820	38x14	30
24823	45x16	20

- PL Wykrętaki do zerwanych śrub  
GB Screw extractor set  
D Schraubensatz  
RUS Экстракторы обломанных болтов
- CZ Vrtáky do přetržených šroubů  
RO Set extractoare pt. prezoane / suruburi  
H Törtsavar kihajtó  
E Destornillador para tornillos arrancados



No.	size / rozmiar	pcs	
24000	1/8" (3.2 mm) - 1/4" (6.3 mm) 1/4" (6.3 mm) - 5/16" (7.9 mm) 5/16" (7.9 mm) - 7/16" (11.1 mm) 7/16" (11.1 mm) - 9/16" (14.3 mm) 9/16" (14.3 mm) - 3/4" (19.0 mm)	5	12/120

- PL Komplet frezów do drewna  
GB Router bit set  
D Oberfräsesatz  
RUS Набор сверл Форстнера по дереву
- CZ Souprava frézů do dřeva  
RO Set de freze pt. lemn  
H Marókészlet fához  
E Juego de frezas para madera



**VOREL**

No.	L (mm)	Ø (mm)	pcs	
22551	15; 20; 25; 30; 35	8	5	5/20



- PL Tarcza diamentowa "segment"  
 GB Diamond blade segmented  
 D Diamantrennscheibe  
 RUS Диск алмазный сегментированный
- CZ Diamantový kotouč segmentový  
 RO Disc diamantat segmentat  
 H Szegmens gyémántkorong  
 E Disco de diamante de segmentos



**STHOR**

No.	Ø (mm)	min-1	
08780	115x7.0x1.9x22.2	13200	20/120
08781	125x7.0x2.0x22.2	12000	20/120
08782	180x7.0x2.3x22.2	8400	15/45
08783	230x7.0x2.4x22.2	6600	10/30

- PL Tarcza diamentowa pełna  
 GB Diamond blade continuous rim  
 D Diamantrennscheibe  
 RUS Диск алмазный сплошной
- CZ Diamantový kotouč /plný/  
 RO Disc diamantat margine continua  
 H Gyémántkorong /teljes/  
 E Disco de diamante /entero/



**STHOR**

No.	Ø (mm)	min-1	
08785	115x5.0x1.9x22.2	13200	20/120
08786	125x5.0x2.0x22.2	12000	20/120
08787	180x5.0x2.3x22.2	8400	15/45
08788	230x5.0x2.4x22.2	6600	10/30

- PL Tarcza diamentowa „Turbo“  
 GB Diamond blade „Turbo“  
 D Diamantrennscheibe tb  
 RUS Отрезной алмазный диск „TURBO“
- CZ Diamantový kotouč /Turbo/  
 RO Disc diamantat Turbo  
 H Gyémántkorong /Turbo/  
 E Disco de diamante /Turbo/



**STHOR**

No.	Ø (mm)	min-1	
08790	115x7.0x2.0x22.2	13200	20/120
08791	125x7.0x2.1x22.2	12000	20/120
08792	180x7.5x2.4x22.2	8400	15/45
08793	230x7.5x2.6x22.2	6600	10/30

- PL Tarcza diamentowa pełna  
 GB Diamond blade continuous rim  
 D Diamantrennscheibe  
 RUS Диск алмазный сплошной
- CZ Diamantový kotouč /plný/  
 RO Disc diamantat margine continua  
 H Gyémántkorong /teljes/  
 E Disco de diamante /entero/



**VOREL**

No.	Ø (mm)	min-1	
08731	115	12000	20/200
08732	125	11000	20/160
08734	180	8000	15/60
08735	230	6500	10/40

- PL Tarcza diamentowa „Turbo“  
 GB Diamond blade „Turbo“  
 D Diamantrennscheibe tb  
 RUS Отрезной алмазный диск „TURBO“
- CZ Diamantový kotouč /Turbo/  
 RO Disc diamantat Turbo  
 H Gyémántkorong /Turbo/  
 E Disco de diamante /Turbo/



**VOREL**

No.	Ø (mm)	min-1	
08751	115	12000	20/200
08752	125	11000	20/160
08754	180	8000	15/60
08755	230	6500	10/40

- PL Brzeszczot diamentowy  
 GB Diamond rod saw  
 D Diamantsägekordel  
 RUS Полотно алмазное
- CZ Lanko pilové diamentové  
 RO Panze diamentate  
 H Fűrészlap-pálca, gyémántbevonatú  
 E Hoja de sierra de diamante



**VOREL**

No.	L (mm)	
27575	300	20/100

- PL Pila tarczowa do drewna z węglikiem wolframu
- GB TCT circular saw blade for wood
- D Kreissägeblatt HM-Bestückt
- RUS Диск пильный с карбидом вольфрама
- CZ Kotoučová pila na dřevo z karbidem wolframu
- RO Ferăstrău circular cu dinți din wolfram pt. lemn
- H Wolframkarbidos körfűrész fához
- E Disco de sierra con carbono de tungsteno



No.	Ø (mm)	Ø d (mm)	R.P.M. max.	D (mm)	metal disc thickness / grubość tarczy (mm)	number of teeth / ilość zębów (T)	
08811	140	20	9600	2.0	1.3	16	25/50
08819	160	20	8300	2.0	1.4	18	25/50
08820	160	30	8300	2.0	1.4	24	25/50
08821	160	30	8300	2.0	1.4	36	25/50
08822	160	20	8300	2.0	1.4	48	25/50
08825	184	30	7400	2.2	1.4	24	10/20
08827	184	30	7400	2.2	1.4	40	10/20
08828	185	20	7400	2.2	1.4	18	10/20
08829	200	30	6500	2.2	1.6	24	10/20
08831	210	30	6500	2.2	1.6	40	10/20
08832	210	30	6500	2.2	1.6	60	10/20
08833	250	30	5400	3.0	1.8	24	10/20
08834	250	30	5400	3.0	1.8	40	10/20
08835	250	30	5400	3.0	1.8	60	10/20
08836	300	30	4500	3.2	2.0	24	10
08837	300	30	4500	3.2	2.0	40	10
08838	300	30	4500	3.2	2.0	60	10
08845	350	30	3800	3.2	2.2	40	10
08851	400	30	3300	3.2	2.2	60	10

- PL Tarcza do cięcia metalu
- GB Metal cutting disc
- D Trennscheibe für metall
- RUS Диск отрезной по металлу

- CZ Souprava kotoučů pro řezání kovu
- RO Set de pânze de tăiat metal
- H Vágókorong készlet fémhez
- E Disco cortador para metal plano

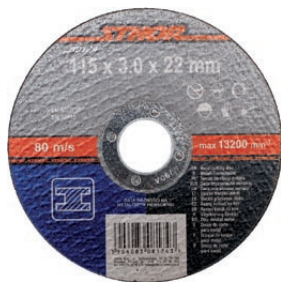

No.	Ø (mm)	min-1	
08170	115x1.0x22	13200	25/200
08174	115x3.0x22	13200	25/200
08171	125x1.0x22	12200	25/200
08175	125x3.0x22	12200	25/200
08177	230x3.0x22	6500	25/50

- PL Pila tarczowa do aluminium z węglikiem wolframu
- GB TCT circular saw blade for aluminium
- D Hartmetallbestückt Kreissägeblatt für aluminium
- RUS Диск пильный по алюминию
- CZ Kotoučová pila na hliník s karbidem wolframu
- RO Disc circular pt. aluminiu
- H Wolframkarbidos körfűrészlap. alumíniumhoz
- E Disco de sierra con carbono

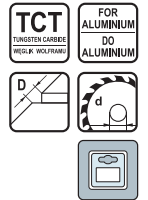

No.	Ø (mm)	Ø d (mm)	R.P.M. max.	D (mm)	metal disc thickness / grubość tarczy (mm)	number of teeth / ilość zębów (T)	
08853	210	30	6500	2.2	1.6	72	10/20
08854	250	30	5400	3.0	1.8	100	10/20
08855	300	30	4500	3.2	2.0	100	10

- PL Tarcza do cięcia metalu
- GB Metal cutting disc
- D Trennscheibe für metall
- RUS Диск отрезной по металлу

- CZ Souprava kotoučů pro řezání kovu
- RO Set de pânze de tăiat metal
- H Vágókorong készlet fémhez
- E Disco cortador para metal plano



No.	Ø (mm)	min-1	
08630	115x1.0x22	12000	25/200
08633	115x2.5x22	13300	25/200
08631	125x1.0x22	11000	25/200
08635	125x2.5x22	12200	25/200
08636	125x3.2x22	12200	25/200
08638	180x2.5x22	8500	25/100
08639	230x1.6x22	6600	25/50
08640	230x3.2x22	6600	25/50
08641	230x2.5x22	6600	25/50
08642	300x3.2x32	5100	10/20
08644	350x3.5x32	4400	10/20
08646	400x4.0x32	3800	10/20

- PL Tarcza do cięcia metalu wypukła
- GB Metal cutting disc – depressed centre
- D Metall-Trennscheibe gewölbt
- RUS Диск отрезной по металлу выпуклый

- CZ Souprava kotoučů pro řezání kovu
- RO Set de pânze de tăiat metal
- H Vágókorong készlet fémhez
- E Disco cortador para metalo concavo



No.	Ø (mm)	min-1	
08656	125x3.2x22	12200	25/200
08658	230x3.2x22	6600	25/50

- PL Tarcza do szlifowania metalu wypukła  
 GB Metal grinding disc - depressed centre  
 D Metall-Schleifscheibe gewölbt  
 RUS Диск шлифовальный по металлу
- CZ Kotouč pro broušení kovu  
 RO Disc pt. șlefuit metal  
 H Vágókorong fémhez  
 E Disco de pulir de metalo



No.	Ø (mm)	min-1	
08663	115x6.0x22	13300	25/100
08665	125x6.8x22	11000	25/100
08669	230x6.8x22	6600	25/50

- PL Tarcza do szlifowania metalu wypukła  
 GB Metal grinding disc - depressed centre  
 D Metall-Schleifscheibe gewölbt  
 RUS Диск шлифовальный по металлу выпуклый
- CZ Kotouč pro broušení kovu  
 RO Disc pt. șlefuit metal  
 H Vágókorong fémhez  
 E Disco de pulir de metalo



No.	Ø (mm)	min-1	
08190	115x6.0x22	13200	25/100
08191	125x6.0x22	12200	25/100
08193	230x6.0x22	6500	10/20

- PL Tarcza do cięcia kamienia wypukła  
 GB Stone cutting disc - depressed centre  
 D Stein-Trennscheibe gewölbt  
 RUS Диск отрезной по камню
- CZ Kotouč pro řezání kamene  
 RO Disc pt. tăiat piatră  
 H Vágókorong kőhöz  
 E Disco cortador de piedra



No.	Ø (mm)	min-1	
08200	115x3.0x22	13200	25/200
08201	125x3.0x22	12200	25/200
08203	230x3.0x22	6500	25/50

- PL Tarcza do cięcia metalu wypukła  
 GB Metal cutting disc - depressed centre  
 D Metall-Trennscheibe gewölbt  
 RUS Диск отрезной по металлу выпуклый
- CZ Souprava kotoučů pro řezání kovu  
 RO Set de pânze de tăiat metal  
 H Vágókorong készlet fémhez  
 E Disco cortador para metalo concavo



No.	Ø (mm)	min-1	
08186	125x3.0x22	12200	25/200
08188	230x3.0x22	6500	25/50

- PL Tarcza do cięcia kamienia  
 GB Stone cutting disc  
 D Stein-Trennscheibe  
 RUS Диск отрезной по камню
- CZ Kotouč pro řezání kamene  
 RO Disc pt. tăiat piatră  
 H Vágókorong kőhöz  
 E Disco cortador de piedra



No.	Ø (mm)	min-1	
08671	115x3.2x22	13200	25/200
08672	125x3.2x22	12200	25/200
08674	230x3.2x22	6600	25/50

- PL Tarcza do szlifowania kamienia wypukła  
 GB Stone grinding disc - depressed centre  
 D Stein-Schleifscheibe gewölbt  
 RUS Диск шлифовальный по камню
- CZ Kotouč pro broušení kamene  
 RO Disc pt. șlefuit piatră  
 H Csizfolókorong kőhöz  
 E Disco de pulir de piedra



No.	Ø (mm)	min-1	
08681	115x6.0x22	13300	25/100
08683	125x6.8x22	11000	25/100

- PL Ściernica listkowa talerzowa  
 GB Abrasive disc  
 D Lameller  
 RUS Диск лепестковый
- CZ Kotouč brusný lamelový  
 RO Disc abraziv  
 H Lamellás csiszoló  
 E Disco abrasivo



No.	type	Ø (mm)	min-1	
07974	P40	115	13300	50/200
07975	P60	115	13300	50/200
07976	P80	115	13300	50/200
07977	P100	115	13300	50/200
07978	P120	115	13300	50/200
07984	P40	125	12300	50/200
07985	P60	125	12300	50/200
07986	P80	125	12300	50/200
07987	P100	125	12300	50/200
07988	P120	125	12300	50/200

- PL Tarcza do szlifierki stolowej  
 GB Grinding disc  
 D Schleifscheibe  
 RUS Круг для настольного точильного станка
- CZ Brusný kotouč  
 RO Discul abraziv  
 H Kőszörűkő  
 E Disco abrasivo



No.	Ø (mm)	min-1		
08860	125x12.7x17	5850	coarse-grained / gruboziamisty	10
08861	125x12.7x17	5850	fine-grained / drobnoziarnisty	10
08864	150x12.7x16	5350	coarse-grained / gruboziamisty	10
08865	150x12.7x17	5350	fine-grained / drobnoziarnisty	10
08868	150x31.75x25	5350	coarse-grained / gruboziamisty	10
08869	150x31.75x25	5350	fine-grained / drobnoziarnisty	10
08873	200x15.88x20	3850	fine-grained / drobnoziarnisty	10
08875	200x31.75x30	3850	fine-grained / drobnoziarnisty	10

- PL Tarcza łańcuchowa  
 GB Chain disc  
 D Kettentrennscheibe  
 RUS Круг отрезной цепной
- CZ Řetězové kolo  
 RO Disc circular pt. lemn  
 H Lánctárcsa  
 E Disco de cadena



No.	Ø (mm)	min-1	
08770	115	12000	10
08771	125	11000	10
08773	230	6800	10

- PL Tarcza do szlifierki stolowej  
 GB Grinding disc  
 D Schleifscheibe  
 RUS Круг для настольного точильного станка
- CZ Brusný kotouč  
 RO Discul abraziv  
 H Kőszörűkő  
 E Disco abrasivo



No.	Ø (mm)	min-1	
08876	200x20x40	3850	5

- PL Nożyce do blachy  
 GB Figure tin snips  
 D Blechscher  
 RUS Ножницы по металлу
- CZ Nůžky na plech  
 RO Foarfeca pt. tablă  
 H Lemezvágó olló  
 E Tijeras para hojalata

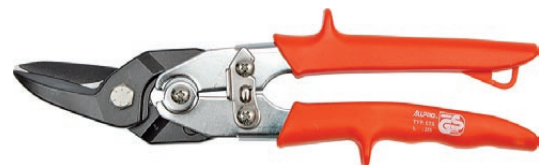

No.	max (mm)	
48000	1.5	6/36

PL Nożyce do blachy  
GB Figure tin snips  
D Blechscher  
RUS Ножницы по металлу

CZ Nůžky na plech  
RO Foarfece pt. tablă  
H Lemezvágó olló  
E Tijeras para hojalata



**VOREL**

No.	max (mm)	
48060	1.2	6/48

PL Nożyce do blachy  
GB Figure tin snips  
D Blechscher  
RUS Ножницы по металлу

CZ Nůžky na plech  
RO Foarfece pt. tablă  
H Lemezvágó olló  
E Tijeras para hojalata



No.	L (mm)	
48100	250	6/60

PL Nożyce do blachy  
GB Figure tin snips  
D Blechscher  
RUS Ножницы по металлу

CZ Nůžky na plech  
RO Foarfece pt. tablă  
H Lemezvágó olló  
E Tijeras para hojalata



No.	L (mm)	
48200	250	6/60

PL Nożyce do blachy  
GB Figure tin snips  
D Blechscher  
RUS Ножницы по металлу

CZ Nůžky na plech  
RO Foarfece pt. tablă  
H Lemezvágó olló  
E Tijeras para hojalata



**VOREL**

No.	max (mm)	
48070	1.2	6/48

PL Nożyce do blachy  
GB Figure tin snips  
D Blechscher  
RUS Ножницы по металлу

CZ Nůžky na plech  
RO Foarfece pt. tablă  
H Lemezvágó olló  
E Tijeras para hojalata



**VOREL**

No.	L (mm)	
48080	250	6/36

PL Nożyce do blachy  
GB Figure tin snips  
D Blechscher  
RUS Ножницы по металлу

CZ Nůžky na plech  
RO Foarfece pt. tablă  
H Lemezvágó olló  
E Tijeras para hojalata



**VOREL**

No.	L (mm)	
48082	250	6/36

PL Nożyce do blachy  
GB Figure tin snips  
D Blechscher  
RUS Ножницы по металлу

CZ Nůžky na plech  
RO Foarfece pt. tablă  
H Lemezvágó olló  
E Tijeras para hojalata



**VOREL**

No.	max (mm)	
48050	1.5	6/36

PL Nożyce do blachy  
GB Figure tin snips  
D Blechscher  
RUS Ножницы по металлу

CZ Nůžky na plech  
RO Foarfece pt. tablă  
H Lemezvágó olló  
E Tijeras para hojalata



**VOREL**

No.	L (mm)	
48081	250	6/36



- PL Nożyce do blachy  
GB Figure tin snips  
D Blechscher  
RUS Ножницы по металлу
- CZ Nůžky na plech  
RO Foarfece pt. tablă  
H Lemezvágo olló  
E Tijeras para hojalata



No.	L (mm)	
48150	250	6/60

- PL Nożyce do drutu  
GB Bolt cutter  
D Drahtschere  
RUS Болторез
- CZ Nůžky na drát  
RO Cleste pt. buioane  
H Drótvágó olló  
E Tijeras para alambre

200 mm

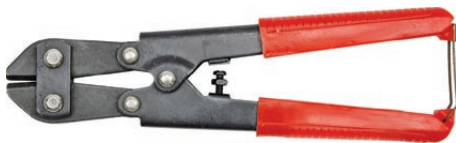

No.	L (mm)	
49200	200	15/60

- PL Nożyce do prętów  
GB Bolt cutter  
D Bolzenschneider  
RUS Болторез
- CZ Nůžky na tyče  
RO Cleste pt. buioane  
H Kábelvágó olló  
E Tijeras para barras



No.	L (mm)	
49450	450	20
49600	600	10
49750	750	5

- PL Pila do drewna  
GB Hand saw for wood  
D Handsäge  
RUS Пила по дереву
- CZ Pila na dřevo  
RO Fierastrău „coada de vulpe” - pt. lemn  
H Fafűrész, egyenes  
E Sierra de mano



No.	L (mm)	
28380	400	10/40
28381	450	10/40
28382	500	10/40

- PL Nożyce do blachy  
GB Figure tin snips  
D Blechscher  
RUS Набор ножниц по металлу
- CZ Nůžky na plech  
RO Foarfece pt. tablă  
H Lemezvágo olló  
E Tijeras para hojalata



No.	L (mm)	pcs	
48330	250	3	5/20

- PL Glowica do nożyc do drutu  
GB Bolt cutter head  
D Schneiden für bolzenschneider  
RUS Головка для болтореза
- CZ Hlava nůžek na tyče  
RO Cap pt. cleste buioane  
H Fej a kábelvágó ollóhoz  
E Cabezal de tijeras para barras



No.	L (mm)	for / dla	
49460	450	49450	10/30
49760	750	49750	5/20

- PL Nożyce do prętów profesjonalne  
GB Bolt cutter  
D Bolzenschneider  
RUS Болторез „ПРОФИ”
- CZ Nůžky na tyče  
RO Cleste pt. buioane  
H Kábelvágó olló  
E Tijeras para barras



No.	L (mm)	Ø (mm)	
49770	350	6	24
49771	450	8	12
49772	600	10	12
49773	750	12	6
49774	900	14	4
49775	1050	16	2

- PL Pila platnica
- GB Hand saw for wood
- D Handsäge
- RUS Пила по дереву
- CZ Pila na dřevo
- RO Fierastrău „coada de vulpe” - pt. lemn
- H Fafűrész, egyenes
- E Sierra de mano



**VOREL**

No.	L (mm)	
28385	400	12/48
28386	450	10/40
28387	500	10/40

- PL Pila kabląkowa
- GB Bow saw
- D Bűgelsäge
- RUS Лучковая пила по дереву
- CZ Oblouková pila
- RO Ferăstrău de curbură
- H Keretes fűrész
- E Sierra de arco

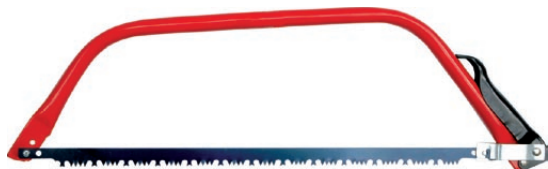

No.	L (mm)	
28740	515	24
28750	735	24

- PL Pila kabląkowa
- GB Bow saw
- D Bűgelsäge
- RUS Лучковая пила по дереву
- CZ Oblouková pila
- RO Ferăstrău de curbură
- H Keretes fűrész
- E Sierra de arco



**FLO**

No.	L (mm)	
28746	610	12/24
28755	760	12/24

- PL Pila otwornica
- GB Compass saw
- D Astsäge
- RUS Пила выкружная
- CZ Pila otwornica
- RO Ferăstrău cu placute de soarece
- H Lyukfűrész
- E Sierra compas

**300 mm**



No.	L (mm)	
28650	300	30/120

- PL Pila do drewna
- GB Hand saw for wood
- D Handsäge
- RUS Пила по дереву
- CZ Pila na dřevo
- RO Fierastrău „coada de vulpe” - pt. lemn
- H Fafűrész, egyenes
- E Sierra de mano



No.	L (mm)	
28394	400	12/60
28395	450	12/60

- PL Pila kabląkowa
- GB Bow saw
- D Bűgelsäge
- RUS Лучковая пила по дереву
- CZ Oblouková pila
- RO Ferăstrău de curbură
- H Keretes fűrész
- E Sierra de arco



**FLO**

No.	L (mm)	
28745	530	12/24

- PL Brzeszczot
- GB Spare blade for bow saw
- D Bűgelsägeblatt
- RUS Полотно для лучковой пилы по сырому дереву
- CZ Ostří na dřevo
- RO Panza fierastrău tip arc
- H Fűrészlap fához
- E Hoja de sierra

**WET WOOD**

**DREWNÓ MOKRE**



**FLO**

No.	L (mm)	W (mm)	
28771	530	20	60/240
28772	610	20	60/240
28773	760	20	60/240

- PL Pila do gazobetonu
- GB Saw for gas concrete
- D Gasbetonsäge
- RUS Пила по газобетону с твердосплавным зубом
- CZ Pila na plynobeton
- RO Fierastrău cu placute vidia pt. BCA
- H Fűrész gázbetonhoz
- E Sierra para gas hormigon

**600 mm**



No.	L (mm)	teeth / zęby	
28000	600	33/33	5
28010	600	33/17	5

PL Pila do gazobetonu  
GB Saw for gas concrete  
D Gasbetonsäge  
RUS Пила по газобетону с  
твердосплавным зубом

CZ Pila na plynobeton  
RO Fierastrău cu placute vidia pt. beton  
H Fűrész gázbetonhoz  
E Sierra para gas hormigon



**VOREL**

No.	L (mm)	teeth / zęby	
28011	600	15	6/12
28012	660	34	6/12

PL Pila do metalu  
GB Hacksaw frame  
D Metallsägebogen  
RUS Ножовка по металлу

CZ Pila na kov  
RO Ferastrău pt. metal  
H Fémfűrész  
E Sierra de metalo

300  
mm



No.	L (mm)	
27100	300	12/60

PL Pila do metalu  
GB Hacksaw frame  
D Metallsägebogen  
RUS Ножовка по металлу

CZ Pila na kov  
RO Ferastrău pt. metal  
H Fémfűrész  
E Sierra de metalo

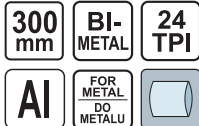

**VOREL**

No.	L (mm)	
27322	300	6/36

PL Pila do metalu  
GB Hacksaw frame  
D Metallsägebogen  
RUS Ножовка по металлу

CZ Pila na kov  
RO Ferastrău pt. metal  
H Fémfűrész  
E Sierra de metalo

150  
mm



No.	L (mm)	
27600	150	30/150

PL Pila do metalu  
GB Hacksaw frame  
D Metallsägebogen  
RUS Ножовка по металлу

CZ Pila na kov  
RO Ferastrău pt. metal  
H Fémfűrész  
E Sierra de metalo

300  
mm



No.	L (mm)	
27000	300	12/48

PL Pila do metalu  
GB Hacksaw frame  
D Metallsägebogen  
RUS Ножовка по металлу

CZ Pila na kov  
RO Ferastrău pt. metal  
H Fémfűrész  
E Sierra de metalo

300  
mm



No.	L (mm)	
27200	300	20/60

PL Pila do metalu  
GB Hacksaw frame  
D Metallsägebogen  
RUS Ножовка по металлу

CZ Pila na kov  
RO Ferastrău pt. metal  
H Fémfűrész  
E Sierra de metalo

300  
mm



**JUCO**

No.	L (mm)	
27495	300	5

PL Pila poprzeczna  
GB Cross-cut saw  
D Bauchsäge  
RUS Пила двуручная

CZ Pila bíchátka  
RO Joagar  
H Keresztvágó fűrész  
E Sierra para corte cruzado

100  
cm



No.	L (cm)	type	
28790	100	L-1000	10

PL Pila kątowa  
GB Precision mitre saw  
D Präzisions-gehrungssäge  
RUS Стусло металлическое „ПРОФИ“

CZ Úhlová pila  
RO Fierastru pt. taiat la unghi  
H Kézifűrész  
E Sierra de angulo

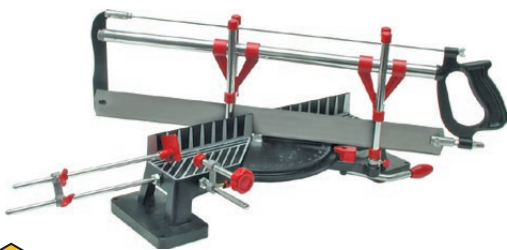

**VOREL**

No.	mm	angle / kąť	
29000	550	22.5°; 30°; 36°; 45°; 90°	1

PL Drewniana skrzynka uciosowa  
GB Wooden mitre box  
D Gehrungsschneidlade  
RUS Стусло деревянное

CZ Ustřihací skřínka dřevěná  
RO Cutie din lemn pt. taiat oblic  
H Vágósablon fa  
E Gria de ingletar de madera



**VOREL**

No.	box / skrzynka (mm)	
29210	300x80	10
29220	450x105	12

PL Skrzynka uciosowa  
GB Plastic mitre box  
D Schneidlade  
RUS Стусло пластмассовое

CZ Ustřihací skřínka z umělé hmoty  
RO Cutie din plastic pt. taiat oblic  
H Vágósablon műanyag  
E Gria de ingletar de plastic



**VOREL**

No.	box / skrzynka (mm)	
29313	280x90	30

PL Skrzynka uciosowa  
GB Plastic mitre box  
D Schneidlade  
RUS Стусло пластмассовое

CZ Ustřihací skřínka z umělé hmoty  
RO Cutie din plastic pt. taiat oblic  
H Vágósablon műanyag  
E Gria de ingletar de plastic



**VOREL**

No.	box / skrzynka (mm)	
29323	325x125	18

PL Pila kątowa uchylna - 2 kąty cięcia  
GB Precision mitre saw - 2 angles  
D Präzisions-gehrungssäge kipbar  
RUS Стусло металлическое наклонное „ПРОФИ“

CZ Úhlová pila sklápěcí  
RO Fierastru de taiat la unghi in doua plane  
H Kézifűrész, dönthető  
E Sierra de angulo desviabile  
2 angulos de corte



**VOREL**

No.	mm	angle / kąť	
29050	550	45°; 55°; 60°; 72°; 90°	1

PL Skrzynka uciosowa  
GB Plastic mitre box  
D Schneidlade  
RUS Стусло пластмассовое

CZ Ustřihací skřínka z umělé hmoty  
RO Cutie din plastic pt. taiat oblic  
H Vágósablon műanyag  
E Gria de ingletar de plastic



**VOREL**

No.	box / skrzynka (mm)	
29311	250x45	70
29312	285x60	50

PL Skrzynka uciosowa  
GB Plastic mitre box  
D Schneidlade  
RUS Стусло пластмассовое

CZ Ustřihací skřínka z umělé hmoty  
RO Cutie din plastic pt. taiat oblic  
H Vágósablon műanyag  
E Gria de ingletar de plastic



**VOREL**

No.	box / skrzynka (mm)	
29317	230x50	50
29318	250x65	50
29319	290x85	30

PL Skrzynka uciosowa  
GB Plastic mitre box  
D Schneidlade  
RUS Стусло пластмассовое

CZ Ustřihací skřínka z umělé hmoty  
RO Cutie din plastic pt. taiat oblic  
H Vágósablon műanyag  
E Gria de ingletar de plastic



PL Brzeczczoty  
GB Hacksaw spare blades  
D Metallsägeblatt  
RUS Полотно двустороннее

CZ Čepele  
RO Pânze  
H Fémfűrészlap  
E Hojas

300 mm



No.	type	L (mm)	W (mm)	pcs packing	box
27500	RAMB	300	25	72	10



No.	type	L (mm)	W (mm)	pcs packing	box
27501	RAMC	300	12	144	10



No.	type	L (mm)	W (mm)	pcs packing	box
27502	RAMA	300	12	144	10



No.	type	L (mm)	W (mm)	pcs packing	box
27505	RAME	300	20	72	10



No.	type	L (mm)	W (mm)	pcs packing	box
27506	RAMF	300	20	72	10



No.	type	L (mm)	W (mm)	pcs packing	box
27510	RAMD	300	25	72	10



No.	type	L (mm)	W (mm)	pcs packing	box
27511	RAMB	300	25	3	50

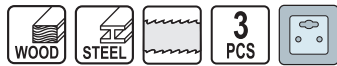

No.	type	L (mm)	W (mm)	pcs packing	box
27513	RAMD	300	25	3	50

PL Brzeczczot do metalu  
GB Spare blade for precision mitre saw for metal  
D Metallsägeblatt  
RUS Полотно для ножовки по металлу  
CZ Pilový list na kovy  
RO Panza fierastrau metale o fata taietoare  
H Fémfűrész lap  
E Hoja de sierra para metalo

12 PCS

300 mm



No.	L (mm)	pcs packing	box
27520	300	12	20/120

PL Brzeczczoty  
GB Hacksaw spare blades  
D Metallsägeblatt  
RUS Полотно по металлу для МИНИ-НОЖОВКИ

CZ Čepele  
RO Pânze  
H Fémfűrészlap  
E Hojas

10 PCS

150 mm



No.	L (mm)	pcs packing	box
27800	150	10	8/120

PL Brzeczczot do drewna i PCV  
GB Spare blade for precision mitre saw for wood & PVC  
D PVC und holzsägeblatt  
RUS Полотно по дереву и ПВХ  
CZ Pilový list na dřevu a PVC  
RO Panza fierastrau pt. lemn si PVC  
H Fűrészlap fához és PVC-hez  
E Hoja de sierra para madera y PVC

550 mm



No.	L (mm)	W (mm)	mm	teeth / inch zęby / cal	box
29090	550	45	0.7	18	50

PL Brzeczczot do metalu  
GB Spare blade for precision mitre saw for metal  
D Metallsägeblatt  
RUS Полотно по металлу  
CZ Pilový list na kovy  
RO Panza fierastrau pt. metal  
H Fémfűrész lap  
E Hoja de sierra para metalo

550 mm



No.	L (mm)	W (mm)	mm	teeth / inch zęby / cal	box
29100	550	45	0.7	32	50

PL Brzeszczyto do wyrzynarki elektrycznej  
 GB Jig saw blades  
 D Stichsägeblätter  
 RUS Полотно для электролобзика

CZ Pilový list do přímočaré pily  
 RO Panza fierastrau circular  
 H Dekopírlap  
 E Recambio sierra de calar



No.	mm	pcs packing	box
27810	100/75	5	100/400



No.	mm	pcs packing	box
27811	100/75	5	100/400



No.	mm	pcs packing	box
27812	100/75	5	100/400



No.	mm	pcs packing	box
27813	100/75	5	100/400



No.	mm	pcs packing	box
27814	76/50	5	100/400



No.	mm	pcs packing	box
27815	100/75	5	100/400



No.	mm	pcs packing	box
27820	4x100/75; 1x76x50	5	100/400

PL Brzeszczyto do wyrzynarki elektrycznej  
 GB Jig saw blades  
 D Stichsägeblätter  
 RUS Полотно для электролобзика

CZ Pilový list do přímočaré pily  
 RO Panza fierastrau circular  
 H Dekopírlap  
 E Recambio sierra de calar



No.	mm	pcs packing	box
27830	100/75	5	100/400



No.	mm	pcs packing	box
27831	100/75	5	100/400



No.	mm	pcs packing	box
27832	76/50	5	100/400



No.	mm	pcs packing	box
27833	100/75	5	100/400



No.	pcs mm	pcs packing	box
27834	4x100/75; 1x76/50	5	100/400

PL Szczotka druciana  
GB Steel wire brush  
D Stahldrahtbürste  
RUS Щетка проволочная стальная

CZ Drátěný kartáč  
RO Perie de sârmă  
H Drótkefe  
E Cepillo de acero



No.	rows / rzędy	
06930	3	12/120
06940	4	12/120
06950	5	12/120
06960	6	12/120

PL Szczotka druciana mosiężna  
GB Brass wire brush  
D Messingdrahtbürste  
RUS Щетка проволочная латунная

CZ Drátěný kartáč mosazný  
RO Perie de sârmă din alamă  
H Réz drótkefe  
E Cepillo de latón



No.	
06965	25/100

PL Szczotka tarczowa, drut karbowany  
GB Circular brush - crimped wire  
D Stahldraht - Kegelbürste  
RUS Щетка-крацевка с гайкой

CZ Kotočový kartáč, rýhovaný drát  
RO Perie rotundă, sârmă ondulată  
H Tarcásás drótkefe, sodrott dróttal  
E Cepillo redondo de alambre ondulado



No.	Ø (mm)	min-1	
06972	100	12500	12/72
06973	115	12500	12/72

PL Komplet szczotek drucianych  
GB Plastic handle wire brush set  
D Stahlbürstensatz  
RUS Набор 3-х мини-щёток

CZ Kartáče  
RO Perie set  
H 3 db-os kefekészlet  
E Juego de 3 cepillos



No.	L (mm)	
06963	170	24/240
06964	220	24/72

PL Szczotka czolowa z gwintem, drut karbowany  
GB Cup brush - crimped wire  
D Stahldraht - Topfbürste  
RUS Щетка-крацевка чашка с гайкой

CZ Čelní kartáč, rýhovaný drát  
RO Perie frontală, sârmă ondulată  
H Homlok drótkefe, sodrott dróttal  
E Cepillo de copa de alambre ondulado



No.	Ø (mm)	min-1	
06970	75	12500	12/72
06971	100	8500	6/24

PL Szczotka czolowa z gwintem, drut splatany  
GB Cup brush - twisted wire  
D Stahldraht - Zopfopfbürste  
RUS Щетка - крацевка круговая крученая щетка крацевка (чашка)

CZ Čelní kartáč, pletený drát  
RO Perie frontală, sârmă împletită  
H Homlok drótkefe, sodrott dróttal  
E Cepillo de copa de alambre conico



No.	Ø (mm)	min-1	
06974	65	12500	12/36
06975	80	8500	12/36
06976	100	8500	6/24

PL Szczotka tarczowa z gwintem, drut splatany  
 GB Circular brush - twisted wire  
 D Stahldraht - Zopf - Kegelmürste  
 RUS Щетка-крацовка усиленная

CZ Kotouřový kartáč, pletený drát  
 RO Perie rotativă, sămă împletită  
 H Tarcás drótkefe, egyenes dróttal  
 E Cepillo redondo de alambre conico



No.	Ø (mm)	min-1	Icon
06977	100	12500	12/48

PL Szczotka tarczowa, drut splatany  
 GB Circular brush - twisted wire  
 D Stahldraht - Zopfscheibenbürste  
 RUS Дисксовая щетка витая

CZ Kotouřový kartáč  
 RO Perie rotativă  
 H Tarcás drótkefe  
 E Cepillo redondo de alambre conico



No.	Ø (mm)	min-1	Icon
06981	100	11000	12/72
06982	115	11000	12/48
06983	150	9000	

PL Szczotka czolowa z trzpieniem, drut karbowany  
 GB Cup brush - crimped wire  
 D Stahldraht - Topfbürste  
 RUS Щетка-крацовка со стержнем чашка  
 CZ Čelní kartáč, z hrotem, rýhovaný drát  
 RO Perie frontală cu coadă, sămă ondulată  
 H Homlok drótkefe, nyéllel, sodrott dróttal  
 E Cepillo de copa con mandril, de alambre ondulado



No.	Ø (mm)	min-1	Icon
06987	50	4500	10/180
06988	75	4500	12/96

PL Szczotki druciane okragle  
 GB Steel wire brush set  
 D Stahldraht - Bürstensatz  
 RUS Набор щеток

CZ Drátěné kartáče kulaté  
 RO Perii de sămă rotunde  
 H Kerek drótkefe  
 E Cepillos de alambre redontos



No.	min-1	Icon
06990	4500	20/120

PL Szczotka tarczowa, drut karbowany  
 GB Circular brush - crimped wire  
 D Stahldraht - Scheibenbürste  
 RUS Щетка-крацовка латунированная сталь

CZ Kotouřový kartáč  
 RO Perie rotativă  
 H Tarcás drótkefe  
 E Cepillo redondo de alambre ondulado



No.	Ø (mm)	min-1	Icon
06978	125	6000	12/72
06979	150	6000	12/36
06980	200	4500	12/24

PL Szczotka tarczowa z trzpieniem, drut karbowany  
 GB Circular brush - crimped wire  
 D Stahldraht - Scheibenbürste mit Dom  
 RUS Щетка-крацовка со стержнем  
 CZ Kotouřový kartáč, z hrotem, rýhovaný drát  
 RO Perie rotundă cu coadă sămă ondulată  
 H Tarcás drótkefe, nyéllel, sodrott dróttal  
 E Cepillo redondo con mandril de alambre ondulado



No.	Ø (mm)	min-1	Icon
06985	75	4500	10/120
06986	100	4500	12/120

PL Szczotki druciane z trzpieniem, drut karbowany  
 GB Wire brush set  
 D Stahldraht-Bürstensatz  
 RUS Набор щеток-крацовок со стержнем

CZ Okružní kartáč drátěný se stopkou  
 RO Set perii sama ondulată  
 H Tarcás drótkefe, nyéllel, sodrott dróttal  
 E Cepillos de alambre con mandril



No.	Ø (mm)	min-1	Icon
06989	25; 50; 50	4500	12/60

PL Szczotka czolowa z trzpieniem, drut karbowany  
 GB Cup brush - crimped wire  
 D Stahldraht - Topfbürste  
 RUS Щетка-крацовка „КИСТЬ” со стержнем  
 CZ Čelní kartáč, z hrotem, rýhovaný drát  
 RO Perie frontală cu coadă, sămă ondulată  
 H Homlok drótkefe, nyéllel, sodrott dróttal  
 E Cepillo de copa con mandril, de alambre ondulado



No.	Ø (mm)	min-1	Icon
06992	24	4500	24/192



- PL Szczotka tarczowa z trzpieniem, drut splatany  
 GB Circular brush - twisted wire  
 D Stahldraht - Zopfscheibenbürste mit Dorn  
 RUS Щетка-крацовка витая  
 CZ Kotoučový kartáč, z hrotem, pletený drát  
 RO Perie rotativă cu coadă sărmă împletită  
 H Tarcás drótkefe, nyéllel, egyenes dróttal  
 E Cepillo redondo con mandril de alambre conico



**VOREL**

No.	Ø (mm)	min-1	Box
06993	75	12500	30/180

- PL Rotoflex przegubowy  
 GB Rotoflex profi  
 D Rotoflex profi  
 RUS Насадка резиновая с фиксатором угла наклона, с липучкой, для дрели
- CZ Kloubový rotoflex  
 RO Suport disc abraziv, fixare scai  
 H Csuklós rotoflex  
 E Rotoflex articulado



125  
Ømm



**PRO  
FIL**

No.	Ø (mm)	min-1	Box
08300	125	2000	20

- PL Przystawka-dysk z trzpieniem  
 GB Rubber disc with arbor  
 D Klett - Haftteller + Ersatzdorn  
 RUS Насадка резиновая с шестигранным хвостовиком, для дрели
- CZ Nástavec-kotouč s upínacím trmem  
 RO Disc cu știft, ajutoraj  
 H Csizkoló korong nyéllel  
 E Disco de goma con mandril

125  
Ømm



**VOREL**

No.	Ø (mm)	min-1	Box
08314	125	3250	30/120

- PL Przystawka do szlifierek kątownych i wiertarek  
 GB Rubber disc for angle grinder and drill machine  
 D Klett - Haftstützteller mit Gewindeflansch und Ersatzdorn  
 RUS Насадка шлифовальная, гайка M14 с липучкой+ переход  
 CZ Kotouč do úhelníků ze zipem  
 RO Suport disc abraziv, fixare scai  
 H Euro lemez élhez, tapadókoronggal  
 E Disco de goma para ancul con mandril

M14 125  
Ømm



**VOREL**

No.	Ø (mm)	min-1	Box
08316	125	12200	30/120

- PL Szczotka czolowa z trzpieniem, drut splatany  
 GB Cup brush - twisted wire  
 D Stahldraht - Zopfgrundbürste  
 RUS Щетка-крацовка витая со стержнем  
 CZ Čelní kartáč, z hrotem, pletený drát  
 RO Perie frontală cu coadă, sărmă împletită  
 H Homlok drótkefe, nyéllel, egyenes dróttal  
 E Cepillo de copa con mandril de alambre conico



**VOREL**

No.	Ø (mm)	min-1	Box
06994	75	12500	12/96
06995	22	4500	24/192

- PL Przystawka z rzepem  
 GB Rubber disc with velcro  
 D Klett - Haftstützteller mit Dorn  
 RUS Насадка резиновая с шестигранным хвостовиком, для дрели
- CZ Přídavné zařízení ze zipem  
 RO Disc-Suport cu scai pt. hárte abrazivă rotundă  
 H Kistál tapadókoronggal  
 E Disco de goma con velcro



125  
Ømm



**VOREL**

No.	Ø (mm)	min-1	Box
08312	125	2000	12/120

- PL Euro dysk do kątowniki z rzepem  
 GB Rubber disc for angle grinder with velcro  
 D Klett - Haftteller + Gewindeflansch  
 RUS Насадка пластиковая жесткая под круг на липучке
- CZ Euro disk do úhelníků ze zipem  
 RO Suport disc abraziv, fixare scai  
 H Euro lemez élhez, tapadókoronggal  
 E Disco de goma para angul con velcro

M14



**VOREL**

No.	Ø (mm)	min-1	Box
08315	125	12200	30/120

- PL Tarcza do kątowniki z rzepem  
 GB Rubber disc for angle grinder with velcro  
 D Klett - Gummihafstützteller mit Gewindeflansch  
 RUS Насадка шлифовальная под круг на липучке  
 CZ Kotouč do úhelníků ze zipem  
 RO Suport disc abraziv, fixare scai  
 H Euro lemez élhez, tapadókoronggal  
 E Disco para el pulidor angular con sujetador Velcro

M14 125  
Ømm



**VOREL**

No.	Ø (mm)	min-1	Box
08318	125	12500	25/100

- PL Tarcza gumowa „multi-dysk” z rzepem  
 GB „MULTI-DYSK” rubber disc with velcro  
 D Gummihaftstützteller  
 RUS Насадка резиновая поворотная с липучкой, для дрели
- CZ Terč multi-dysk ze zipem  
 RO Suport disc abraziv, fixare scai  
 H Multidisc tárcsa tapadókorong  
 E Multi-disco con velcro



PRO  
FIL

No.	Ø (mm)	min-1	☐
08350	125	2000	20

- PL Euro dysk do kątowniki z rzepem  
 GB Rubber disc for angle grinder with velcro  
 D Klett - Haftstützteller mit Gewindeflansch  
 RUS Насадка пластиковая жесткая под круг на липучке
- CZ Euro disk do úhelníků ze zipem  
 RO Euro disc cu scai pt. polizor unghiular  
 H Euro lemez élhez, tapadókoronggal  
 E Disco de goma para angul con velcro



PRO  
FIL

No.	Ø (mm)	min-1	☐
08500	125	10000	20
08510	150	8500	20

- PL Euro dysk do kątowniki z trzpieniem  
 GB Rubber disc for angle grinder  
 D Klett - Haftstützteller mit Gewindeflansch und Ersatzdorn  
 RUS Насадка шлифовальная, гайка M14 с липучкой + переход
- CZ Euro disk do úhelníků  
 RO Euro disc cu scai pt. polizor unghiular  
 H Euro lemez élhez, tapadókoronggal  
 E Disco de goma para ancil con mandril



PRO  
FIL

No.	Ø (mm)	min-1	☐
08501	125	10000	20

- PL Rzep do tarczy gumowej /przylepiec/  
 GB Polishing felt disc  
 D Klettdisk für Gummistützteller  
 RUS Круг с липучкой
- CZ Zip do pryžového kotouče /suchý zip/  
 RO Disc pasla de lustruit cu scai  
 H Tapadókorong gumitárcsához  
 E Velcro para disco de goma



VOREL

No.	Ø (mm)	☐
08520	150	100
08521	125	100

- PL Przystawka z rzepem  
 GB Rubber disc with velcro  
 D Klett - Haftstützteller mit Dorn  
 RUS Насадка резиновая с хвостовиком и липучкой для дрели
- CZ Přídavné zařízení ze zipem  
 RO Suport disc abraziv, fixare scai  
 H Kistál tapadókoronggal  
 E Disco de goma con velcro



PRO  
FIL

No.	Ø (mm)	min-1	☐
08400	125	2000	20
08410	150	2000	20

- PL Przystawka-dysk na śrubę  
 GB Rubber disc (screw)  
 D Fiberscheiben - Stützteller mit Dorn  
 RUS Насадка шлифовальная под круг на липучке и хвостиком
- CZ Přídavné zařízení –disk pro šroubu  
 RO Suport disc abraziv, fixare scai  
 H Tál-lemez csavarozott  
 E Disco de goma /tornillo/



PRO  
FIL

No.	Ø (mm)	min-1	☐
08450	125	2000	20

- PL Tarcza do kątowniki z rzepem nr 2  
 GB Rubber disc for angle grinder with velcro  
 D Klett - Gummihaftstützteller mit Gewindeflansch  
 RUS Насадка шлифовальная под круг на липучке
- CZ Kotouč do úhelníků ze zipem číslo 2  
 RO Disc de păsă cu scai nr. 2 pt. polizor unghiular  
 H Euro lemez élhez, tapadókoronggal, 2 sz.  
 E Disco de goma para angul con velcro



PRO  
FIL

No.	Ø (mm)	min-1	☐
08511	125	10000	20

- PL Filc polerski na rzep  
 GB Polishing felt disc  
 D Filzpolierdisc  
 RUS Полировальная насадка из фетра на липучке
- CZ Leštič polstěnc na zip  
 RO Disc pasla de lustruit cu scai  
 H Polirozó filc tapadókoronggal  
 E Filtro de pulir con velcro



PRO  
FIL

No.	Ø (mm)	min-1	☐
08522	125	10000	100

PL Nóż składany  
GB Folding utility knife  
D Klappmesser  
RUS Нож складной

CZ Kapesní nůž  
RO Briceag  
H Zsebkés  
E Navaja



**VOREL**

No.	mm	Box
76526	61x33x0.5	12/72

PL Nóż składany sierpak  
GB Electrician's knife  
D Montagemeser  
RUS Нож складной

CZ Montážní nůž  
RO Cutit pt. decablat  
H Szerelőkés  
E Cuchillo de montaje



**VOREL**

No.	blade / ostrze (mm)	Box
76622	85	10/100

PL Nóż monterski  
GB Cable knife  
D Montagemeser  
RUS Нож электрика

CZ Montážní nůž  
RO Cutit pt. decablat  
H Szerelőkés  
E Cuchillo de montaje



No.	type	Box
76650	K-508	50

PL Nóż uniwersalny  
GB Utility knife  
D Universalmesser  
RUS Нож универсальный, лезвие трапеция, металлический корпус

CZ Univerzální nůž  
RO Cutter metallic  
H Univerzális kés  
E Cutter universal



No.	blade / ostrze (mm)	Box
76000	61x19	25/200

PL Nóż składany sierpak  
GB Lock knife  
D Klappmesser  
RUS Нож складной

CZ Dřevěný nůž srpek  
RO Cutit secera maner lemn  
H Hajított pengéjű kés, fanyelű  
E Cuchillo falciforme de madera

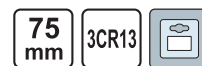

**VOREL**

No.	blade / ostrze (mm)	Box
76621	75	10/100

PL Nóż monterski  
GB Cable knife  
D Montagemeser  
RUS Нож электрика

CZ Montážní nůž  
RO Cutit pt. decablat  
H Szerelőkés  
E Cuchillo de montaje



No.	type	Box
76640	K-506	40

PL Nóż sierpak  
GB Cable knife  
D Klappmesser  
RUS Нож садовый

CZ Dřevěný nůž srpek  
RO Cutit secera maner lemn  
H Hajított pengéjű kés, fanyelű  
E Cuchillo falciforme de madera



No.	type	Box
76660	K-394	50

PL Ostrza zapasowe do 76000  
GB Spare blades for 76000  
D Ersatz-Kurzklingen 5TLG. für 76000/  
RUS Запасные лезвия для ножа 76000

CZ Lomené ostří náhradní  
RO Lama rezerva pt. cutter metallic  
H Törhető tartalékpenge  
E Filos de recambio para cutter univers.



**VOREL**

No.	blade / ostrze (mm)	for / dla	Box
76010	61x19	76000, 76011, 76015	100/600

PL Nóż instalacyjny z magazynkiem  
 GB Cutting knife with blade compartment  
 D Universalmesser  
 RUS Нож обрешитный

CZ Univerzální nůž  
 RO Cutter cu maner metalic si compartiment pt. rezerve  
 H Univerzálnis kés  
 E Cutter con cargador



**VOREL**

No.	blade / ostrze (mm)	
76011	61x19	12/72

PL Nożyk z ostrzem lamany  
 GB Metal utility knife  
 D Messer mit Abbrechklängen  
 RUS Нож пистолетный

CZ Univerzální nůž  
 RO Cutter universal  
 H Univerzálnis kés  
 E Cuchill con filo partido

9 mm



**VOREL**

No.	blade / ostrze (mm)	
76160	9	24/288

PL Nożyk z ostrzem lamany  
 GB Metal utility knife  
 D Messer mit Abbrechklängen  
 RUS Нож пистолетный

CZ Univerzální nůž  
 RO Cutter universal  
 H Univerzálnis kés  
 E Cuchill con filo partido

18 mm



No.	blade / ostrze (mm)	
76181	18	50/400

PL Nożyk z ostrzem lamany  
 GB Metal utility knife  
 D Messer mit Abbrechklängen  
 RUS Нож пистолетный

CZ Univerzální nůž  
 RO Cutter universal  
 H Univerzálnis kés  
 E Cuchill con filo partido

18 mm



**VOREL**

No.	blade / ostrze (mm)	
76183	18	24/144

PL Nożyk z ostrzem trapezowym  
 GB Utility knife  
 D Universalmesser  
 RUS Нож универсальный

CZ Univerzální nůž  
 RO Cutter universal  
 H Univerzálnis kés  
 E Cutter con filo trapezoidal



**VOREL**

No.	blade / ostrze (mm)	
76015	61x19	12/72

PL Nożyk z ostrzem lamany  
 GB Metal utility knife  
 D Messer mit Abbrechklängen  
 RUS Нож пистолетный

CZ Univerzální nůž  
 RO Cutter universal  
 H Univerzálnis kés  
 E Cuchill con filo partido

18 mm



No.	blade / ostrze (mm)	
76180	18	40/400

PL Nożyk z ostrzem lamany  
 GB Metal utility knife  
 D Messer mit Abbrechklängen  
 RUS Нож пистолетный

CZ Univerzální nůž  
 RO Cutter universal  
 H Univerzálnis kés  
 E Cuchill con filo partido

18 mm



**VOREL**

No.	blade / ostrze (mm)	
76182	18	24/240

PL Nożyk z ostrzem lamany  
 GB Metal utility knife  
 D Messer mit Abbrechklängen  
 RUS Нож пистолетный

CZ Univerzální nůž  
 RO Cutter universal  
 H Univerzálnis kés  
 E Cuchill con filo partido

18 mm



**VOREL**

No.	blade / ostrze (mm)	
76184	18	12/120

PL Nożyk z ostrzem lamany  
GB Metal utility knife  
D Messer mit Abbrechklingen  
RUS Нож пистолетный

CZ Univerzální nůž  
RO Cutter universal  
H Univerzálnis kés  
E Cuchill con filo partido

18 mm



No.	blade / ostrze (mm)	
76185	18	60/600

PL Ostrza zapasowe do nożyka  
GB Spare blades  
D Abbrechklingen  
RUS Запасные лезвия

CZ Lomené ostří náhradní  
RO Lame de rezerva pt. cutter  
H Törhető tartalékpenge  
E Filo partido de recambio

5 PCS



VOREL

No.	W (mm)	pcs packing	
76214	25	5	36/288

No.	W (mm)	pcs packing	
76210	9	5	100/600
76220	18	5	100/600

PL Komplet nożyków  
GB All purpose knife set  
D Messersatz  
RUS Набор ножей и скребков

CZ Nůže na tapety  
RO Set cuttere  
H Tapétaolló  
E Juego de cuchillos

5 PCS



No.	pcs	
76250	5	30/150

PL Skrobak do szyb  
GB Window scraper  
D Glasschaber  
RUS Скребок для краски

CZ Škrabák na skla  
RO Răzuitor pt. geamuri  
H Kaparó üveghez  
E Rascador de vidrio

60 mm



No.	blade / ostrze (mm)	
06820	60	50/200

PL Nożyk z ostrzem lamany  
GB Metal utility knife  
D Messer mit Abbrechklingen  
RUS Нож пистолетный

CZ Univerzální nůž  
RO Cutter universal  
H Univerzálnis kés  
E Cuchill con filo partido

25 mm



VOREL

No.	blade / ostrze (mm)	
76190	25	12/72

PL Komplet nożyków  
GB Utility knife set  
D Universalmessersatz  
RUS Ножи пистолетные

CZ Nůže na tapety  
RO Set cuttere  
H Tapétaolló  
E Cuchill con filo partido

3 PCS



No.	pcs	
76230	3	50/200

PL Komplet nożyków  
GB All purpose knife set  
D Messersatz  
RUS Набор ножей и скребков

CZ Nůže na tapety  
RO Set cuttere  
H Tapétaolló  
E Juego de cuchillos

8 PCS



No.	pcs	
76280	8	25/100

PL Nóż do szkła  
GB Glass cutter  
D Glasschneider  
RUS Стеклопоя

CZ Nůž do skla  
RO Diamant pt. sticlă  
H Kés üveghez  
E Cuchillo para cristal



No.		
05100		12/240

PL Nóż olejowy do szkła  
GB Oil glass cutter  
D Ölglasschneider  
RUS Стеклорез масляный

CZ Nůž olejový do skla  
RO Diamant cu ulei pt. sticlă  
H Olajkés üveghez  
E Cuchillo de aceite para cristal



No.		
05050	6/120	

PL Komplet nożyków precyzyjnych z ostrzami  
GB Wood carving knife set  
D Präzisionsmessersatz  
RUS Набор ножей для резбы по дереву

CZ Sada přesných nožů s bity  
RO Set cutite prelucrate lemn  
H Modellező késkészlet pengékkel  
E Juego de cutters precisos con cuchillos



No.	pcs	
76305	16	25/100

PL Komplet nożyczek  
GB Scissors set  
D Haushaltsschensatz  
RUS Ножницы бытовые в наборе

CZ Univerzální nůžky  
RO Foarfece universal  
H Univerzális olló  
E Tijeras universales



No.	L (mm)	pcs	
76314	140; 170; 190; 220; 250	5	12/24

PL Komplet przebijaaków do skóry  
GB Punch set  
D Lederlocherset  
RUS Набор пробойников для кожи

CZ Sada průbojníků na kůži  
RO Set preducele  
H Bőryukasztó készlet  
E Juego de perforar en piel



No.	Ø (mm)	
76705	2.5; 3; 4; 5; 6; 7; 8; 9; 10	10/80

PL Cyklina ręczna, drewniana  
GB Double edge scraper  
D Schaber  
RUS Циклевка с деревянной ручкой

CZ Dřevěná hoblarka ruční  
RO Rascheta dubla (maner lemn)  
H Kézi, fa simító  
E Rascador manual de madera



No.	mm	
06840	40	10
06860	60	10

PL Nożyczki  
GB Scissors  
D Haushaltsschere  
RUS Ножницы

CZ Nůžky  
RO Foarfece  
H Olló  
E Tijeras



No.	L (mm)	
76311	170	12/144
76312	220	12/144

PL Praska do zaciskania nap  
GB Pliers for plastic snaps  
D Zange für plastic moschettoni  
RUS Клещи для пластиковых защелками

CZ Pliers pro plastovou nezapadne  
RO Plastic pliers pt. sporturi  
H Fogó műanyag pattan  
E Alicates para la snaps de plástico



No.	Ø (mm)	
76710	10; 12; 14	30/60

PL Komplet przebijaaków do skóry  
GB Punch set  
D Lederlocherset  
RUS Набор пробойников для кожи

CZ Sada průbojníků na kůži  
RO Set preducele  
H Bőryukasztó készlet  
E Juego de perforar en piel



No.	Ø (mm)	
76700	2; 2.5; 3.2; 4; 4.8; 5.5; 6.4; 8; 9.5; 11.1; 12.7; 14; 15.8; 19; 22	5/20

PL Strug kątnik, czolowy  
GB Rabbet plane  
D Simshobel  
RUS Фальцгельб двойной деревянный

CZ Hoblík čelní drážkovník  
RO Rindea frontală unghiulară  
H Párkánygyalu, homlok  
E Cepillo de ranura



No.	mm	
25830	245x30	20

PL Piłnik do metalu  
GB Steel file  
D Werkstattfeile  
RUS Напильник слесарный

CZ Piłnik na kov  
RO Pila oțel  
H Fémreszelő  
E Lima de metalo



No.	L (mm)	
25160	200	20/100

PL Piłnik do metalu  
GB Steel file  
D Werkstattfeile  
RUS Напильник слесарный

CZ Piłnik na kov  
RO Pila oțel  
H Fémreszelő  
E Lima de metalo



No.	L (mm)	
25162	200	20/100

PL Piłnik do metalu  
GB Steel file  
D Werkstattfeile  
RUS Напильник слесарный

CZ Piłnik na kov  
RO Pila oțel  
H Fémreszelő  
E Lima de metalo



No.	L (mm)	
25164	200	20/100

PL Strug drewniany  
GB Wood plane  
D Putzhobel  
RUS Рубанок отборник деревянный

CZ Dřevěný hoblík  
RO Rindea de lemn  
H Fagyalu  
E Cepillo de madera

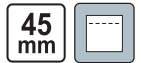

No.	blade width / szerokość ostrza (mm)	type	
25860	45	fine / gładzik	30
25880	45	course / równiak	30

PL Piłnik do metalu  
GB Steel file  
D Werkstattfeile  
RUS Напильник слесарный

CZ Piłnik na kov  
RO Pila oțel  
H Fémreszelő  
E Lima de metalo



No.	L (mm)	
25161	200	20/100

PL Piłnik do metalu  
GB Steel file  
D Werkstattfeile  
RUS Напильник слесарный

CZ Piłnik na kov  
RO Pila oțel  
H Fémreszelő  
E Lima de metalo



No.	L (mm)	
25163	200	20/100

PL Komplet piłników do metalu  
GB Steel file set  
D Werkstattfeilensatz  
RUS Напильники слесарные

CZ Sada piłníků na kov  
RO Set pile oțel  
H Fémreszelő készlet  
E Juego de limas para metalo

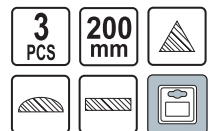

No.	L (mm)	pcs	
25165	200	3	10/20

- PL Komplet pilników do metalu  
GB Steel file set  
D Werkstattfeilensatz  
RUS Напильники слесарные
- CZ Sada pilníků na kov  
RO Set pile otel  
H Fémreszelő készlet  
E Juego de limas para metalo

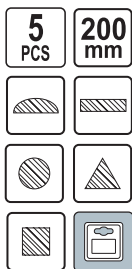

No.	L (mm)	pcs	box
25166	200	5	10/20

- PL Zestaw pilników do metalu „igłaki”  
GB Needle file set  
D Schlüsselfeilensatz  
RUS Набор напильней
- CZ Pilníky na kov jehlové  
RO Set de pile lemn - metal  
H Túreszelő készlet fémhez  
E Limas de metalo agujas



No.	pcs	box
25360	6	20/200

- PL Tarnik do drewna  
GB Wood rasp  
D Holzraspel  
RUS Рашпиль
- CZ Rašple do dřeva  
RO Pile pt. lemn  
H Fareszelő  
E Escarpelo para madera



No.	L (mm)	box
25170	200	20/100

- PL Tarnik do drewna  
GB Wood rasp  
D Holzraspel  
RUS Рашпиль
- CZ Rašple do dřeva  
RO Pile pt. lemn  
H Fareszelő  
E Escarpelo para madera



No.	L (mm)	box
25172	200	20/100

- PL Zestaw pilników do metalu „igłaki”  
GB Needle file set  
D Schlüsselfeilensatz  
RUS Набор напильней
- CZ Pilníky na kov jehlové  
RO Set de pile lemn - metal  
H Túreszelő készlet fémhez  
E Limas de metalo agujas



No.	L (mm)	pcs	packing	box
25370	4x150	5		20/200
25380	4x150	10		25/100
25390	4x150	12		25/100

- PL Zestaw pilników do metalu „igłaki”  
GB Needle file set  
D Schlüsselfeilensatz  
RUS Набор напильней
- CZ Pilníky na kov jehlové  
RO Set de pile lemn - metal  
H Túreszelő készlet fémhez  
E Limas de metalo agujas



No.	L (mm)	pcs	box
25351	140	6	20/160
25352	160	6	20/160
25353	180	6	20/120

- PL Tarnik do drewna  
GB Wood rasp  
D Holzraspel  
RUS Рашпиль
- CZ Rašple do dřeva  
RO Pile pt. lemn  
H Fareszelő  
E Escarpelo para madera



No.	L (mm)	box
25171	200	20/100

- PL Komplet tarników do drewna  
GB Wood rasp set  
D Holzraspelsatz  
RUS Набор рашпильей
- CZ Rašple do dřeva  
RO Set pile pt. lemn  
H Faráspoly készlet  
E Juego de escarpelos para madera

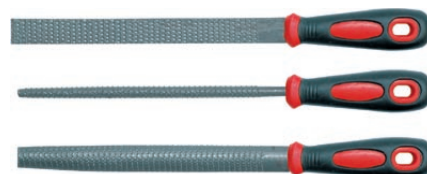

No.	L (mm)	pcs	box
25173	200	3	10/20



PL Komplet tarników do drewna  
GB Wood rasp set  
D Holzraspelsatz  
RUS Набор рашпелей

CZ Rašple do dřeva  
RO Set pile pt. lemn  
H Farásply készlet  
E Juego de escarpelos para madera

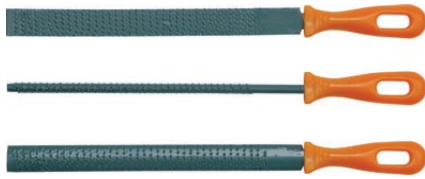

No.	L (mm)	pcs	
25230	200	3	15/60

PL Oselka owalna  
GB Sharpening stone  
D Abziehstein  
RUS Брусок

CZ Obtahovací brousek  
RO Pila abraziva pt. ascuțit  
H Fenőkő  
E Piedra de afilar



No.	L (mm)	
26210	225	50/100

PL Papier ścierny wodoodporny  
GB Waterproof sand paper  
D Schleifpapier wasserfest  
RUS Бумага наждачная-водостойкая

CZ Smirkový papír vodní  
RO Hartie abraziva rezistenta la apa  
H Csiszolópapír vizes  
E Papel de lija resistente al agua



No.	mm	pcs packing	
07650	230x280	15	80

PL Piótno ścieme  
GB Abrasive cloth  
D Schleifgewebe  
RUS Бумага наждачная на тканевой основе

CZ Brusné platno  
RO Pânză abrazivă  
H Csiszolóvászon  
E Paño abrasivo



PL Oselka  
GB Sharpening stone  
D Abziehstein  
RUS Брусок

CZ Obtahovací brousek  
RO Pila abraziva pt. ascuțit  
H Fenőkő  
E Piedra de afilar

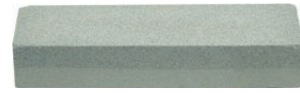

No.	L (mm)	
26150	150	25/50
26200	200	25/50

PL Papier ścierny wodoodporny  
GB Waterproof sand paper  
D Schleifpapier wasserfest  
RUS Бумага наждачная-водостойкая

CZ Smirkový papír vodní  
RO Hartie abraziva rezistenta la apa  
H Csiszolópapír vizes  
E Papel de lija resistente al agua



No.	type	mm	pcs packing	
07060	P60	230x280	50	1000
07080	P80	230x280	50	1000
07100	P100	230x280	50	1000
07120	P120	230x280	50	1000
07180	P180	230x280	50	1000
07240	P240	230x280	50	1000
07320	P320	230x280	50	1000
07400	P400	230x280	50	1000
07506	P600	230x280	50	1000
07508	P800	230x280	50	1000
07510	P1000	230x280	50	1000
07512	P1200	230x280	50	1000



No.	type	mm	pcs packing	
07530	P36	230x280	50	500
07540	P46	230x280	50	500
07560	P60	230x280	50	500
07580	P80	230x280	50	500
07610	P100	230x280	50	500
07620	P120	230x280	50	500
07630	P150	230x280	50	500

PL Siatka ścierna  
GB Abrasive mesh  
D Schleifgitter  
RUS Шлифовальная сетка

CZ Brusné pletivo  
RO Plasă abrazivă  
H Csiszolóháló  
E Red abrasiva nacional



No.	type	mm	pcs
07879	P40	105x280	50
07880	P60	105x280	50
07881	P80	105x280	50
07882	P100	105x280	50
07883	P120	105x280	50
07884	P150	105x280	50
07885	P180	105x280	50
07886	P220	105x280	50

PL Siatka ścierna  
GB Abrasive mesh  
D Schleifgitter  
RUS Шлифовальная сетка

CZ Brusné pletivo  
RO Plasă abrazivă  
H Csiszolóháló  
E Red abrasiva nacional

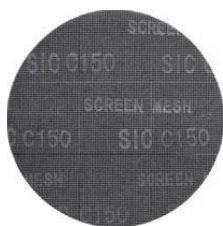

No.	type	Ø (mm)	for / dla	pcs	packing
07652	P150	225	79310 79311 79313	10	50

PL Kostka ścierna  
GB Abrasive sponge  
D Schleifschwamm  
RUS Губка для шлифования

CZ Hubka brusná  
RO Burete abraziv  
H Dörzsszivacs  
E Esponja abrasiva



No.	type	mm	pcs
08288	P60	68x100x25	50
08289	P80	68x100x25	50
08290	P100	68x100x25	50
08291	P120	68x100x25	50
08292	P150	68x100x25	50
08293	P180	68x100x25	50

PL Siatka ścierna  
GB Abrasive mesh  
D Schleifgitter  
RUS Шлифовальная сетка

CZ Brusné pletivo  
RO Plasă abrazivă  
H Csiszolóháló  
E Red abrasiva nacional

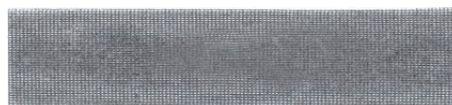

No.	type	mm	pcs	packing
07891	P60	105x280	5	10
07894	P120	105x280	5	10

PL Taśma ścierna bezkońcowa  
GB No end abrasive band  
D Schleifband  
RUS Лента шлифовальная бесконечная

CZ Pás brusný nekonečný  
RO Banda abraziva  
H Végtelenített csiszolószalag  
E Banda abrasiva sin extremos



No.	type	mm	pcs	packing
07664	P40	75x533	5	20/60
07665	P60	75x533	5	20/60
07666	P80	75x533	5	20/60
07667	P100	75x533	5	20/60
07668	P120	75x533	5	20/60

PL Kostka ścierna  
GB Abrasive sponge  
D Schleifschwamm  
RUS Шлифовальная сетка

CZ Hubka brusná  
RO Burete abraziv  
H Dörzsszivacs  
E Esponja abrasiva

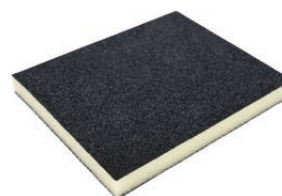

No.	type	mm	pcs
07910	P46	124x98x12	100
07911	P60	124x98x12	100
07912	P80	124x98x12	100
07913	P100	124x98x12	100
07914	P120	124x98x12	100
07915	P150	124x98x12	100
07916	P180	124x98x12	100

- PL Kostka ściema  
GB Abrasive sponge  
D Schleifschwamm  
RUS Шлифовальная сетка
- CZ Hubka brusná  
RO Bureta abraziv  
H Dörzsszivacs  
E Esponja abrasiva

125x90x65x25  
mm

ALOXITE COATING  
NASYP  
ELEKTROKORUND

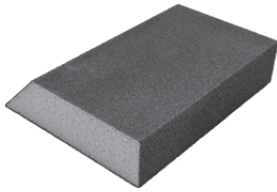

No.	type	mm	pcs	packing
08301	P60	125x90x65x25	100	
08302	P80	125x90x65x25	100	
08303	P100	125x90x65x25	100	
08304	P120	125x90x65x25	100	
08306	P150	125x90x65x25	100	
08307	P180	125x90x65x25	100	
08308	P220	125x90x65x25	100	

- PL Krążek ścierny z otworami  
GB Abrasive disc with holes with velcro  
D Fiberschleifscheiben gelocht  
RUS Круг шлифовальный перфорированный для липучки
- CZ Brusný kotouč z otvorami  
RO Disc abraziv cu orificii  
H Csiszolótárcsa /tapadókoronggal/  
E Juego de discos abrasivos con agujeros

5 PCS 125 Ømm

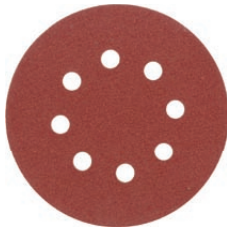

No.	type	Ø (mm)	pcs	packing
08573	P36	125	5	50/200
08574	P40	125	5	50/200
08576	P60	125	5	50/200
08578	P80	125	5	50/200
08580	P100	125	5	50/200
08582	P120	125	5	50/200
08585	P150	125	5	50/200

- PL Blok ścierny gumowy  
GB Sanding block  
D Gummischleifklotz  
RUS Брусок для шлифования резиновый
- CZ Brusný blok pryžový  
RO Suport smirghel  
H Csiszolóblokk, gumi  
E Bloque abrasivo de goma

70x125 mm



No.	mm	pcs	packing
07920	70x125	15	60

- PL Krążek ścierny z rzepem  
GB Abrasive disc with velcro  
D Fiberschleifscheiben ungelocht  
RUS Круг шлифовальный на липучке
- CZ Brusný kotouč /zip/  
RO Disc abraziv (scai)  
H Csiszolótárcsa /tapadókoronggal/  
E Juego de discos abrasivos /velcro/

5 PCS HOOK FASTENER Z RZEPEM

125 Ømm



No.	type	Ø (mm)	pcs	packing
08553	P36	125	5	50/200
08554	P40	125	5	50/200
08556	P60	125	5	50/200
08558	P80	125	5	50/200
08560	P100	125	5	50/200
08562	P120	125	5	50/200
08565	P150	125	5	50/200

- PL Arkusze ścierny z otworami  
GB Abrasive sheets with holes  
D Schleifbogen gelocht  
RUS Шлифовальная бумага перфорированная
- CZ Brusné archy /z otvorami/  
RO Hartie abraziva cu orificii  
H Csiszolóív /lyukakkal/  
E Ojas abrasivas /con agujer/

5 PCS 93x240 mm



No.	type	mm	pcs	packing
08533	P36	93x240	5	50/200
08534	P40	93x240	5	50/200
08536	P60	93x240	5	50/200
08538	P80	93x240	5	50/200
08540	P100	93x240	5	50/200
08542	P120	93x240	5	50/200
08545	P150	93x240	5	50/200

- PL Blok ścierny  
GB Sanding block  
D Handschleifer  
RUS Брусок для шлифования
- CZ Brusný blok  
RO Suport smirghel  
H Csiszolóblokk  
E Bloque abrasivo



No.	mm	pcs	packing
07950	85x160	20	100

No.	mm	pcs	packing
07970	100x210	20	80

PL Blok ścierny skręcany  
 GB Sanding block  
 D Handschleifer  
 RUS Тёрка для шлифования

CZ Brusný blok  
 RO Suport smirghel  
 H Csiszolóblokk  
 E Bloque abrasivo

220x100  
 mm



PL Blok ścierny zatrask  
 GB Sanding block  
 D Handschleifer  
 RUS Тёрка для шлифования

CZ Brusný blok  
 RO Suport smirghel  
 H Csiszolóblokk  
 E Bloque abrasivo

210x105  
 mm



8

No.	mm	
07960	220x100	30

No.	mm	
07962	210x105	30

Memo	
------	--

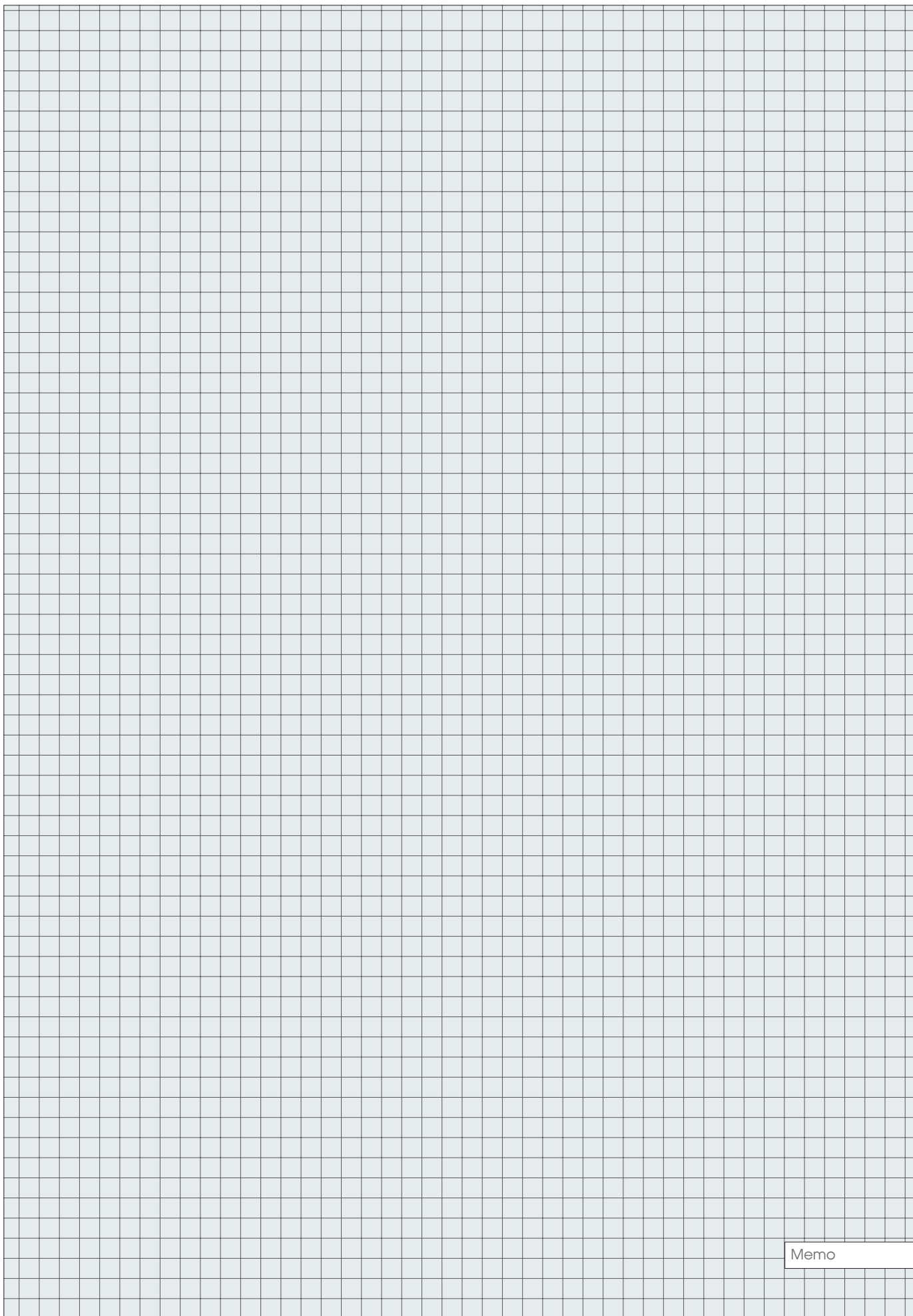

Memo



# 9

## Hydraulic tools Narzędzia hydrauliczne



**Ratchet die stocks**  
Komplety gwintownic ręcznych

.....110

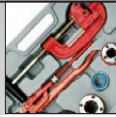

**Hinged pipe vices**  
Imadła zaciskowe do rur

.....110

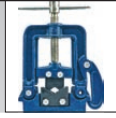

**Water pump pliers**  
Szczypce nastawne

.....110



**Pipe wrenches**  
Klucze do rur

.....110-111



**Pipe wrenches Stillson type**  
Klucze do rur typu Stillson.....

110

**Adjustable pipe wrenches**  
Klucze do rur nastawne.....

111

**Adjustable wrenches**  
Klucze nastawne francuskie.....

111

**Chain pipe wrenches**  
Klucze do rur łańcuchowe

.....111



**Pipe cutters**  
Obcinaki do rur

.....112



**Calibrators**  
Kalibratory

.....112



**Pipe welders**  
Zgrzewarki do rur

.....112-113



**Burners & soldering tools**  
Palniki i lutownice

.....113



**Hydraulic accessories**  
Akcesoria hydrauliczne

.....114-115



- PL Zestaw narzędzi hydraulicznych  
 GB Plumbing tool set  
 D Hydraulischer Werkzeugkasten  
 RUS Набор сантехнического инструмента
- CZ Soustava hydraulických nářadí  
 RO Trusa instalator pt. tevi  
 H Csőszereelő szerszámkészlet  
 E Juego de herramientas de fontanero

12  
PCS



No.	size / rozmiar	pcs	☐
55800	1/4" (6.3 mm); 3/8" (10.0 mm); 1/2" (12.5 mm); 3/4" (19.0 mm); 1" (25.0 mm); 5/4" (32.0 mm)	12	2

- 9 PL Zestaw gwintownic  
 GB Ratchet die stock  
 D Schneidkluppensatz  
 RUS Набор резьбоварезной сантехнический
- CZ Sada závitníků  
 RO Set de filiere  
 H Menetfúró készlet  
 E Juego de roscar

6  
PCS



No.	size / rozmiar	pcs	☐
55830	1-1/2" (38 mm); 2" (50 mm)	6	2

- PL Szczypce hydrauliczne nastawne  
 GB Water pump pliers  
 D Wasserpumpenzange  
 RUS Ключи переставные
- CZ Keleşté siko  
 RO Ciste papagal  
 H Vízpumpaágó  
 E Alicates de fontanero ajustables

250  
mm



9mm  
JAWS WIDTH  
GRUBOS: SZCZEPY



No.	L (mm)	☐
41510	250	10/50

- PL Zestaw gwintownic  
 GB Ratchet die stock  
 D Schneidkluppensatz  
 RUS Набор резьбоварезной сантехнический
- CZ Sada závitníků  
 RO Set de filiere  
 H Menetfúró készlet  
 E Juego de roscar

8  
PCS



No.	size / rozmiar	pcs	☐
55820	3/8" (10.0 mm); 1/2" (12.5 mm); 3/4" (19.0 mm); 1" (25.0 mm); 5/4" (32.0 mm)	8	4

- PL Imadło zaciskowe do rur  
 GB Hinged pipe vice  
 D Rohrschraubstock  
 RUS Тиски для труб
- CZ Upinací svěrák na trubky  
 RO Menghină pt. țevi  
 H Satu, csőszorító  
 E Tornillo de apriete para tubos

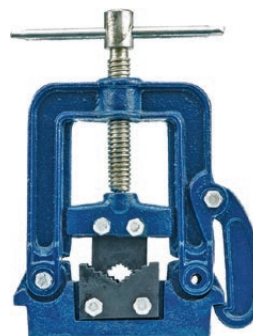

No.	mm	☐
36570	13-50	6

- PL Klucz do rur  
 GB Pipe wrench  
 D Rohrschlüssel  
 RUS Ключ трубный
- CZ Klíč součásti na trubky  
 RO Cheie reglabila pt. țevi  
 H Csőkulcs  
 E Llave de fontanero

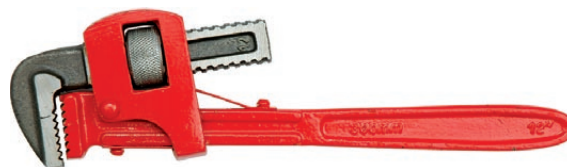

No.	L (mm)	☐
55250	250	6/48
55300	300	6/36
55350	350	6/24



PL Klucz do rur  
GB Pipe wrench  
D Rohrschlüssel  
RUS Ключ трубный

CZ Klíč součástí na trubky  
RO Cheie pt. țevi  
H Csőkulcs  
E Llave de fontanero



No.	L (mm)	
55620	200	6/60
55625	250	6/36
55630	300	6/24
55635	350	4/16
55645	450	3/12
55660	600	3/6
55690	900	2/4

PL Klucz nastawny do rur  
GB Adjustable pipe wrench  
D Rohrschlüssel  
RUS Ключ трубный

CZ Nastavitelný klíč na trubky  
RO Cheie reglabilă pt. țevi  
H Állítható csőkulcs  
E Llave de vaso para tubería



No.	size / rozmiar	
55215	1.0" (25 mm)	24
55216	1.5" (38 mm)	16
55217	2.0" (50 mm)	8

PL Klucz nastawny francuski  
GB Adjustable wrench  
D Stahlschraubenschlüssel /franzose/  
RUS Ключ разводной

CZ Nastavitelný klíč francúz  
RO Cheie reglabilă franceză  
H Állítható franciakulcs  
E Llave ajustable inglesa



No.	KNF	jaws range / zakres szczęk (mm)	jaws width / szerokość szczęk (mm)	
54499	45	0-45	80	10
54500	55	0-55	90	5
54510	65	0-65	100	5

PL Klucz nastawny do rur  
GB Adjustable pipe wrench  
D Rohrschlüssel  
RUS Ключ трубный

CZ Nastavitelný klíč na trubky  
RO Cheie reglabilă pt. țevi  
H Állítható csőkulcs  
E Llave de vaso para tubería



No.	size / rozmiar	
55100	1.0" (25 mm)	12/36
55150	1.5" (38 mm)	10/20
55200	2.0" (50 mm)	6/12

PL Klucz nastawny do rur  
GB Adjustable pipe wrench  
D Rohrschlüssel  
RUS Ключ трубный

CZ Nastavitelný klíč na trubky  
RO Cheie reglabilă pt. țevi  
H Állítható csőkulcs  
E Llave de vaso para tubería



No.	size / rozmiar	
55210	1.0" (25 mm)	24
55211	1.5" (38 mm)	16
55212	2.0" (50 mm)	8

PL Klucz nastawny do rur  
GB Adjustable pipe wrench  
D Rohrschlüssel  
RUS Ключ трубный

CZ Nastavitelný klíč na trubky  
RO Cheie reglabilă pt. țevi  
H Állítható csőkulcs  
E Llave de vaso para tubería



No.	size / rozmiar	
55220	1.0" (25 mm)	24
55221	1.5" (38 mm)	16
55222	2.0" (50 mm)	8

PL Klucz łańcuchowy do rur  
GB Chain pipe wrench  
D Kettenrohrzange  
RUS Цепной ключ для труб

CZ Klíč řetězový na trubky  
RO Cheie reglabilă pt. țevi cu lant  
H Láncos csőfőgő  
E Llave de cadena



No.	L (mm)	max. pipe diameter / max. średnica rury	
55792	300	4" (100 mm)	30

PL Obcinak do rur  
GB Pipe cutter  
D Rohrabscneider  
RUS Труборез для труб из цветных металлов

CZ Řezač trubek  
RO Clește pt. tăiat țevi  
H Csővágó olló csövekhez  
E Cortatubos

∅ 1/10"-5/4"  
∅ 3-32 mm

PLASTIC  
Al, Cu

WITH DEBURRER  
Z GRATOWNIKIEM

BEARING STEEL  
STAL ŁOŻYSKOWA

SPARE CUTTING WHEEL  
ZAPASOWA KŁÓCZKA TRĄB



No.	∅ mm	
78381	1/10"-5/4" (3-32 mm)	60

PL Przecinak do rur PCV  
GB PVC pipe cutter  
D PVC Rohrabscneider  
RUS Труборез для пластиковых труб

CZ Řezač PVC trubek  
RO Clește pt. tăiat țevi din PVC  
H Csővágó olló PVC csövekhez  
E Cortatubos PVC para

∅ max (mm)  
42

PVC  
PP  
PU  
PE

STAINLESS STEEL BLADE  
OSTRZE ZE STALI  
NIEODDZWIĘŻLI  
8Cr13

HRC  
54



No.	max (mm)	
78341	42	12/48

PL Zgrzewarka do rur termoplastycznych  
GB PVC plastic pipe welder  
D Schweissgerät für thermoplastische Rohre  
RUS Аппарат для сварки пластиковых труб

230V~  
50Hz

800  
W

0-300  
°C

IPX4

∅ 16, 20, 25  
[mm] 32, 40, 50



No.	W	
78911	800	5

PL Gratownik do rur  
GB Plastic pipe edging tool  
D Aussen- und innenentgraten werkzeug  
RUS Наружный/внутренний гратосниматель

CZ Odhrotač kombinovaný vnitřní / vnější  
RO Dispozitiv pt. sanfren țevi  
H Loscolótómló csatlakozó  
E Escariador bilateral de tubos

∅  
6-36  
mm



No.	mm	
78385	6-36	25/50

PL Kalibrator do rur  
GB Pipe calibration tool  
D Kalibrierer für Mehrschichtverbundrohr  
RUS Калибратор пластиковый

CZ Kalibrátor na trubky  
RO Calibrator teava multistrat  
H Ötrétegű cső kalibráló  
E Calibrador para tubos multicapa

PE-RT  
AL  
PE-RT

PEX  
AL  
PEX

∅10x16  
∅12x20  
∅14x26  
mm

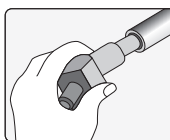

10 mm  
12 mm  
14 mm  
16 mm  
20 mm  
26 mm

14 mm  
16 mm  
18 mm  
20 mm  
25-26 mm  
32 mm



No.		
55740		300

PL Zgrzewarka do rur termoplastycznych  
GB PVC plastic pipe welder  
D Schweissgerät für thermoplastische Rohre  
RUS Аппарат для сварки пластиковых труб

230V~  
50Hz

∅ [mm]  
20, 25, 32  
40, 50, 63

750  
W

IPX0

1500  
W

0-300  
°C



No.	W	
78912	750-1500	4

- PL Zgrzewarka do rur termoplastycznych  
 GB PVC plastic pipe welder  
 D Schweissgerät für thermoplastische Rohre  
 RUS Аппарат для сварки пластиковых труб  
 CZ Svářečka na termoplastické trubky  
 RO Hegeștő berendezés termoplasztikus csövekhez  
 H Masina de sudat tevi termoplastice  
 E Máquina de soldar los tubos termoplasticos

230V~ 50Hz	∅ [mm] 16 20, 25, 32 40, 50, 63	IPX4
I-800W II-1500W	0-300 °C	



**POWER UP**

No.	W	
78910	800-1500	5

- PL Palnik gazowy  
 GB Gas blow torch  
 D Lötbrenner  
 RUS Газовая горелка
- CZ Plynový hořák  
 RO Arzator pe gaz  
 H Gázégő  
 E Soplete de gas

PIEZO	1.3 kW
1300 °C	
BUTANE BUTAN	



EURO TYPE EN417

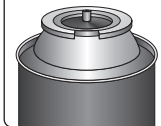

**VOREL**

No.	
73412	10/60

- PL Gazowa lampa lutownicza  
 GB Gas soldering lamp  
 D Gaslötlampe  
 RUS Газовая паяльная лампа
- CZ Plynová pájecí lampa  
 RO Lampă de lipit pe gaz  
 H Gázos forrasztólámpa  
 E Lampa de gas para soldar

1200°C max.	1.7 kW	123 g/h
CARTRIDGE 190g	BUTAN	COMPOSITE BODY PLASTIKOVY KORPUS



**VOREL**

No.	kW	
73400	1.7	12

- PL Lutownica gazowa 3 w 1  
 GB Soldering tool 3 in 1  
 D Gaslötkolben 3 in 1  
 RUS Газовый паяльник 3-в-1  
 CZ Plynová pajka 3 in 1  
 RO Ciocan de lipit cu gaz 3 in 1  
 H Gaz-forrasztópaka 3 in 1  
 E Soldador de gas 3 in 1

SOLDERING LUTOWANIE		450°C
HOT SHRINKING OPALANIE		600°C
TORCH PALNIK		1300°C

15 ml	25-80 W
60 min	BUTANE lighter gas BUTAN gaz do zapalniczki
	PROPANE-BUTANE lighter gas PROPAN-BUTAN gaz do zapalniczki



**VOREL**

No.	
73410	12/48

- PL Palnik gazowy  
 GB Gas blow torch  
 D Lötbrenner  
 RUS Газовая горелка
- CZ Plynový hořák  
 RO Arzator pe gaz  
 H Gázégő  
 E Soplete de gas

PIEZO	1.3 kW
1300 °C	
BUTANE BUTAN	



EURO TYPE EN417

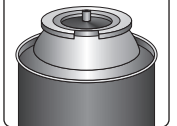

**VOREL**

No.	
73413	10/60

- PL Gazowa lampa lutownicza PIEZO  
 GB Gas soldering lamp  
 D Gaslötlampe  
 RUS Лампа паяльная газовая с пьезоподжигом
- CZ Plynová pájecí lampa  
 RO Lampă de lipit pe gaz  
 H Gázos forrasztólámpa  
 E Lampa de gas para soldar

PIEZO ELECTRIC	1200°C max.	1.7 kW
123 g/h	CARTRIDGE 190g	BUTAN
		METAL COVER METALOVY KORPUS



**VOREL**

No.	kW	
73403	1.7	12

- PL Taśma PTFE  
GB PTFE tape  
D Teflonband  
RUS Фумлента
- CZ Teflonová páska  
RO Bandă de teflon  
H Teflon szalag  
E Cinta de teflón



No.	W (mm)	thickness / grubość (mm)	L (m)	
75200	12	0.075	10	12/2400

- PL Pasta uszczelniająca do gwintów  
GB Thread sealing paste  
D Paste zum Abdichten der Gewinde  
RUS Паста для герметизации резьбы  
CZ Těsnící pasta na závity  
RO Pastă etanșantă pt. filet  
H Menettömítő paszta  
E Pasta selladora para roscas

FOR WATER / HEATING / GAS / AIR  
DO WODY / C.O. / GAZU / POWIETRZA



No.	g	
86750	65	48
86751	250	48

- PL Pakuly lniane  
GB Oakum  
D Leinenwerg  
RUS Лен сантехнический
- CZ Lněná koudel  
RO Călij de in  
H Len kóc  
E Estopa de lino



No.	g	
86760	100	50

- PL Pasta poślizgowa do rur PCV  
GB Lubricant for PVC pipes  
D Gleitpaste für PVC-Rohre  
RUS Силиконовая смазка для ПВХ труб
- CZ Kluzná pasta na PVC trubky  
RO Pastă glisantă pt. țevi PVC  
H Sikosító paszta PVC csövekhez  
E Pasta de deslizamiento para tubos de PCV



No.	g	
86770	250	18
86771	500	15

- PL Taśma PTFE  
GB PTFE tape  
D Teflonband  
RUS Фумлента
- CZ Teflonová páska  
RO Bandă de teflon  
H Teflon szalag  
E Cinta de teflón



No.	W (mm)	thickness / grubość (mm)	L (m)	
75201	12	0.1	12	250/1000
75202	19	0.2	15	200

- PL Pasta uszczelniająca do gwintów  
GB Thread sealing paste  
D Paste zum Abdichten der Gewinde  
RUS Паста для герметизации резьбы  
CZ Těsnící pasta na závity  
RO Pastă etanșantă pt. filet  
H Menettömítő paszta  
E Pasta selladora para roscas

FOR WATER / HEATING / GAS / AIR  
DO WODY / C.O. / GAZU / POWIETRZA



No.	g	
86752	360	48

- PL Hydrauliczny zestaw naprawczy  
GB Hydraulic repair kit  
D Hydraulischer Reparatursatz  
RUS Комплект для уплотнения резьбы
- CZ Hydraulická opravárenská souprava  
RO Set de reparatii pt. instalatori  
H Vízvezeték javító készlet  
E Juego para reparaciones hidráulicas



No.	
86761	40

- PL Pistolet do udrażniania rur  
GB Drain cleaner  
D Pistole zum Reinigen von Rohren  
RUS Пневматический лиственный для прочистки труб
- CZ Pistole na čištění trubek  
RO Pistol pt. curățarea țevilor  
H Csőtisztító pisztoly  
E Pistola destapacaños



No.	Ø (mm)	
55500	135	10



PL Pompa do udrażniania kanalizacji  
 GB Drain suction pump  
 D Hochdruck-Rohrreiniger  
 RUS Пневматический вантуз для прочистки труб

CZ Čerpadlo na čištění trubek  
 RO Pompă pt. curățarea țevilor  
 H Csőtisztító szivattyú  
 E El desagüe del fregadero limpiador



No.	Ø (mm)	Box
55505	65; 155	24

PL Spirala kanalizacyjna  
 GB Drain auger  
 D Hand-Rohrreinigungsspirale  
 RUS Трос сантехнический для чистки труб

CZ Spirála kanalizační  
 RO Dispozitiv de desfundat scurgere  
 H Csőtisztító spirál  
 E Desatascador espiral



No.	Ø (mm)	L (m)	Box
55541	5	1.5	20/80
55542	6	3	18/36

PL Przepychacz do udrażniania kanalizacji  
 GB Pipe cleaner  
 D Räumdorn zum Reinigen der Kanalisation  
 RUS Трос сантехнический, щетка-ерш для прочистки труб  
 CZ Tlakový čistič kanalizace  
 RO Piston pt. deblocarea canalizării  
 H Lefolyótisztító pumpa  
 E Bomba destapacaños

2  
PCS

65  
cm



No.	L (cm)	pcs	Box
55531	65	2	36

PL Spirala kanalizacyjna  
 GB Drain auger  
 D Hand-Rohrreinigungsspirale  
 RUS Трос сантехнический для чистки труб

CZ Spirála kanalizační  
 RO Dispozitiv de desfundat scurgere  
 H Csőtisztító spirál  
 E Desatascador espiral



No.	Ø (mm)	L (m)	Box
55544	9	5	5/10
55545	9	10	4/8

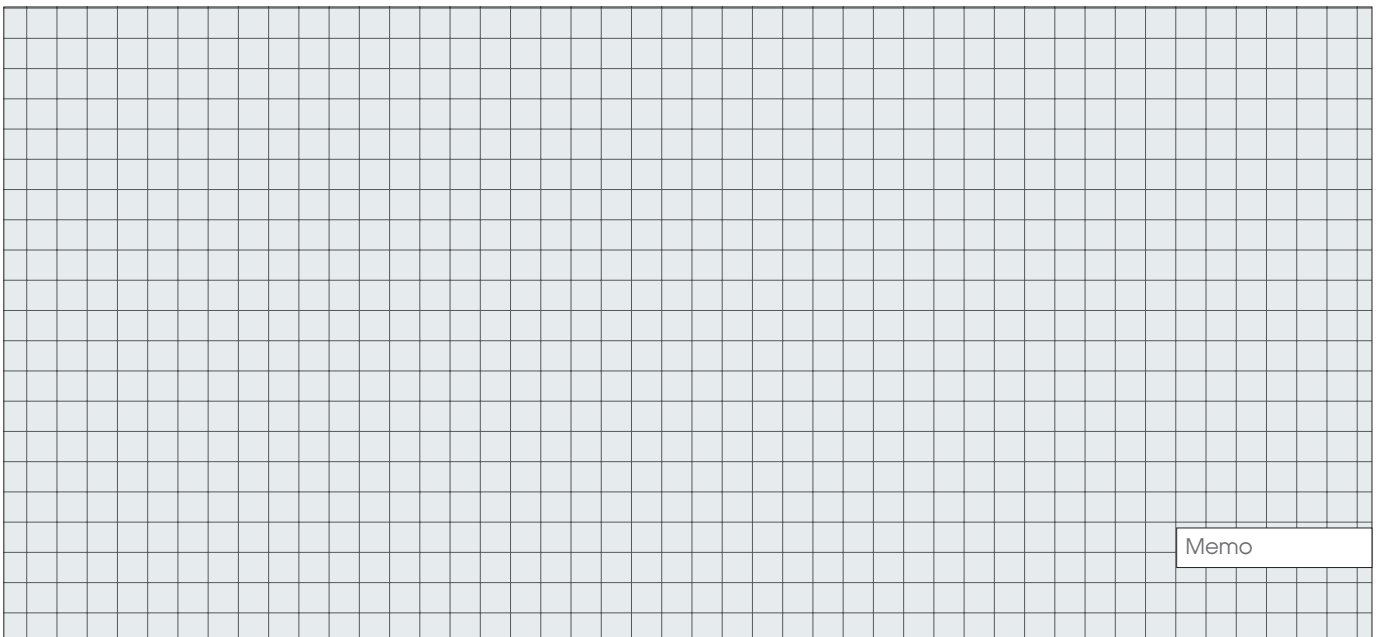

# 10

## Fastening tools Narzędzia do łączenia



**Hand riveters**  
 Nitownice ręczne

.....118-119

**Hand riveters**  
 Nitownice ręczne..... 118

**Hand riveting tool**  
 Nitownice ręczne, dźwigniowe..... 119

**Rivets**  
 Nity

.....119

**Aluminium blind rivets**  
 Nity aluminiowe..... 119

**Profile connection pliers**  
 Szczypce do łączenia profili

.....119

**Staple guns & staples**  
 Zszywacze i zszywki

.....119-120

**Staple guns**  
 Zszywacze..... 119

**Staples**  
 Zszywki..... 120

**Caulking guns**  
 Wyciskacze do mas

.....120-121

**Foam guns**  
 Pistolety do pianki montażowej

.....121

**Hose clips**  
 Opaski ślimakowe

.....121-123

**Cable ties**  
 Opaski plastikowe

.....123

**Glue sticks**  
 Wkłady klejowe

.....123

**Packing tape dispensers**  
 Podajniki taśmy pakowej

.....123

**Tapes**  
 Taśmy

.....124-126

**Ropes & lines**  
 Sznury i linki

.....126-128



PL Nitownica ręczna  
GB Hand riveter  
D Blindnietzange  
RUS Заклепочник

CZ Ruční nýtovačka  
RO Presă de nituit manuală  
H Kézi popszegecshúzó  
E Remachadora de mano



No.	L (mm)	Ø (mm)	Icon
70000	250	2.4; 3.2; 4.0; 4.8	12/24

PL Nitownica ręczna  
GB Hand riveter  
D Blindnietzange  
RUS Заклепочник

CZ Ruční nýtovačka  
RO Presă de nituit manuală  
H Kézi popszegecshúzó  
E Remachadora de mano



No.	L (mm)	Ø (mm)	Icon
70023	250	2.4; 3.2; 4.0; 4.8	12/24

PL Nitownica ręczna  
GB Hand riveter  
D Blindnietzange  
RUS Заклепочник

CZ Ruční nýtovačka  
RO Presă de nituit manuală  
H Kézi popszegecshúzó  
E Remachadora de mano



No.	L (mm)	Ø (mm)	Icon
70050	250	2.4; 3.2; 4.0; 4.8	12/24

PL Nitownica ręczna  
GB Hand riveter  
D Blindnietzange  
RUS Заклепочник

CZ Ruční nýtovačka  
RO Presă de nituit manuală  
H Kézi popszegecshúzó  
E Remachadora de mano



No.	Ø (mm)	Icon
70150	2.4; 3.2; 4.0; 4.8	12/24

PL Nitownica ręczna  
GB Hand riveter  
D Blindnietzange  
RUS Заклепочник

CZ Ruční nýtovačka  
RO Presă de nituit manuală  
H Kézi popszegecshúzó  
E Remachadora de mano



No.	L (mm)	Ø (mm)	Icon
70020	240	2.4; 3.2; 4.0; 4.8	12/24

PL Nitownica ręczna  
GB Hand riveter  
D Blindnietzange  
RUS Заклепочник

CZ Ruční nýtovačka  
RO Presă de nituit manuală  
H Kézi popszegecshúzó  
E Remachadora de mano



No.	L (mm)	Ø (mm)	Icon
70030	230	2.4; 3.2; 4.0; 4.8	15/30

PL Nitownica ręczna  
GB Hand riveter  
D Blindnietzange  
RUS Заклепочник

CZ Ruční nýtovačka  
RO Presă de nituit manuală  
H Kézi popszegecshúzó  
E Remachadora de mano

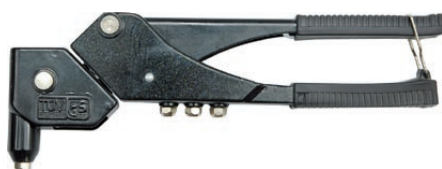

No.	L (mm)	Ø (mm)	Icon
70100	280	2.4; 3.2; 4.0; 4.8	12/24

PL Nitownica ręczna  
GB Hand riveter  
D Blindnietzange  
RUS Заклепочник

CZ Ruční nýtovačka  
RO Presă de nituit manuală  
H Kézi popszegecshúzó  
E Remachadora de mano



No.	L (mm)	Ø (mm)	Icon
70160	250	2.4; 3.2; 4.0; 4.8	12/24



PL Nitownica ręczna do nitonakrętek  
GB Hand nut tool  
D Blindnietzange  
RUS Заклепочник

CZ Nýtovačka páková  
RO Pclește pt. popnituri  
H Emeltyűs popszegecshűző  
E Remachadora de palanca

265 mm



VOREL

x4

No.	L (mm)	size / rozmiar	
70270	265	M3; M4; M5; M6	5/20

PL Nitownica dźwigniowa  
GB Hand riveting tool  
D Blindnietzange  
RUS Заклепочник

CZ Nýtovačka páková  
RO Pclește pt. popnituri  
H Emeltyűs popszegecshűző  
E Remachadora de palanca

470 mm



VOREL

No.	L (mm)	Ø (mm)	
70200	470	2.4; 3.2; 4.0; 4.8	10

PL Nity aluminiowe  
GB Aluminium blind rivets  
D Aluminiumblindnieten  
RUS Заклёпки алюминиевые

CZ Hliníkové nity  
RO Nituri din aluminiu  
H Alu popszegecs  
E Remaches de aluminio

50 PCS



VOREL

No.	mm	pcs packing	
70320	6.4x3.2	50	25/250
70330	9.6x3.2	50	25/250
70340	12.7x3.2	50	25/250
70400	6.4x4.0	50	25/200
70410	9.6x4.0	50	25/200
70420	12.7x4.0	50	25/200
70430	19.0x4.0	50	25/200
70480	6.4x4.8	50	25/150
70490	9.6x4.8	50	25/150
70500	12.7x4.8	50	25/150
70510	19.0x4.8	50	25/150

PL Nitownica dźwigniowa  
GB Hand riveting tool  
D Blindnietzange  
RUS Заклепочник

CZ Nýtovačka páková  
RO Pclește pt. popnituri  
H Emeltyűs popszegecshűző  
E Remachadora de palanca

300 mm

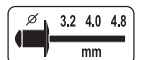

x3



VOREL

No.	L (mm)	Ø (mm)	
70201	300	3.2; 4.0; 4.8	20

PL Nitownica dźwigniowa  
GB Hand riveting tool  
D Blindnietzange  
RUS Заклепочник

CZ Nýtovačka páková  
RO Pclește pt. popnituri  
H Emeltyűs popszegecshűző  
E Remachadora de palanca

400 mm



VOREL

No.	L (mm)	Ø (mm)	
70210	400	3.4; 4.0; 4.8	12/24

PL Szczypce do łączenia profili  
GB Profile connection pliers  
D Zange zum Verbinden der Profile  
RUS Щипцы для соединения профилей

CZ Kleště ke spojování profilů  
RO Clește pt. îmbinarea profilelor  
H Profilgyesítő fogó  
E Pinzas para conectar perfiles

280 mm

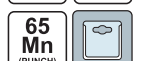

65 Mn (PUNCH)



VOREL

No.	L (mm)	
04300	280	6/36

PL Zszywacz tapicerski  
GB Staple gun  
D Tacker  
RUS Степлер мебельный  
пластиковый корпус

CZ Čalounická sešivačka  
RO Capsator tapiterie  
H Kárpitos tűzőgép  
E Grapadora de tapicero

4-8 mm



VOREL

No.	mm	
71000	4-8	10/60

PL Zszywacz tapicerski  
GB Staple gun  
D Tacker  
RUS Стеллер металлический с регулирующим винтом

CZ Čalounická sešivačka  
RO Capsator tapiterie  
H Kárpitos tűzőgép  
E Grapadora de tapicero

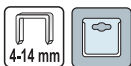

No.	mm	
71050	4-14	10/40

PL Zszywacz tapicerski  
GB Staple gun  
D Tacker  
RUS Стеллер

CZ Čalounická sešivačka  
RO Capsator tapiterie  
H Kárpitos tűzőgép  
E Grapadora de tapicero

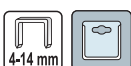

No.	mm	
71052	4-14	10/20

PL Zszywacz tapicerski  
GB Staple gun  
D Tacker  
RUS Стеллер

CZ Čalounická sešivačka  
RO Capsator tapiterie  
H Kárpitos tűzőgép  
E Grapadora de tapicero

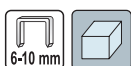

No.	mm	
71042	6-10	12/48

PL Wyciskacz do mas  
GB Caulking gun  
D Kartuschenpistole  
RUS Пистолет для герметика

CZ Protlačovač na hmoty  
RO Pistol silicon  
H Masszakinyomó  
E Pistola para masilla



No.	mm	
09100	230	20/40

PL Zszywacz tapicerski  
GB Staple gun  
D Tacker  
RUS Стеллер металлический

CZ Čalounická sešivačka  
RO Capsator tapiterie  
H Kárpitos tűzőgép  
E Grapadora de tapicero

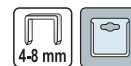

No.	mm	
71040	4-8	10/40

PL Zszywacz tapicerski  
GB Staple gun  
D Tacker  
RUS Стеллер

CZ Čalounická sešivačka  
RO Capsator tapiterie  
H Kárpitos tűzőgép  
E Grapadora de tapicero

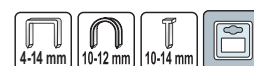

No.	
71060	6/24

PL Zszywki  
GB Staples  
D Heftklammern  
RUS Скобы

CZ Sešivky  
RO Capse tapiterie  
H Tűzőkapocs  
E Grapas

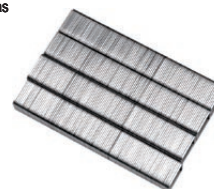

No.	mm	PCS packing	
72040	4	0.7x11.2	1000 60/480
72060	6	0.7x11.2	1000 60/360
72080	8	0.7x11.2	1000 60/300
72100	10	0.7x11.2	1000 60/240
72120	12	0.7x11.2	1000 50/200
72140	14	0.7x11.2	1000 40/160

PL Wyciskacz do mas  
GB Caulking gun  
D Kartuschenpistole  
RUS Пистолет для герметика

CZ Protlačovač na hmoty  
RO Pistol silicon  
H Masszakinyomó  
E Pistola para masilla



No.	mm	
09130	230	10/20

PL Wyciskacz do mas  
GB Caulking gun  
D Kartuschenpistole  
RUS Пистолет для герметика

CZ Protlačovač na hmoty  
RO Pistol silicon  
H Masszakinyomó  
E Pistola para masilla

230 mm



**VOREL**

No.	mm	
09150	230	20/40

PL Pistolet do pianki montażowej  
GB Foam gun  
D Farbspritz-pistole  
RUS Пистолет для монтажной пены

CZ Pistole na montážní pěnu  
RO Pistol spuma  
H Felrakó pisztoly, poliurethán habhoz  
E Pistola para espuma de montaje de metalo



**VOREL**

No.		
09170		10/20

PL Pistolet do pianki montażowej  
GB Foam gun  
D Farbspritz-pistole  
RUS Пистолет для монтажной пены

CZ Pistole na montážní pěnu  
RO Pistol spuma  
H Felrakó pisztoly, poliurethán habhoz  
E Pistola para espuma de montaje de metalo



**VOREL**

No.		
09172		10/20

PL Opaska ślimakowa  
GB Hose clip  
D Schlauchklemme  
RUS Хомут стальной

CZ Šneková páska  
RO Colier metalic  
H Csigapánt  
E Abrazadora



**DAGA**

No.	Ø (mm)	↑ mm	
73515	6-12	7.5	100
73516	8-14	7.5	100
73517	10-16	7.5	100
73521	12-20	9.0	100
73522	16-25	9.0	100
73523	20-32	9.0	100

PL Wyciskacz do mas  
GB Caulking gun  
D Kartuschenpistole  
RUS Пистолет для герметика

CZ Protlačovač na hmoty  
RO Pistol silicon  
H Masszakinyomó  
E Pistola para masilla

230 mm



**VOREL**

No.	mm	
09160	230	10/20

PL Pistolet do pianki montażowej  
GB Foam gun  
D Farbspritz-pistole  
RUS Пистолет для монтажной пены

CZ Pistole na montážní pěnu  
RO Pistol spuma  
H Felrakó pisztoly, poliurethán habhoz  
E Pistola para espuma de montaje de metalo



**VOREL**

No.		
09171		10/20

PL Pistolet do pianki montażowej  
GB Foam gun  
D Farbspritz-pistole  
RUS Пистолет для монтажной пены

CZ Pistole na montážní pěnu  
RO Pistol spuma  
H Felrakó pisztoly, poliurethán habhoz  
E Pistola para espuma de montaje de metalo



**VOREL**

No.		
09173		10/20

STAINLESS  
STEEL  
STAL  
NEROZŹYWA



No.	Ø (mm)	↑ mm	
73525	30-45	9.0	50
73527	40-60	9.0	50
73528	55-70	9.0	50
73529	65-80	9.0	50
73530	75-95	9.0	50
73532	90-110	9.0	50
73533	105-120	9.0	50
73534	115-130	9.0	50
73535	125-140	9.0	50
73536	145-160	9.0	50
73539	175-190	9.0	50
73540	190-205	9.0	50

- PL Opaska ślimakowa  
GB Hose clip  
D Schlauchklemme  
RUS Хомут стальной
- CZ Šneková páska  
RO Colier metalic  
H Csigapánt  
E Abrazadora



No.	Ø (mm)	pcs	box
73561	8-12	100	
73562	10-16	100	
73563	12-22	100	
73565	16-27	100	
73567	20-32	100	
73568	25-40	100	
73569	35-50	50	
73570	40-60	50	
73571	50-70	50	
73572	60-80	25	
73573	70-90	25	
73574	80-100	25	
73575	90-110	25	

- PL Komplet opasek ślimakowych  
GB Hose clip set  
D Schlauchklemmensatz  
RUS Набор хомутов
- CZ Sada šnekových pásek  
RO Set coliere metalice  
H Csigapántkészlet  
E Juego de abrazadoras



No.	pcs	box
73590	8	25

- PL Komplet serwisowy  
GB Hose clip set  
D Schlauchklemmensatz  
RUS Набор хомутов
- CZ Dělnická sada  
RO Set coliere metalice  
H Szervízkészlet  
E Juego de juntas



No.	pcs	box
73598	365	1

- PL Komplet opasek ślimakowych  
GB Hose clip set  
D Schlauchklemmensatz  
RUS Набор хомутов  
CZ Sada šnekových pásek  
RO Set coliere metalice  
H Csigapántkészlet  
E Juego de abrazadoras



No.	Ø (mm)	pcs	box
73836	25-40	2	40
73838	40-60	2	40

- PL Komplet opasek ślimakowych  
GB Hose clip set  
D Schlauchklemmensatz  
RUS Набор хомутов  
CZ Sada šnekových pásek  
RO Set coliere metalice  
H Csigapántkészlet  
E Juego de abrazadoras



No.	Ø (mm)	pcs	box
73831	8-12	4	4/40
73833	12-22	4	40
73835	20-32	4	40

- PL Opaska ślimakowa  
GB Hose clip  
D Schlauchklemme  
RUS Хомут стальной
- CZ Šneková páska  
RO Colier metalic  
H Csigapánt  
E Abrazadora



No.	Ø (mm)	pcs	box
73612	6-12	100	
73614	8-14	100	
73616	10-16	100	
73620	12-20	100	
73621	14-20	100	
73625	16-25	100	
73627	18-27	100	
73632	20-32	100	
73640	25-40	100	
73645	35-50	50	
73660	40-60	50	
73670	55-70	50	
73680	65-80	50	
73695	75-95	50	
73700	80-100	50	
73710	90-110	50	
73720	105-120	50	
73730	115-130	50	
73740	125-140	50	
73775	160-175	50	
73820	205-220	50	

PL Opaska ślimakowa do węży  
GB Hose clip  
D Schlauchklemme  
RUS Хомуты для шлангов

CZ Šňeková páska  
RO Colier metalic  
H Csígapánt  
E Abrazadora



No.	Ø (mm)	for hose / do węży Ø	pcs	
73506	12-20	1/2" (12.5 mm)	4	20
73507	16-25	3/4" (19.0 mm)	4	10/20
73508	20-32	1" (25.0 mm)	4	20
73510	12-20	1/2" (12.5 mm)	4	20
	16-25	3/4" (19.0 mm)		
73511	16-25	3/4" (19.0 mm)	4	20
	20-32	1" (25.0 mm)		

PL Wkłady klejowe  
GB Glue sticks  
D Heissklebpatronen  
RUS Тубы для клеевого пистолета

CZ Lepicí vložky  
RO Articole plastic (pt. pistol lipit)  
H Ragasztóbetét  
E Cartucho de cola



No.	mm	kg	
73300	11x200	1	10

PL Wkłady klejowe  
GB Glue sticks  
D Heissklebpatronen  
RUS Тубы для клеевого пистолета

CZ Lepicí vložky  
RO Articole plastic (pt. pistol lipit)  
H Ragasztóbetét  
E Cartucho de cola



No.	mm	pcs	
73260	7x100	12	50/200
73270	11x100	6	20/120
73271	11x150	12	20/60

PL Opaski plastikowe  
GB Cable ties  
D Kabelbinder  
RUS Хомуты-стяжки пластиковые

CZ Plastiková páska  
RO Set coliere din plastic  
H Műanyag pánt  
E Abrazadoras de plástico

PA 6.6 UL P4V2



No.	mm	max tensile strength / max odporność na zrywanie (kg)	wire bundle max Ø / max Ø wiązki kabli (mm)	pcs packing	
73891	80x2.5	8	15	100	250/500
73892	100x2.5	8	20	100	250/500
73893	150x2.5	8	40	100	250/500
73894	200x2.5	8	50	100	125/250
73895	300x3.6	18	80	100	75/150
73929	280x4.8	22	80	100	50/100
73896	370x4.8	22	100	100	50/100
73897	430x4.8	22	120	100	35/70
73898	500x8.0	54	130	50	30/60

PL Opaski plastikowe  
GB Cable ties  
D Kabelbinder  
RUS Хомуты-стяжки пластиковые

CZ Plastiková páska  
RO Set coliere din plastic  
H Műanyag pánt  
E Abrazadoras de plástico

PA 6.6 UL P4V2



No.	mm	max tensile strength / max odporność na zrywanie (kg)	wire bundle max Ø / max Ø wiązki kabli (mm)	pcs packing	
73881	80x2.5	8	15	100	250/500
73882	100x2.5	8	20	100	250/500
73883	150x2.5	8	40	100	250/500
73884	200x2.5	8	50	100	125/250
73885	300x3.6	18	80	100	75/150
73906	200x4.8	22	50	100	75/150
73909	280x4.8	22	80	100	50/100
73886	370x4.8	22	100	100	50/100
73887	430x4.8	22	120	100	35/70
73888	500x8.0	54	130	50	30/60

PL Podajnik taśmy pakowej  
GB Packing tape dispenser  
D Verpackungsband-Abroller  
RUS Диспенсер для клейких лент

CZ Páskovačka  
RO Pistol cu banda de impachetare  
H Csomagolószalag tépő  
E Precindadora de plástico



No.	W (mm)	
75295	50	12/24

- PL Taśma pakowa brązowa
- GB Packing tape, brown
- D Verpackungsband aus PP, braun
- RUS Упаковочная клейкая лента
- CZ Balící páska PP hnědá
- RO Bandă ambalare PP maro
- H PP barna ragasztószalag
- E Cinta de embalaje PP marrón



No.	W (mm)	L (m)	
75301	48	40	72
75302	48	66	36

- PL Taśma pakowa
- CZ Balící páska
- GB Packing tape
- RO Banda scotch
- D Band
- H Csomagolószalag
- RUS Упаковочная клейкая лента
- E Cinta de embalaje



No.	W (mm)	L (m)	
75300	48	45	12/120

- PL Taśma maskująca, niebieska
- GB Blue masking tape
- D Malerei blau Tape
- RUS Малярная стрічка
- CZ Maskovací páska
- RO Bandă de mascare
- H Fedőszalag
- E Cinta de enmascarar



No.	W (mm)	L (m)	
75120	30	25	40
75121	38	25	24
75122	48	25	24
75123	30	50	40
75124	38	50	24
75125	48	50	24

- PL Taśma pakowa przezroczysta
- GB Packing tape, transparent
- D Verpackungsband aus PP, durchsichtig
- RUS Упаковочная клейкая лента
- CZ Balící páska PP průhledná
- RO Bandă ambalare PP transparentă
- H Áttátszó ragasztószalag
- E Cinta de embalaje PP transparente



No.	W (mm)	L (m)	
75303	48	40	72
75304	48	66	36

- PL Taśma papierowa samoprzylepna
- GB Self adhesive paper tape
- D Papierband selbstklebend
- RUS Лента малярная бумажная
- CZ Páska papírová samolepicí
- RO Banda adeziva hartie
- H Ontapadó papírszalag
- E Cinta de papel adhesiva

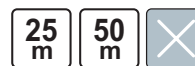

No.	W (mm)	L (m)	
75270	19	25	12/48
75271	25	25	36
75272	30	25	10/40
75273	38	25	6/24
75274	48	25	6/24
75285	25	50	9/36
75286	30	50	10/40
75287	38	50	6/24
75288	48	50	6/24

- PL Taśma tynkarska elewacyjna
- GB Plastering tape
- D Putzband
- RUS Штукатурные лента
- CZ Fasádní omítková páska
- RO Banda mascare pt. tencuieli
- H Homlokzati festő szalag
- E Cinta de escayola



No.	W (mm)	L (m)	
75130	38	20	24
75131	48	20	24
75132	38	50	28
75133	48	50	24

- PL Taśma dwustronna do wykładzin  
 GB Double-sided carpet tape  
 D Doppelseitiges Klebeband für Auslegware  
 RUS Двухсторонняя клейкая лента для укладки ковровых покрытий  
 CZ Obojstranná lepicí páska (na podlahové krytiny)  
 RO Bandă cu două părți adezive pt. mochete  
 H Kétoldalas szalag szőnyegpadlókhöz  
 E Cinta doble cara para alfombras



**VOREL**

No.	W (mm)	L (m)	
75260	50	5	48
75261	50	10	36
75262	50	25	24

- PL Taśma samoprzylepna dwustronna  
 GB Mounting tape  
 D Doppelseitiges montageband  
 RUS Двухсторонняя монтажная лента  
 CZ Páska montážní dvouvrstvá  
 RO Scotch cu banda dubla  
 H Kétoldalas ragasztószalag  
 E Cinta adhesiva, ambos lados

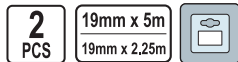

**VOREL**

No.	W (mm)	L (m)	
75100	19	2.25/5	12/96

- PL Taśma ostrzegawcza  
 GB Warning tape  
 D Warnband, Kleband  
 RUS Лента сигнальная  
 CZ Lepicí páska výstražná  
 RO Bandă adezivă avertizare  
 H Figyelmeztető ragasztó szalag  
 E Cinta adhesiva de advertencia

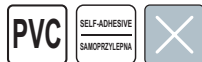

**VOREL**

No.	W (mm)	L (m)	
75231	48	33	24

- PL Taśma ostrzegawcza dwukolorowa  
 GB Two-colour warning tape  
 D Zweifarbiges Warnband  
 RUS Лента сигнальная  
 CZ Páska výstražná dvojbarevná  
 RO Banda de avertizare bicoloră  
 H Kétszínű jelzőszalag  
 E Cinta de advertencia bicolor



No.	W (mm)	L (m)	
75233	75	100	24

- PL Taśma dwustronna na folii  
 GB Double-sided tape  
 D Doppelseitiges Band auf PP-Folie  
 RUS Клейкая лента двухсторонняя на полипропиленовой основе  
 CZ Obojstranná páska na PP folii  
 RO Bandă cu două fețe pt. folii  
 H Kétoldalas  
 E Cinta doble cara sobre la base de PP



**VOREL**

No.	W (mm)	L (m)	
75245	50	5	72
75246	50	10	72
75247	50	25	36

- PL Taśma tekstylna „DUCT”  
 GB „DUCT” tape  
 D Textilband „DUCT”  
 RUS Лента армированная на тканевой основе

- CZ Textilní páska „DUCT”  
 RO Bandă textilă „DUCT”  
 H „DUCT” textil szalag  
 E Cinta textil „DUCT”



**VOREL**

No.	W (mm)	L (m)	
75238	48	10	36
75239	38	50	32
75240	48	50	24

- PL Taśma ostrzegawcza  
 GB Warning tape  
 D Warnband, kleband  
 RUS Лента сигнальная  
 CZ Lepicí páska výstražná  
 RO Bandă adezivă avertizare  
 H Figyelmeztető ragasztó szalag  
 E Cinta adhesiva de advertencia

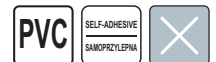

**VOREL**

No.	W (mm)	L (m)	
75230	48	33	24

- PL Taśma aluminiowa  
 GB Aluminium tape  
 D Aluminiumband  
 RUS Алюминиевая клейкая лента  
 CZ Hliníková páska  
 RO Bandă aluminiu  
 H Alumínium szalag  
 E Cinta de aluminio



**VOREL**

No.	W (mm)	L (m)	
75140	48	10	36
75141	48	50	24

- PL Taśma PCV  
GB PVC Tape  
D PVC Band  
RUS Изолента ПВХ
- CZ Páska PVC  
RO Banda izolatoare PVC  
H PVC Szalag  
E Cinta PVC



No.	W (mm)	thickness / grubość (mm)	L (m)	pcs. packing	
75000	19	0.13	10	10	50
75050	50	0.13	10	1	25/100

- PL Zestaw taśm izolacyjnych PCV  
GB Set of PVC insulating tapes  
D Satz von PVC-Isolierbändern  
RUS Изолента цветная

- CZ Sada izolačních pásek PVC  
RO Set de benzi de izolare din PVC  
H PVC szigetelő szalag készlet  
E Juego de cintas aislantes PVC



No.	W (mm)	thickness / grubość (mm)	L (m)	pcs. packing	
75012	15	0.13	10	10	50
75028	19	0.13	20	10	25

- PL Taśma samowulkanizująca  
GB Self-vulcanization tape  
D Selbstvulkanisierendes Band  
RUS Самовулканизирующаяся лента

- CZ Páska samovulkanizační  
RO Banda autovulcanizanta  
H Önvulkanizáló szalag  
E Cinta autovulcanizadora



No.	W (mm)	thickness / grubość (mm)	L (m)	
75035	19	0.8	10	60
75036	25	0.8	5	60

- PL Sznurek murarski  
GB Builders line  
D Maurerschnur  
RUS Шнур каменщика

- CZ Šňůra zednická  
RO Sfoară pt. zidari  
H Kőműves zsinór  
E Cuerda de albañil



No.	L (m)	colour / kolor	
17488	50		60
17489	100		60

- PL Taśma PCV  
GB PVC Tape  
D PVC Band  
RUS Изолента цветная
- CZ Páska PVC  
RO Banda izolatoare PVC  
H PVC Szalag  
E Cinta PVC

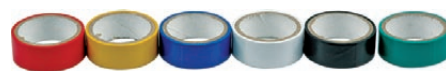

No.	W (mm)	thickness / grubość (mm)	L (m)	pcs. packing	
75060	19	0.13	3	6	10/100

- PL Taśma PCV do użytku zewnętrznego  
GB PVC tape  
D PVC Band  
RUS Лента ПВХ для внешних работ

- CZ Páska PVC  
RO Bandă PVC  
H Kétoldalas PVC  
E Cinta PVC



No.	W (mm)	L (m)	
75031	48	33	50

- PL Sznurek murarski  
GB Builders line  
D Maurerschnur  
RUS Шнур каменщика

- CZ Šňůra zednická  
RO Sfoară pt. zidari  
H Kőműves zsinór  
E Cuerda de albañil



No.	L (m)	
17495	75	12/48

- PL Sznurek murarski  
GB Builders line  
D Maurerschnur  
RUS Шнур - причалка

- CZ Šňůra zednická  
RO Sfoară pt. zidari  
H Kőműves zsinór  
E Cuerda de albañil



No.	L (m)	
17490	40	80



PL Linka pleciona polipropylenowa  
GB Polypropylene sennit line  
D Geflochtenes Seil aus Polypropylen  
RUS Канат полипропиленовый плетеный

CZ Lano pletené polypropylenové  
RO Coarda împletita din polipropilena  
H Polipropilén fonott kötél  
E Cuerda trenzada de polipropileno



**VOREL**

No.	Ø (mm)	L (m)	
69502	4	400	4
69503	5	250	4
69504	6	250	4
69505	8	300	2
69506	10	200	2
69493	12	20	15
69507	12	180	1
69508	14	110	1
69509	16	80	1
69510	18	70	1

PL Linka pleciona polipropylenowa  
GB Polypropylene sennit line  
D Geflochtenes Seil aus Polypropylen  
RUS Канат полипропилен

CZ Lano pletené polypropylenové  
RO Coarda împletita din polipropilena  
H Polipropilén fonott kötél  
E Cuerda trenzada de polipropileno



**VOREL**

No.	Ø (mm)	L (m)	
69521	4	20	50

PL Lina jutowa skręcana  
GB String jute rope  
D Verdrihtt seil aus Jute  
RUS Канат джутовый

CZ Lano jutová kroucená  
RO Cablu răsucit de iuta  
H Juta sodrott kötél  
E Cable de yute torcido



**VOREL**

No.	Ø (mm)	L (m)	
69572	10	10	40
69602	40	20	1

PL Sznurek murarski, polipropylenowy  
GB Polypropylene bricklayer's string  
D Maurerschnur aus Polypropylen  
RUS Шнур каменщика

CZ Šňůra zednická polypropylenová  
RO Șnur de zidărie din polietilena  
H Kőműves zsinór, polipropilén  
E Cordel de albañilería



**VOREL**

No.	Ø (mm)	L (m)	
17470	1.7	50	60/240
17471	1.7	100	30/120
17473	2.0	50	60/240
17474	2.0	100	30/120

PL Sznurek murarski polietylenowy  
GB Polyethylene bricklayer's string  
D Maurerschnur aus Polyäthylen  
RUS Полиэтиленовый шнур каменщика

CZ Šňůra zednická polyetylenová  
RO Șnur de zidărie din polietilena  
H Kőműves zsinór, polietilén  
E Cordel de albañilería de polietileno



**VOREL**

No.	Ø (mm)	L (m)	
17480	1.7	50	60/240
17481	1.7	100	30/120
17483	2.0	50	60/240
17484	2.0	100	30/120

PL Sznurek PP pleciony, uniwersalny  
GB Universal PP sennit string  
D PP-Schnur, geflochten, universell  
RUS Шнур полипропиленовый

CZ Šňůra PP pletená univerzální  
RO Șnur PP împletit, universal  
H PP fonott kötél, univerzális  
E Cordel trenzado universal PP



**VOREL**

No.	Ø (mm)	L (m)	
69620	3	10	50
69621	3	20	40

PL Sznurek pakowy, jutowy  
GB Packing jute string  
D Packschnur, aus Jute  
RUS Шнур джутовый

CZ Šňůra ucpávková jutová  
RO Șnur de împachetat, de iuta  
H Csomagkötöző spárga, juta  
E Cordel de yute para embalaje



**VOREL**

No.	dkg	
69630	5	112
69631	10	100

- PL Nici lniane, dratwa  
 GB Flax thread, twine  
 D Leinenfaden, Pechfaden  
 RUS Нить (дратва) льняная
- CZ Níť lněná, drátek  
 RO Fire de in, fire  
 H Len céma, fonál  
 E Hilo de lino, cabo de zapatero



No.	dkg	
69635	10	28
69637	25	18

- PL Linka pleciona, elastyczna  
 GB Elastic sennit line  
 D Geflochtenes Seil, elastisch  
 RUS Канат плетеный эластичный
- CZ Lano pletené elastické  
 RO Coarda împletită, elastică  
 H Fonott kötél, rugalmas  
 E Cuerda trenzada elástica

RUBBER CORE  
 GUMOWY RDZEŃ



No.	Ø (mm)	L (m)	
69550	6	150	1
69551	8	100	1
69552	10	100	1

10

- PL Lina igłowa  
 GB Needle rope  
 D Nadelseil  
 RUS Канат полипропиленовый, плетеный
- CZ Lano s jádrem opletené  
 RO Cablu ac  
 H Tűfonatos kötél  
 E Cable acalabrotado



No.	Ø (mm)	L (m)	
69539	8	10	30
69540	8	20	20
69542	10	10	25
69543	10	20	15
69546	12	20	10

- PL Sznurek PP do podwiązywania wełny izolacyjnej  
 GB Spliced wire polypropylene string  
 D Polypropylen erntegar  
 RUS Шнур полипропиленовый
- CZ Provázek polypropylenový  
 RO Snur din polipropilena  
 H Špagát polypropylénový  
 E Cuerda



No.	Ø (mm)	L (m)	
69608	2.5	200	100
69609	2.5	300	80
69610	2.5	450	50
69612	2.5	1000	24
69613	2.5	2000	12

Memo

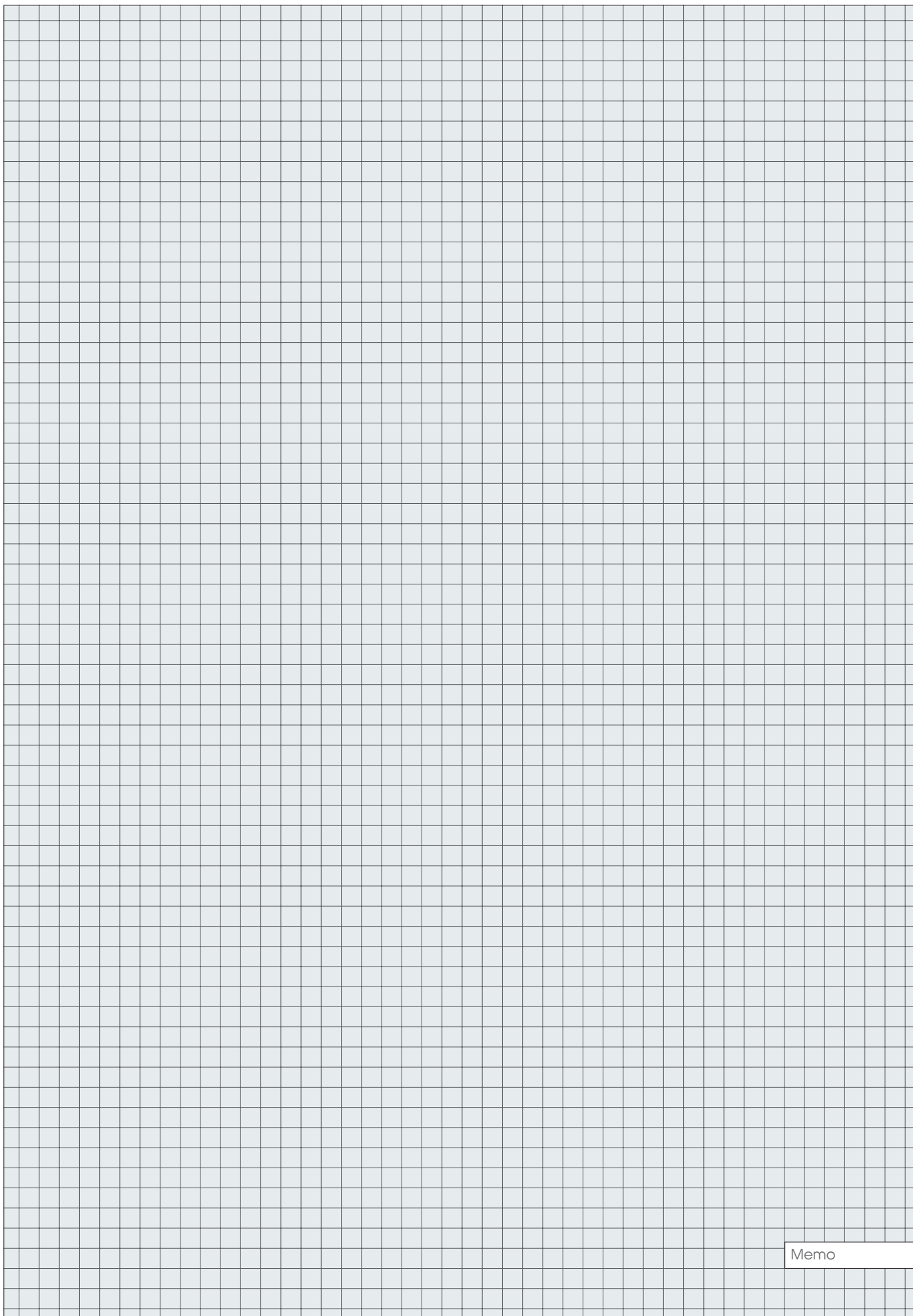

Memo

# 11

## Plastering & bricklaying tools Narzędzia budowlane i malarskie



**Tile cutters & accessories**  
**Przyrządy do cięcia glazury**  
**i akcesoria**

132-137

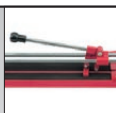
**Tile cutters**

Przyrządy do glazury..... 132

**Tile cutting pliers**

Szczypce do glazury..... 133

**Grout removers & finishers**

Skrobaki i szpachelki do fug..... 134

**Accessories for tiles**

Akcesoria do glazury..... 134

**Burners & soldering tools**  
**Palniki i lutownice**

137-138

**Gas burners & accessories**  
**Palniki gazowe i akcesoria**

138-140

**Ladders**  
**Drabiny**

140-141

**Masonry tools**  
**Narzędzia budowlane**

141-156

**Floats**

Pace..... 141

**Trowels**

Kielnie..... 143

**Tools for areated blocks**

Narzędzia do betonu komórkowego..... 143

**Scrapers**

Szpachelki..... 144

**Painting scrapers**

Skrobaki malarskie..... 146

**Mason's pans**

Czerpaki murarskie..... 146

**Building strainers**

Sita budowlane..... 146

**Paint mixers & grout mixers**

Mieszadła do farb i do zaprawy..... 147

**Paint rollers & accessories**

Wałki do malowania i akcesoria..... 148

**Paint brushes**

Pędzle malarskie..... 151

**Painting sheets**

Folie malarskie..... 152

**Painting suits**

Kombinezony malarskie..... 152

**Bags**

Worki..... 152

**Tapes**

Taśmy..... 153

**Plastic buckets & tubs**

Wiadra i kaski budowlane..... 155

**Suction lifters**

Uchwyty do szyb..... 155

**Hooks „Juco”**

Haki budowlane „Juco”..... 156

**Carpenter's pencils & accessories**

Ołówki stolarskie i akcesoria..... 156

**Benders**

Giętarki..... 156

PL Przyrząd do cięcia glazury  
GB Tile cutting machine  
D Fliesenschneidemaschine  
RUS Плиткорез

CZ Přístroj na řezání glazury  
RO Aparat de taiat faianța  
H Csempevágó  
E Cortadora de gres

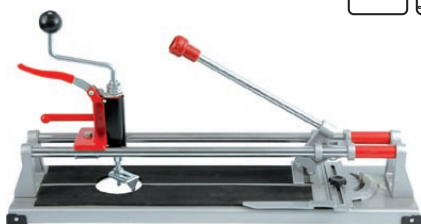
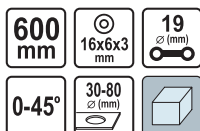

No.	mm	Ø (mm)	
00300	600	19	1

PL Przyrząd do cięcia glazury  
GB Tile cutting machine  
D Fliesenschneidemaschine  
RUS Плиткорез

CZ Přístroj na řezání glazury  
RO Aparat de taiat faianța  
H Csempevágó  
E Cortadora de gres

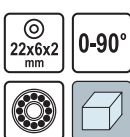

No.	mm	Ø (mm)	
00500	480	20	1
00600	580	20	1

PL Przyrząd do cięcia glazury  
GB Tile cutting machine  
D Fliesenschneidemaschine  
RUS Плиткорез

CZ Přístroj na řezání glazury  
RO Aparat de taiat faianța  
H Csempevágó  
E Cortadora de gres

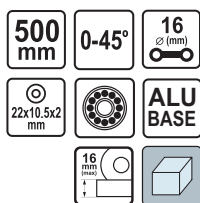

No.	mm	Ø (mm)	
00703	500	16	1

PL Przyrząd do cięcia glazury  
GB Tile cutting machine  
D Fliesenschneidemaschine  
RUS Плиткорез

CZ Přístroj na řezání glazury  
RO Aparat de taiat faianța  
H Csempevágó  
E Cortadora de gres

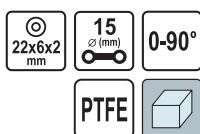

No.	mm	Ø (mm)	
01060	600	15	1

PL Przyrząd do cięcia glazury  
GB Tile cutting machine  
D Fliesenschneidemaschine  
RUS Плиткорез

CZ Přístroj na řezání glazury  
RO Aparat de taiat faianța  
H Csempevágó  
E Cortadora de gres

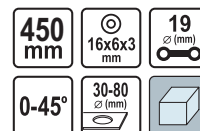

No.	mm	Ø (mm)	
00320	450	19	1

PL Przyrząd do cięcia glazury  
GB Tile cutting machine  
D Fliesenschneidemaschine  
RUS Плиткорез

CZ Přístroj na řezání glazury  
RO Aparat de taiat faianța  
H Csempevágó  
E Cortadora de gres

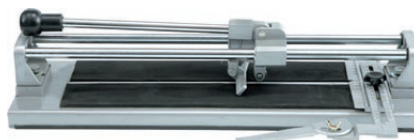
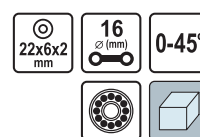

No.	mm	Ø (mm)	
00510	500	16	1
00610	590	16	1

PL Przyrząd do cięcia glazury  
GB Tile cutting machine  
D Fliesenschneidemaschine  
RUS Плиткорез

CZ Přístroj na řezání glazury  
RO Aparat de taiat faianța  
H Csempevágó  
E Cortadora de gres

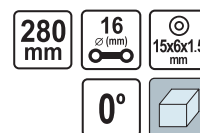

No.	mm	Ø (mm)	
02300	280	16	6

PL Przyrząd do cięcia glazury  
GB Tile cutting machine  
D Fliesenschneidemaschine  
RUS Плиткорез

CZ Přístroj na řezání glazury  
RO Aparat de taiat faianța  
H Csempevágó  
E Cortadora de gres

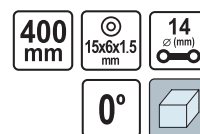

No.	mm	Ø (mm)	
02400	400	14	6

- PL Kółko wymienne ze śrubą  
 GB Tile cutting wheel  
 D Schneidrad mit schraube  
 RUS Запасной ролик для плиткореза
- CZ Výměnné kolečko se šroubem  
 RO Cutiț rola  
 H Cseregörgő csavarral  
 E Recambio de cuchillo redondo



No.	mm	for / dla	
03150	15x6x1.5	01400; 01500; 01600; 02300; 02400	50/200
03160	16x6x3	00300; 00310; 00320	50/200
03220	22x6x2	00400; 00410; 00500; 00510; 00600; 00610; 00700; 01040; 01050; 01060	50/200

- PL Szczypce do glazury  
 GB Tile cutting pliers  
 D Glasurzange  
 RUS Кусачки для плитки
- CZ Kleště do glazury  
 RO Clește rupt faianța  
 H Csempefogó  
 E Tenazas para azulejos



No.	L (mm)	mm	
04000	200	15	10/60

- PL Szczypce do cięcia glazury  
 GB Tile cutting pliers  
 D Glasurzange  
 RUS Кусачки для плитки
- CZ Kleště do glazury  
 RO Clește rupt faianța  
 H Csempefogó  
 E Tenazas para azulejos



No.	L (mm)	
04020	200	6/36

- PL Szczypce do glazury  
 GB Tile cutting nipper  
 D Glasurzange  
 RUS Клещи для плитки твердосплавные
- CZ Kleště do glazury jednoduché  
 RO Clește drept pt. glazură  
 H Egyenes csempé harapófogó  
 E Tenazas para azulejos recto



No.	L (mm)	
04200	200	12/60

- PL Kółko tnące wymienne  
 GB Tile cutting wheel  
 D Schneiderrad  
 RUS Запасной ролик для плиткореза
- CZ Výměnné kolečko  
 RO Cutiț rola  
 H Cseregörgő csavarral  
 E Recambio de cuchillo redondo



No.	mm	for / dla	
03221	22x10.5x2	00703	50/200

- PL Szczypce do cięcia i łamania glazury  
 GB Tile cutting pliers  
 D Glasurzange  
 RUS Кусачки для плитки
- CZ Kleště do glazury  
 RO Clește rupt faianța  
 H Csempefogó  
 E Tenazas para azulejos



No.	L (mm)	
04001	215	50

- PL Szczypce do łamania glazury  
 GB Tile cutting pliers  
 D Glasurzange  
 RUS Кусачки для плитки
- CZ Kleště do glazury  
 RO Clește rupt faianța  
 H Csempefogó  
 E Tenazas para azulejos



No.	L (mm)	
04022	200	6/60

- PL Obcęgi do glazury wygięte  
 GB Tile cutting nipper  
 D Glasurzange  
 RUS Клещи для плитки твердосплавные
- CZ Kleště do glazury ohnuté  
 RO Clește curbat pt. glazură  
 H Hajlított csempé harapófogó  
 E Tenazas para azulejos curvo



No.	L (mm)	
04210	200	12/60

PL Miotek glazuryczny z widiowym rysikiem  
 GB Tile hammer  
 D Fliesenhammer  
 RUS Молоток для облицовочной плитки, твердосплавный

CZ Kladívko na dlaždice  
 RO Ciocan pt. placi ceramice  
 H Csempézókalapács  
 E Martillo para azulejos



TCT



No.	mm	
04131	12x12	16/96

PL Skrobak do fug  
 GB Grout remover  
 D Fugenreiniger  
 RUS Скребок для швов кладки

CZ Škrabák na spáry  
 RO Răzuitoare pt. rosturi  
 H Fugakihúzó  
 E Rascador para juntas



No.		
04406		40/160

PL Szpachelka do fug  
 GB Grout finisher  
 D Fugenreiniger  
 RUS Шпатель для затирки межплиточных швов

CZ Šuves skrēpers  
 RO Răzuitoare pt. rosturi  
 H Fugakihúzó  
 E Rascador para juntas



No.		
04410		450

PL Piłka z brzeszczotem wolframowym  
 GB Tile saw  
 D Handsäge mit Wolfram-Sägedraht  
 RUS Пилка с карбид-вольфрамовым напылением

CZ Pilka na obklady a dlaždice  
 RO Fierăstrău pt. placi ceramice  
 H Fűrész csempéhez, kerámiahöz  
 E Sierra hilo carburo tungsteno

150 mm

6"

TCT



No.	size / rozmiar	
27540	6" (150 mm)	5/60

PL Skrobak do fug  
 GB Grout remover  
 D Fugenreiniger  
 RUS Скребок для швов плитки

CZ Škrabák na spáry  
 RO Spaclu pt. rosturi  
 H Fugakihúzó  
 E Rascador para juntas



No.		
04400		40/400

PL Skrobak do fug  
 GB Grout remover  
 D Fugenreiniger  
 RUS Скребок для швов плитки

CZ Škrabák na spáry  
 RO Răzuitoare pt. rosturi  
 H Fugakihúzó  
 E Rascador para juntas



No.		
04407		100

PL Skrobak do fug  
 GB Grout remover  
 D Fugenreiniger  
 RUS Скребок для швов плитки

CZ Škrabák na spáry  
 RO Spaclu pt. rosturi  
 H Fugakihúzó  
 E Rascador para juntas

TUNGSTEN CARBIDE  
 WEGLIK WOLFRAMU



No.	mm	
04405	50x2	12/60

PL Wycinarka do otworów w glazurze  
 GB Circular tile cutter  
 D Fliesenbohrzeug  
 RUS Резак по плитке  
 CZ Výseč otvorů v glazúře  
 RO Cútit rotativ taiat faianta  
 H Lyukkvágó csempéhez  
 E Ruleta de corte para azulejos

20-90  
 Ømm

TCT

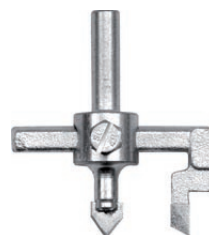

No.	Ø (mm)	
03900	20-90	80/160



- PL Wycinarka do otworów w glazurze  
 GB Circular tile cutter  
 D Fliesenbohrzeug  
 RUS Резак по плитке  
 CZ Výseč otvorů v glazuře  
 RO Cutit rotativ taiat faianta  
 H Lyukkivágó csempéhez  
 E Ruleta de corte para azulejos



No.	Ø (mm)	
03920	30-80	10/100

- PL Ostrze zapasowe do wycinarki 03940  
 GB Spare blades for 03940  
 D Schneide für 03940  
 RUS Запасные элементы для резака 03940
- CZ Náhradní soustava na vystřihovačku H03940  
 RO Lama rezerva pt. 03940  
 H Tartalékészlet a 03940 kivágóhoz  
 E Juego de recambios para ruleta 03940



No.	for / dla	
03950	03940	20/200

- PL Rysik do cięcia i łamania glazury  
 GB TC tile cutter and breaker  
 D Fliesengriffel und brecher  
 RUS Плиткорез-карандаш с отламывателем
- CZ Rýsovací jehla na řezání a lámání glazury  
 RO Cutit taiat / rupt faianta  
 H Kartú csempévágáshoz és töréshoz  
 E Cortador y rompedor de azulejos



No.	L (mm)	
04100	200	50/100

- PL Maskownica uniwersalna  
 GB Magnetic lock  
 D Universal verdeckung mit Magnet  
 RUS Замок магнитный для кафеля
- CZ Maskovací rám univerzální do glazury  
 RO Opritor magnetic  
 H Univerzális maszkoló csempéhez  
 E Cierre magnetico universal



No.		
04510		40

- PL Wycinarka do otworów w glazurze  
 GB Circular tile cutter  
 D Fliesenlochbohrer mit handschutz  
 RUS Резак по плитке „Балеринка” с защитной решеткой



No.	Ø (mm)	
03940	20-94	24

- PL Rysik do cięcia glazury  
 GB Hand tile cutter and breaker  
 D Fliesengriffel  
 RUS Резак для плитки
- CZ Rýsovací jehla na řezání glazury  
 RO Cutit taiat / rupt faianta  
 H Kartú csempévágáshoz  
 E Cortador de azulejos



No.	L (mm)	
04050	130	50/400

- PL Przyrząd do poziomowania płytek  
 GB Tile leveling set  
 D Schlagschnurgerät  
 RUS Уровень для укладки кафеля
- CZ Přístroj pro regulaci úrovně dlaždiček  
 RO Fir pt. trasat  
 H Padlólapszintező eszköz  
 E Nivelador de cuerda para azulejos

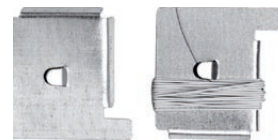

No.		
04500		60

- PL Gąbka glazuryczna  
 GB Glazing sponge  
 D Fliesenschwamm  
 RUS Губка для затирки плитки
- CZ Houba na spárování obkladů  
 RO Burete pt. plăci ceramice  
 H Csempézó szivacs  
 E Esponja para esmaltar



No.	mm	
04540	165x100x60	74

- PL Gąbka glazuryczna hydrochlonna  
 GB Hygroscopic glazing sponge  
 D Wasseraufsaugender Fliesenschwamm  
 RUS Губка для затирки плитки
- CZ Houbka na spárování obkladů nasávká  
 RO Burete pt. plăci ceramice hidroabsorbant  
 H Nedvszívó csempéző szivacs  
 E Esponja para esmalter higroscópica



No.	mm	
04542	170x110x60	56

- PL Gąbka glazuryczna gumowa  
 GB Rubber glazing sponge  
 D Gummi-Fliesenschwamm  
 RUS Губка для затирки плитки
- CZ Houbka na spárování obkladů gumová  
 RO Burete pt. plăci ceramice de cauciuc  
 H Gumi csempéző szivacs  
 E Esponja para esmalter de goma



No.	mm	
04546	150x100x50	10

- PL System poziomowania płytek  
 GB Tile leveling system  
 D Fliesen-Ausgleichssystem  
 RUS Система выравнивания плитки-зажим СВП  
 CZ Dlaždice nivelační systém  
 RO Sistemul de nivelare Placi  
 H Csempé szintező rendszer  
 E Sistema de nivelación del azulejo

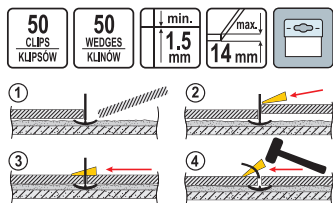

30x30	33x33	40x40	45x45	50x50	60x60	80x80	60x30	100x50	120x60
42	36	20	28	24	10	10	22	16	10

number of clips and wedges for various dimensions tiles per 1m<sup>2</sup> / Ilość klinów na 1m<sup>2</sup> w zależności od rozmiaru płytki:



No.	pcs	
04691	50+50	15

- PL Gąbka glazuryczna podwójna  
 GB Double glazing sponge  
 D Doppelter Fliesenschwamm  
 RUS Губка для затирки плитки
- CZ Houbka na spárování obkladů dvoustranná  
 RO Burete pt. plăci ceramice dublu  
 H Dupla csempéző szivacs  
 E Esponja para esmalter doble



No.	mm	
04544	165x100x80	18

- PL System poziomowania płytek  
 GB Tile leveling system  
 D Fliesen-Ausgleichssystem  
 RUS Система выравнивания плитки-зажим СВП  
 CZ Dlaždice nivelační systém  
 RO Sistemul de nivelare Placi  
 H Csempé szintező rendszer  
 E Sistema de nivelación del azulejo

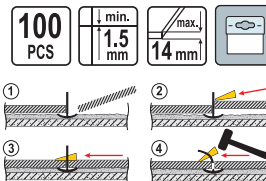

30x30	33x33	40x40	45x45	50x50	60x60	80x80	60x30	100x50	120x60
42	36	20	28	24	10	10	22	16	10

number of clips and wedges for various dimensions tiles per 1m<sup>2</sup> / Ilość klinów na 1m<sup>2</sup> w zależności od rozmiaru płytki:



No.	pcs	
04690	100	15

- PL System poziomowania płytek  
 GB Tile leveling system  
 D Fliesen-Ausgleichssystem  
 RUS Система выравнивания плитки-зажим СВП  
 CZ Dlaždice nivelační systém  
 RO Sistemul de nivelare Placi  
 H Csempé szintező rendszer  
 E Sistema de nivelación del azulejo

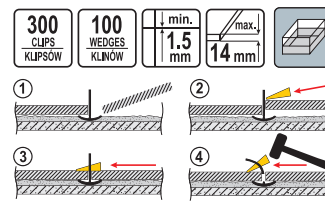

30x30	33x33	40x40	45x45	50x50	60x60	80x80	60x30	100x50	120x60
42	36	20	28	24	10	10	22	16	10

number of clips and wedges for various dimensions tiles per 1m<sup>2</sup> / Ilość klinów na 1m<sup>2</sup> w zależności od rozmiaru płytki:



No.	pcs	
04692	300+100	1

**PL** Klíny do glazury  
**GB** Wedges for wall and floor tiles  
**D** Keile für Wand und Bodenfliesen  
**RUS** Клинья для плитки

**CZ** Klíny do glazury  
**RO** Distanțiere faianța  
**H** Ék csempéhez  
**E** Cuñas para juntas de azulejos



No.	mm	pcs packing	📦
04700	23x4	100	100
04710	37x7	50	100

**PL** Krzyżyki dystansowe  
**GB** Cross shape tile spacers  
**D** Fliesenkreuze  
**RUS** Крестики для плитки

**CZ** Distanční křížky  
**RO** Distanțiere în cruce  
**H** Hézagoló kereszt  
**E** Crucetas para juntas



No.	mm	pcs packing	📦
04600	1.5	200	100
04610	2.0	200	100
04620	2.5	200	100
04630	3.0	150	100
04640	4.0	100	100
04650	5.0	100	100
04660	6.0	75	100
04668	8.0	30	100
04670	10.0	30	100

**PL** Gazowa lampa lutownicza  
**GB** Gas soldering lamp  
**D** Gaslötlampe  
**RUS** Газовая паяльная лампа

**CZ** Plynová pájecí lampa  
**RO** Lampă de lipit pe gaz  
**H** Gázos forrasztólámpa  
**E** Lampa de gas para soldar

**1200°C**  
max.  
**1.7**  
kW  
**123**  
g/h  
 CARTRIDGE  
**190g**  
**BUTAN**  
 COMPOSITE  
 BODY  
 PLASTIKOWY  
 KORPUS



No.	kW	📦
73400	1.7	12

**PL** Hak do usuwania krzyżków dystansowych  
**GB** Tile spacer remover  
**D** Fliesenkreuzentferner  
**RUS** Крючок для удаления крестиков

**CZ** Škrabka na čistění spár  
**RO** Dispozitiv pt. scos distantiere faianța  
**H** Fuga kiséző  
**E** Utensilio para quitar crucetas



No.	📦
04675	20/60

**PL** Klamry do paneli ściennych  
**GB** Panel clamps  
**D** Klammern für paneele  
**RUS** Крепеж для панелей

**CZ** Přichytky do panelů  
**RO** Cleme (bride) pt. panouri  
**H** Kapcsok c panelekhez  
**E** Abrazaderas para paneles de paredes

100  
PCS



No.	type	pcs packing	📦
04720	C-3	100	50
04721	C-1	100	50

**PL** Gazowa lampa lutownicza PIEZO  
**GB** Gas soldering lamp  
**D** Gaslötlampe  
**RUS** Лампа паяльная газовая с пьезоподжигом

**CZ** Plynová pájecí lampa  
**RO** Lampă de lipit pe gaz  
**H** Gázos forrasztólámpa  
**E** Lampa de gas para soldar

**PIEZO**  
ELECTRIC  
**1200°C**  
max.  
**1.7**  
kW  
**123**  
g/h  
 CARTRIDGE  
**190g**  
**BUTAN**

**METAL**  
COVER  
**METALOWY**  
KORPUS



No.	kW	📦
73403	1.7	12

PL Lutownica gazowa 3 w 1  
GB Soldering tool 3 in 1  
D Gaslötkolben 3 in 1  
RUS Газовый паяльник 3-в-1

CZ Plynova pajka 3 in 1  
RO Ciocan de lipit cu gaz 3 in 1  
H Gaz-forrasztópaka 3 in 1  
E Soldador de gas 3 in 1

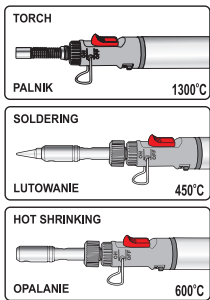

No.	73410	12/48
-----	-------	-------

PL Palnik gazowy  
GB Gas blow torch  
D Lötbrenner  
RUS Газовая горелка

CZ Plynový hořák  
RO Arzator pe gaz  
H Gázégő  
E Soplete de gas

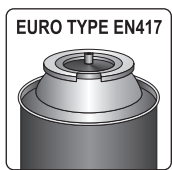
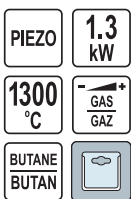

No.	73413	10/60
-----	-------	-------

PL Dysza do lutowania plomieni punktowy  
GB Point nozzle  
D Düse zum Löten, Punktflamme  
RUS Согло паяльника

CZ Dýza na letování, bodový plamen  
RO Duză pt. lipit, fiacără punct  
H Forrasztó égő, szűró láng  
E Tobera para soldadura, llama de punta



No.	73330	size / rozmiar (mm)	17	50/250
-----	-------	---------------------	----	--------

PL Palnik gazowy  
GB Gas blow torch  
D Lötbrenner  
RUS Газовая горелка

CZ Plynový hořák  
RO Arzator pe gaz  
H Gázégő  
E Soplete de gas

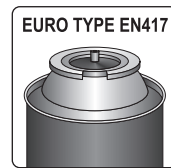
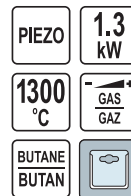

No.	73412	10/60
-----	-------	-------

PL Zestaw do lutowania z dyszami  
GB Plumbers torch set with burners  
D Lötsatz  
RUS Набор для пайки  
CZ Souprava k letování  
RO Set pt. lipit  
H Forrasztó készlet  
E Juego para soldadura

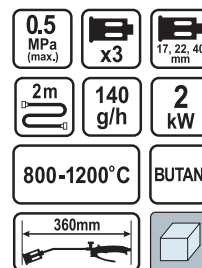

No.	73325	MPa (max)	0.5	kW	2	L (mm)	360	20
-----	-------	-----------	-----	----	---	--------	-----	----

PL Dysza do lutowania plomieni plaski  
GB Flat nozzle  
D Düse zum Löten, flache Flamme  
RUS Согло плоское

CZ Dýza na letování, plochý plamen  
RO Duză pt. lipit, fiacără plată  
H Forrasztó égő, lapos láng  
E Tobera para soldadura, llama plana



No.	73331	size / rozmiar (mm)	40	50/250
-----	-------	---------------------	----	--------

**PL** Dysza do lutowania plomieni otaczający  
**GB** Pipe nozzle  
**D** Düse zum Löten, Umgebungsflamme  
**RUS** Сопло паяльника, кольцевое

**CZ** Dýza na letování, prstencový plamen  
**RO** Duză pt. lipit, flacăra înconjurătoare  
**H** Forrasztó égő, körülölelő láng  
**E** Tobera para soldadura, llama envolvente



No.	size / rozmiar (mm)	Box
73332	22	50/250

**PL** Palnik dekarski z dyszą i lancą  
**GB** Roof heating torch with burners  
**D** Dachdeckerbrenner  
**RUS** Кровельная горелка  
**CZ** Hořák pro pokrývace  
**RO** Arzător pt. acoperiș  
**H** Bádogos forrasztó készülék  
**E** Soplete de techado

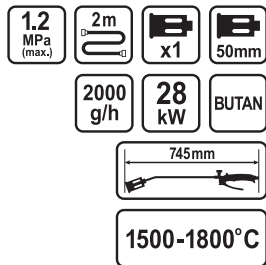

No.	MPa (max)	kW	L (mm)	Box
73341	1.2	28	745	20

**PL** Palnik dekarski z dyszami i lancą  
**GB** Roof heating torch with burners  
**D** Dachdeckerbrenner  
**RUS** Кровельная горелка  
**CZ** Hořák pro pokrývace  
**RO** Arzător pt. acoperiș  
**H** Bádogos forrasztó készülék  
**E** Soplete de techado

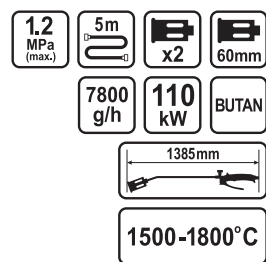

No.	MPa (max)	kW	L (mm)	Box
73343	1.2	110	1385	8

**PL** Palnik dekarski z dyszami  
**GB** Roof heating torch with burners  
**D** Dachdeckerbrenner  
**RUS** Кровельная горелка  
**CZ** Hořák pro pokrývace  
**RO** Arzător pt. acoperiș  
**H** Bádogos forrasztó készülék  
**E** Soplete de techado

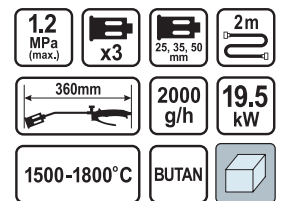

No.	MPa (max)	kW	L (mm)	Box
73340	1.2	19.5	360	10

**PL** Palnik dekarski z dyszą i lancą  
**GB** Roof heating torch with burners  
**D** Dachdeckerbrenner  
**RUS** Кровельная горелка  
**CZ** Hořák pro pokrývace  
**RO** Arzător pt. acoperiș  
**H** Bádogos forrasztó készülék  
**E** Soplete de techado

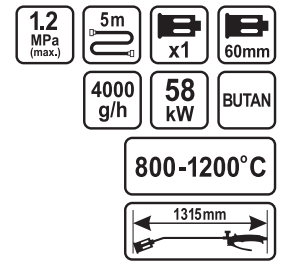

No.	MPa (max)	kW	L (mm)	Box
73342	1.2	58	1315	8

**PL** Palnik dekarski z dyszami i lancą  
**GB** Roof heating torch with burners  
**D** Dachdeckerbrenner  
**RUS** Кровельная горелка  
**CZ** Hořák pro pokrývace  
**RO** Arzător pt. acoperiș  
**H** Bádogos forrasztó készülék  
**E** Soplete de techado

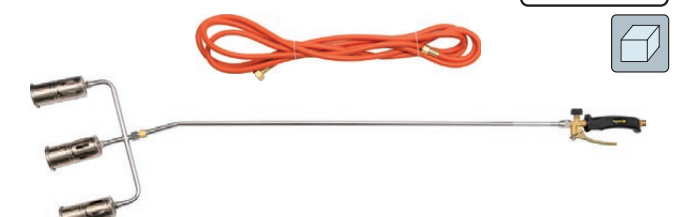
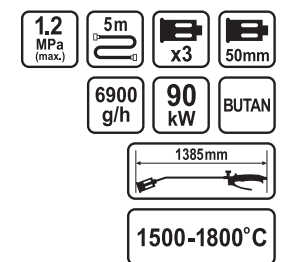

No.	MPa (max)	kW	L (mm)	Box
73344	1.2	90	1385	8

- PL Dysza  
GB Nozzle  
D Düse  
RUS Конно
- CZ Dýza  
RO Duză  
H Fúvóka  
E Tobera



No.	Ø (mm)	☐
73350	25	25/50
73351	35	25/50
73352	50	25/50
73353	60	25/50

- PL Drabina wielofunkcyjna  
GB Multifold ladder  
D Mehrzweckleiter  
RUS Многофункциональная стремянка

- CZ Multifunkční žebřík  
RO Scară multifuncțională  
H Többcéltű létra  
E Escalera multipropósito

3.8 m max  
STEPS STOPNIE x13  
Al NYLON  
max 150 kg

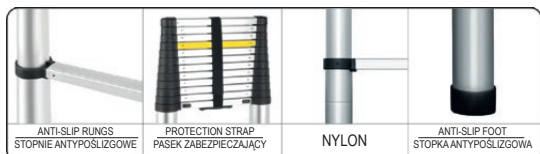
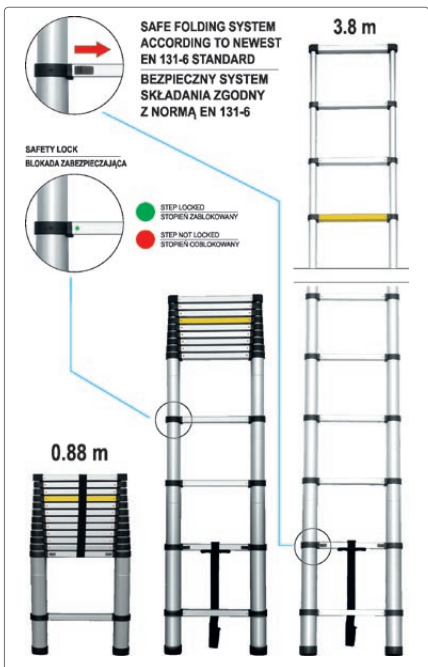

No.	☐
17701	1

- PL Waż przyłączeniowy do gazu  
GB Hose  
D Anschlussschlauch für Gas  
RUS Шланг газоподводящий

- CZ Hadice k připojení plynu  
RO Furtun de conectare pt. gaz  
H Csatlakozó gáztömlő  
E Manguera de conexión de gas



No.	L (m)	Ø (mm)	☐
73360	2	8	40
73362	5	8	20

- PL Drabina wielofunkcyjna  
GB Multifold ladder  
D Mehrzweckleiter  
RUS Лестница многофункциональная  
CZ Multifunkční žebřík  
RO Scară multifuncțională  
H Többcéltű létra  
E Escalera multipropósito

3.4 m max  
STEPS STOPNIE 4x3  
16 kg  
max 150 kg

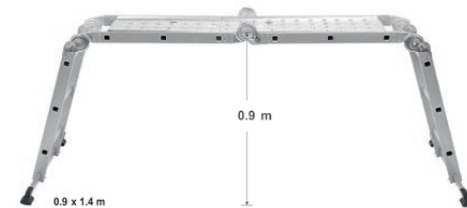

No.	☐
17704	1

- PL Podest do drabiny wielofunkcyjnej  
 GB Multifunction ladder platform  
 D Podest für die Multifunktionale Leiter  
 RUS Подставки для стремянки  
 CZ Plošina pro víceúčelový žebřík  
 RO Platformă pt. scară multifuncțională  
 H Palló a multifunkciós létrához  
 E Descansillos para la escala multifuncional



No.	for / dla	☐
17705	17704	5

- PL Paca styropianowa  
 GB Polystyrene plastering trowel  
 D Styropor-reibebrett  
 RUS Тёрка пенопластовая
- CZ Polystyrénové hladítko  
 RO Gletiera poliuretan  
 H Habszivacs simító  
 E Llana de polietileno



No.	mm	☐
06420	140x700	10
06430	140x1000	10

- PL Tarka do styropianu  
 GB Steel plastering trowel  
 D Reibebrett für Styropor  
 RUS Тёрка стальная нержавеющая
- CZ Ohnutá špachtle nerezavějící  
 RO Gletiera otel  
 H Spatula hajlított, rozsdamentes  
 E Espatula de acero inox curvo



No.	mm	☐
06470	270x130	20
06472	350x160	15

- PL Paca tynkarska filc  
 GB Plastering trowel  
 D Filzgläter  
 RUS Тёрка пластмассовая с войлочным покрытием  
 CZ Umělohmotné hladítko omítkářské z filcem  
 RO Gletiera PVC cu pasla  
 H Műanyag simító vakoláshoz, filcel  
 E Llana de plástico para enlucido con fieltro



No.	mm	☐
06510	270x130	20

- PL Paca styropianowa  
 GB Polystyrene plastering trowel  
 D Styropor-reibebrett  
 RUS Тёрка пенопластовая
- CZ Polystyrénové hladítko  
 RO Gletiera poliuretan  
 H Habszivacs simító  
 E Llana de polietileno



No.	mm	☐
06400	130x270	10
06410	140x500	10
06440	170x320	10

- PL Paca styropianowa kątowna  
 GB Polystyrene plastering trowel  
 D Fummelbrett aus kunststoff  
 RUS Тёрка пенопластовая
- CZ Polystyrénové hladítko úhlové  
 RO Gletiera poliuretan unghiulara  
 H Habszivacs simító, derékszögű  
 E Llana de polietileno en angulo



No.	mm	☐
06401	80x340	10

- PL Paca tynkarska plastikowa  
 GB Plastic plastering trowel  
 D Glätkele  
 RUS Гладилка пластиковая
- CZ Umělohmotné hladítko omítkářské  
 RO Gletiera PVC  
 H Műanyag simító vakoláshoz  
 E Llana de plástico para enlucido



No.	mm	☐
06500	270x130	24

- PL Paca tynkarska miękka guma  
 GB Soft rubber plastering trowel  
 D Gummireibebrett  
 RUS Тёрка пластмассовая с резиновым покрытием  
 CZ Umělohmotné hladítko omítkářské z měkkou gumou  
 RO Gletiera PVC cu cauciuc  
 H Műanyag simító vakoláshoz, lágy gumival  
 E Llana de plástico para enlucido con goma suave



No.	mm	☐
06520	270x130	30

- PL Paca tynkarska gęsta gąbka  
 GB Plastering trowel  
 D Schwamm Brett  
 RUS Тёрка штукатурная с поролоновым покрытием (пластмассовая)  
 CZ Umělohmotné hladítko omítkářské z hustou houbou  
 RO Gletiera PVC cu burete dens  
 H Műanyag simító vakoláshoz, tömör szivacsos  
 E Lana de plástico para enlucido con esponja densa



No.	mm	
06530	270x130	20

- PL Paca tynkarska metalowa nierdzewna  
 GB Stainless steel plastering trowel  
 D Schweizer glätte  
 RUS Гладилка нержавеющей гладкая  
 CZ Hladítko omítkářské nerezavějící  
 RO Gletiera inox  
 H Rozsdamentes simító vakoláshoz  
 E Llana para enlucido acero inox. llano



No.	mm	
06640	380x128	10
06660	480x128	10
06680	580x128	18

- PL Paca tynkarska metalowa nierdzewna  
 GB Stainless steel plastering trowel  
 D Glättekelle  
 RUS Гладилка нержавеющая с пластмассовой ручкой  
 CZ Hladítko omítkářské nerezavějící  
 RO Gletiera inox maner plastic  
 H Rozsdamentes simító vakoláshoz  
 E Llana para enlucido acero inox. llano



No.	mm	
06700	270x125	24

- PL Paca tynkarska metalowa nierdzewna  
 GB Stainless steel plastering trowel  
 D Glättekelle gezahnt  
 RUS Гладилка нержавеющей зубчатая  
 CZ Hladítko omítkářské nerezavějící  
 RO Gletiera inox  
 H Rozsdamentes simító vakoláshoz  
 E Llana para enlucido acero inox. llano



No.	mm	teeth / zęby (mm)	
06740	270x125	4x4	24
06760	270x125	6x6	24
06780	270x125	8x8	24
06781	270x125	10x10	24

- PL Paca tynkarska rzadka gąbka  
 GB Plastering trowel  
 D Schwamm Brett  
 RUS Тёрка штукатурная с поролоновым покрытием (пластмассовая)  
 CZ Umělohmotné hladítko omítkářské z řídkou houbou  
 RO Gletiera PVC cu burete rar  
 H Műanyag simító vakoláshoz, lágy szivacsos  
 E Llana de plástico para enlucido con esponja poco densa



No.	mm	
06540	270x130	20

- PL Paca tynkarska metalowa nierdzewna  
 GB Stainless steel plastering trowel  
 D Schweizer glätte gezahnt  
 RUS Гладилка металлическая зубчатая  
 CZ Hladítko omítkářské nerezavějící  
 RO Gletiera inox  
 H Rozsdamentes simító vakoláshoz  
 E Llana para enlucido acero inox. llano



No.	mm	teeth / zęby (mm)	
06650	380x128	8x8	10
06670	480x128	8x8	10
06690	580x128	8x8	18

- PL Paca tynkarska metalowa nierdzewna, podstawa aluminium  
 GB Stainless steel plastering trowel  
 D Glättekelle  
 RUS Гладилка стальная нержавеющая гладкая  
 CZ Hladítko omítkářské nerezavějící  
 RO Gletiera inox  
 H Rozsdamentes simító vakoláshoz  
 E Llana para enlucido acero inox. llano



No.	mm	
06701	270x130	24

- PL Paca miękka z gumą do fugowania  
 GB Float with soft rubber  
 D Weiches Reibebrett mit Gummi zum Verfugen  
 RUS Тёрка для затирки швов  
 CZ Hladítko měkké s gumou na spárování  
 RO Pac moale cu cauciuc pt. cimentare  
 H Fugázó simító puha gumival  
 E Llana suave con goma para rejuntar



No.	mm	
06512	260x95	12



- PL** Paca plastikowa z gąbką nacinaną  
**GB** Plastic float with incised sponge  
**D** Reibebrett aus Kunststoff, mit aufgeschnittenem Schwamm  
**RUS** Пластиковый шпатель с надрезной губкой  
**CZ** Plastové hladítko s nařezanou houbou  
**RO** Netezitoare din plastic cu burete tăiat  
**H** Műanyag simító, szivaccsal  
**E** Liana de plástico con esponja entallada

**VOREL**

No.	L (mm)	sponge thickness / grubość gąbki (mm)	
06532	270x130	30	20

- PL** Kielnia trójkątna  
**GB** Brick trowel  
**D** Spitzkelle  
**RUS** Кельма треугольная  
**CZ** Zednická lžice trojúhelníková  
**RO** Mistrie triunghiulară  
**H** Háromszög vakolókanál  
**E** Paleta triangular

**VOREL**

No.	mm	
06340	180	50
06350	200	50
06360	220	50

- PL** Kielnia trapezowa nierdzewna  
**GB** Stainless steel brick trowel  
**D** Stukkaturkelle  
**RUS** Кельма шпательная нержавеющая  
**CZ** Lichoběžníková zednická lžice nerezavějící  
**RO** Mistrie trapezoidală inoxidabilă  
**H** Trapéz vakolókanál, rozsdamentes  
**E** Paleta trapezoidal de acero inox.

**VOREL**

No.	mm	
06370	130	50
06380	180	30

- PL** Kielnia do betonu komórkowego  
**GB** Trowel for areated blocks  
**D** Kelle für Porenbeton  
**RUS** Кельма для газобетона  
**CZ** Zednická lžice na pórobeton  
**RO** Mistrie pt. bca  
**H** Habarcsterítő kanál sejtbetonhoz  
**E** Allanadora para hormigón celular

**VOREL**

No.	mm	
05801	100	10
05802	115	10
05803	125	10
05804	200	10
05805	240	10
05806	300	10
05807	365	10

- PL** Paca plastikowa z hydrogumą  
**GB** Plastic float with hydrorubber  
**D** Reibebrett aus Kunststoff, mit Hydrogummi  
**RUS** Терка шлифовальная с мягкой губчатой накладкой  
**CZ** Plastové hladítko s pěnovou gumou  
**RO** Netezitoare din plastic cu hidrocauciu  
**H** Műanyag simító, durva szivaccsal  
**E** Liana de plástico con hidrocaucho

**VOREL**

No.	L (mm)	rubber thickness / grubość gummy (mm)	
06537	270x130	9	20
06538	270x130	18	20

- PL** Kielnia trójkątna nierdzewna  
**GB** Stainless steel brick trowel  
**D** Spitzkelle  
**RUS** Кельма треугольная нержавеющая  
**CZ** Zednická lžice trojúhelníková nerezavějící  
**RO** Mistrie triunghiulară inoxidabilă  
**H** Háromszög vakolókanál, rozsdamentes  
**E** Paleta triangular de acero inox.

**VOREL**

No.	mm	
06341	180	50
06351	200	30

- PL** Kielnia sztukatorska, podkowa  
**GB** Stainless steel scraper  
**D** Stukkateurspachtel  
**RUS** Кельма штукатурная  
**CZ** Ohnutá špachtle nerezavějící  
**RO** Șpaclu indoit inoxidabil  
**H** Spatula hajlítot, rozsdamentes  
**E** Espatula de acero inox curvo

**VOREL**

No.	mm	
06110	60x110	50
06120	80x120	50



- PL Wiertło do bloczków  
 GB Borer for aerated blocks  
 D Bohrer für Porenbeton  
 RUS Сверло по газобетону
- CZ Vrták do kvádrů  
 RO Sfredel pt. bca  
 H Falfúró  
 E Taladro para bloques



No.	mm	
05821	60	20
05822	80	20
05823	120	20

- PL Zdzierak wyrównujący z ząbkami  
 GB Scraper with teeth for plaster and aerated blocks  
 D Ausgleichbrett mit Zähnen  
 RUS Скребок-рубанок для газобетона зубчатый  
 CZ Vyrovnávací škrabák se zoubky  
 RO Drișcă nivelare cu dinți  
 H Fogas, kiegyenlítő dörzsölő  
 E Raspador con dientes



No.	mm	
05831	80x240	10

- PL Rylec do betonu komórkowego  
 GB Grooving device for aerated concrete  
 D Werkzeug für Porenbeton bohrung  
 RUS Штроборез по газобетону
- CZ Drážkovač na pórobeton  
 RO Dispozitiv canelat bca  
 H Horonymaró sejtbetonhoz  
 E Cincel para hormigón celular



No.		
05850		24

- PL Pila do gazobetonu  
 GB Saw for gas concrete  
 D Gasbetonsäge  
 RUS Пила по газобетону с твердосплавным зубом  
 CZ Pila na plynobeton  
 RO Fierastrau cu placute vidia pt. beton  
 H Fűrész gázbetonhoz  
 E Sierra para gas hormigón



No.	L (mm)	teeth / zęby	
28011	600	15	6/12
28012	660	34	6/12

- PL Zdzierak wyrównujący  
 GB Scraper for plaster and aerated blocks  
 D Schaber Gipskartonplatten und belüftete Blöcke  
 RUS Скребок-рубанок, зубчатый  
 CZ Vyrovnávací škrabák  
 RO Gletiera lem pt. tencuieli  
 H Kiegyenlítő dörzsölő  
 E Raspador



No.	mm	
05830	80x240	10

- PL Przymiar do cięcia pod kątem  
 GB Template tool for aerated blocks cut  
 D Werkzeug für Porenbeton schneiden  
 RUS Угольник для резки газобетона  
 CZ Pravitko k řezání pod úhlem  
 RO Dispozitiv pt. taiat bca  
 H Gérvágó tok  
 E Calibre de comprobación para cortes angulares



No.		
05840		4

- PL Pila do gazobetonu  
 GB Saw for gas concrete  
 D Gasbetonsäge  
 RUS Пила по газобетону с твердосплавным зубом  
 CZ Pila na plynobeton  
 RO Fierastrau cu placute vidia pt. BCA  
 H Fűrész gázbetonhoz  
 E Sierra para gas hormigón



No.	L (mm)	teeth / zęby	
28000	600	33/33	5
28010	600	33/17	5

- PL Szpachelka  
 GB Scraper  
 D Malerspachtel  
 RUS Шпатель
- CZ Špachtle  
 RO Șpactlu  
 H Spatula  
 E Espatula



No.	mm	
06030	30	12/240
06040	40	12/240
06050	50	12/240
06060	60	12/240
06080	80	12/240
06100	100	12/240

PL Komplet szpachelek  
GB Scraper set  
D Malerspachtelsatz  
RUS Набор шпателей

CZ Špachtle  
RO Spacluri  
H Spatula  
E Espátulas

3 PCS  
30 mm  
50 mm  
80 mm



No.	mm	pcs	
06130	30; 50; 80	3	25/100

PL Szpachelka kątowa wewnętrzna  
GB Stainless steel scraper  
D Kelle für Innenecken  
RUS Кельма для внутренних углов

CZ Úhlová špachtle vnitřní  
RO Spaclu unghiular interior  
H Belsőél kanál  
E Paleta en angulo

80x60x60 mm

STAINLESS STEEL  
STAL  
NERDZEWNIA



No.	mm	
06150	80x60x60	50

PL Szpachla malarska nierdzewna  
GB Stainless steel putty knife  
D Glasurzange  
RUS Шпатель фасадный

CZ Malířská špachtle nerezavějící  
RO Spaclu de chituit, inox, maner plastic  
H Rozsdamentes festőspatula  
E Espátula de pintura, de acero inox

STAINLESS STEEL  
STAL  
NERDZEWNIA



No.	mm	
06294	40	100
06295	60	80
06296	80	60
06297	100	50
06298	150	80
06301	200	60
06304	250	50
06307	350	25
06308	450	25
06309	600	10

PL Szpachla gumowa do fugowania  
GB Rubber grout spreader  
D Gummispachtel  
RUS Шпатель резиновый для фуговки

CZ Pryžová špachtle na fugování  
RO Spaclu cauciucat pt. rosturi  
H Fugázógumi  
E Espátula de goma para rejuntar

No.	mm	
06310	150	30
06320	200	30
06330	250	30
06331	300	30

PL Szpachelka kątowa zewnętrzna  
GB Stainless steel scraper  
D Kelle für Aussenecken  
RUS Кельма для наружных углов

CZ Úhlová špachtle vnější  
RO Spaclu unghiular exterior  
H Külsőél kanál  
E Paleta en angulo

80x60x60 mm

STAINLESS STEEL  
STAL  
NERDZEWNIA



No.	mm	
06140	80x60x60	50

PL Szpachelki „japonki” nierdzewne  
GB Stainless steel scraper set  
D Aufstreichspachtel  
RUS Набор шпателей нержавеющей тип „японский”  
CZ Špachtle japonky nerezavějící  
RO Spaclu japonez inox set  
H Spatula rozsdamentes  
E Espátulas „japonesas” de acero inox

4 PCS  
50 mm  
80 mm

100 mm  
120 mm

STAINLESS STEEL  
STAL  
NERDZEWNIA



No.	mm	pcs	
06290	50; 80; 100; 120	4	12/120

PL Szpachla nierdzewna  
GB Stainless steel putty knife  
D Kleberspachtel  
RUS Шпатель фасадный зубчатый

CZ Špachtle nerezavějící  
RO Spaclu de chituit, inox, maner plastic, crestat  
H Rozsdamentes spatula  
E Espátula de acero inox.

STAINLESS STEEL  
STAL  
NERDZEWNIA



No.	mm	teeth / zęby (mm)	
06299	150	6x6	80
06300	150	8x8	80
06302	200	6x6	60
06303	200	8x8	60
06305	250	6x6	50
06306	250	8x8	50



STAINLESS STEEL  
STAL  
NERDZEWNIA

PL Szpachelka nierdzewna  
GB Stainless steel scraper  
D Rostfrei Spachtel  
RUS Шпатель нержавеющей

CZ Špachtle  
RO Șpaclu  
H Spatula  
E Espatula de acero inox



**VOREL**

No.	mm	
05901	30	6/72
05902	40	6/72
05903	50	6/72
05904	60	6/72
05905	80	6/72
05906	100	6/72

PL Szpachelka nierdzewna wygięta  
GB Stainless steel scraper  
D Rostfrei Spachtel  
RUS Шпатель нержавеющей изогнутой

CZ Špachtle  
RO Șpaclu  
H Spatula  
E Espatula de acero inox curvo



**VOREL**

No.	mm	
05921	30	6/72
05922	40	6/72
05923	50	6/72
05924	60	6/72
05925	80	6/72
05926	100	6/72

PL Skrobak malarski  
GB Painting scraper  
D Malerabkratzer  
RUS Скребок для удаления краски

CZ Škrabka malířská  
RO Răzuitor pt. zugrăvi  
H Festékvakaró  
E Rascador de pintor



No.	W (mm)	
06797	115	50

PL Czerpak murarski  
GB Mason's pan  
D Gipsfänchen  
RUS Ковш штукатурный

CZ Zednický koreček  
RO Cancioc  
H Kőműveskanál  
E Achicador de albanil



**VOREL**

No.		
06335		50

PL Szpachelka nierdzewna  
GB Stainless steel scraper  
D Rostfrei Spachtel  
RUS Шпатель нержавеющей

CZ Špachtle  
RO Șpaclu  
H Spatula  
E Espatula de acero inox



**VOREL**

No.	mm	
05911	30	6/72
05912	40	6/72
05913	50	6/72
05914	60	6/72
05915	80	6/72
05916	100	6/72

PL Skrobak malarski  
GB Painting scraper  
D Malerabkratzer  
RUS Скребок для краски со сменным лезвием

CZ Škrabka malířská  
RO Răzuitor pt. zugrăvi  
H Festékvakaró  
E Rascador de pintor



No.	blade / ostrze L (mm)	
06795	100	60

PL Ostrze do skrobaka 06795  
GB Spare blades for 06795  
D Schneide für 06795  
RUS Сменные лезвия для скребка 06795

CZ Ostří do škrabky  
RO Taiș pt. răzuitor  
H Festékvakaró-pengék  
E Filo para rascador



No.	for / dla	pcs. packing	
06796	06795	5	10/100

PL Sito budowlane  
GB Building strainer  
D Bau Sieb  
RUS Сито строительное  
CZ Prohazovací síto stavební  
RO Sită construcții  
H Építőipari rosta  
E Cedazo para construcción



**VOREL**

No.	cm	size of eyelet / rozmiar oczka (mm)	
34944	60x100	4	30
34945	60x100	6	30
34946	60x100	8	30
34947	60x100	10	30

PL Mieszadło do farbu  
GB Paint mixer  
D Farbmischer  
RUS Мешалка для краски

CZ Míchadlo na hmoty  
RO Mixer vopsea / var  
H Keverő festékekhez  
E Mezclador para pinturas



No.	mm	
09060	60x400	40/80
09080	85x400	40/80
09090	100x600	30

PL Mieszadło do zapraw i klejów  
GB Mixer for compound and glue  
D Wendelrührer  
RUS Мешалка для клеевой массы и цемента

CZ Míchadlo na malty a lepidla  
RO Agitator pt. mortar și cleiuri  
H Habarcs és ragasztó keverő  
E Mezcladora para morteros y pegamientos



No.	mm	
09010	110x510	40

PL Mieszadło do gipsu i gładzi  
GB Mixer for gypsum and coat  
D Gips- und wachsrührer  
RUS Мешалка для гипса

CZ Míchadlo na sádku a stěrku  
RO Agitator pt. ipsos și honuituri  
H Gipsz és glett keverő  
E Mezcladora para yeso



No.	mm	type	
09025	75x370	C-75	20

PL Mieszadło do mas  
GB Mixer for compound  
D Rührer für Materialien auf bitumenbasis  
RUS Мешалка для штукатурки

CZ Míchadlo na stavební hmoty  
RO Agitator pt. mase  
H Keverő masszához  
E Mezcladora para masas



No.	mm	type	
09048	75x400	C-75	20
09049	85x450	C-85	20
09050	100x500	C-100	20
09051	110x550	C-110	20

PL Mieszadło do zapraw i klejów  
GB Mixer for compound and glue  
D Wendelrührer  
RUS Мешалка для клеевой массы и цемента

CZ Míchadlo na malty a lepidla  
RO Agitator pt. mortar și cleiuri  
H Habarcs és ragasztó keverő  
E Mezcladora para morteros y pegamientos



No.	mm	
09005	65x410	40
09006	80x410	40

PL Mieszadło do gipsu i gładzi  
GB Mixer for gypsum and coat  
D Gips- und wachsrührer  
RUS Мешалка для гипса

CZ Míchadlo na sádku a stěrku  
RO Agitator pt. ipsos și honuituri  
H Gipsz és glett keverő  
E Mezcladora para yeso



No.	mm	
09015	85x400	40
09017	100x500	20

PL Mieszadło do mas  
GB Mixer for compound  
D Rührer für Materialien auf bitumenbasis  
RUS Мешалка для штукатурки

CZ Míchadlo na stavební hmoty  
RO Agitator pt. mase  
H Keverő masszához  
E Mezcladora para masas



No.	mm	
09044	80x400	25
09046	100x600	25

PL Mieszadło do mas  
GB Mixer for compound  
D Rührer für Materialien auf bitumenbasis  
RUS Мешалка для штукатурки

CZ Míchadlo na stavební hmoty  
RO Agitator pt. mase  
H Keverő masszához  
E Mezcladora para masas



No.	mm	
09054	80x400	25
09056	100x600	25

PL Mieszadło do materiałów sypkich  
GB Mixer for loose materials  
D Mischer  
RUS Мешалка для гипса

CZ Míchadlo na sypké materiály  
RO Agitator pt. materiale vârsătoare  
H Keverő szóródó anyagokhoz  
E Mezcladora para materiales sueltos



No.	mm	
09028	80x400	35

PL Mieszadło  
GB Mixer  
D Rondenührer  
RUS Мешалка для штукатурки

CZ Míchadlo  
RO Mixer  
H Keverő  
E Mezcladora



No.	mm	type	
09094	120x600	C-120	10

PL Walek do odpowietrzania  
GB Deaeration roller  
D Entlüftungsrolle  
RUS Валик азэрационный

CZ Váleček na odvzdušňování  
RO Rola pt. modelare sapa  
H Levegőkinyomó henger  
E Rodillo para hacer el vacío



VOREL

No.	mm	
06450	75x230	15
06452	110x230	10

PL Walek malarski Syntex  
GB Paint roller Syntex  
D Malerroller Syntex  
RUS Валик в сборе полиакрил

CZ Malířský váleček  
RO Trafalet Syntex  
H Festöhenger  
E Rodilli de pintura



VOREL

No.	W (mm)	handle / uchwyt Ø (mm)	
09307	180	6	55
09308	250	6	50

PL Mieszadło do mas  
GB Mixer for compound  
D Mörtel Mischer  
RUS Мешалка для штукатурки

CZ Míchadlo na stavební hmoty  
RO Agitator pt. mase  
H Keverő masszához  
E Mezcladora para masas



No.	mm	
09036	60x400	60
09038	80x400	35
09040	100x600	30

PL Mieszadło turbo z gwintem  
GB Turbo threaded stirrer  
D Turbomischer mit Gewinde  
RUS Мешалка с резьбой

CZ Míchadlo turbo se závitem  
RO Dispozitiv de amestecat turbo cu filet  
H Menetes, turbó keverő  
E Turbo mezcladora con rosca



No.	mm	type	
09063	115x580	M14	10
09065	135x580	M14	10

PL Walek do odpowietrzania  
GB Deaeration roller  
D Entlüftungsrolle  
RUS Валик азэрационный

CZ Váleček na odvzdušňování  
RO Rola pt. modelare sapa  
H Levegőkinyomó henger  
E Rodillo para hacer el vacío

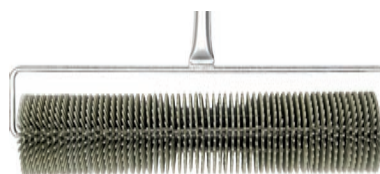

VOREL

No.	mm	
06453	110x500	6

PL Walek malarski Girpaint  
GB Paint roller Girpaint  
D Malerroller Girpaint  
RUS Валик полиакрил в сборе

CZ Malířský váleček Girpaint  
RO Trafalet cu fir galban  
H Festöhenger Girpaint  
E Rodilli de pintura Girpaint



VOREL

No.	W (mm)	handle / uchwyt Ø (mm)	
09334	100	6	40
09336	180	6	60

**PL** Walek malarski Vestan  
**GB** Paint roller Vestan  
**D** Malerroller  
**RUS** Валик в сборе, полиакрил

**CZ** Malířský váleček  
**RO** Trafalet lana artificiala  
**H** Festőhenger  
**E** Rodillí de pintura



**VOREL**

No.	W (mm)	handle / uchwył Ø (mm)	
09345	180	6	55
09346	250	6	50

**PL** Walek malarski Moltopren  
**GB** Paint roller Moltopren  
**D** Malerroller Moltopren  
**RUS** Валик в сборе поролон

**CZ** Malířský váleček  
**RO** Trafalet Burete cu tija plastic  
**H** Festőhenger  
**E** Rodillí de pintura



**VOREL**

No.	mm	handle / uchwył Ø (mm)	
09370	35x50	6	70

**PL** Zapas do walka Multicolor  
**GB** Paint roller refill Multicolor  
**D** Maler-Ersatzwalzen Multicolor  
**RUS** Шубка полиамидовая для валика

**CZ** Náhradní váleček Multicolor  
**RO** Rezerva trafalet fir Multicolor  
**H** Csere festőhenger Multicolor  
**E** Lana de polietileno Multicolor



**VOREL**

No.	W (mm)	handle / uchwył Ø (mm)	
09302	180	6	40
09303	250	8	25

**PL** Zapas do walka  
**GB** Paint roller refill  
**D** Maler-Ersatzwalzen  
**RUS** Шубка нейлоновая для валика

**CZ** Náhradní váleček  
**RO** Rezerva trafalet acril rosu  
**H** Csere festőhenger  
**E** Repuesto para el cilindro

NYLON



**VOREL**

No.	W (mm)	handle / uchwył Ø (mm)	
09331	180	6	10/50
09332	250	8	10/40

**PL** Walek malarski Flok  
**GB** Paint roller Flok  
**D** Malerroller Flok  
**RUS** Валик в сборе мольтопрен

**CZ** Malířský váleček  
**RO** Trafalet burete fin  
**H** Festőhenger  
**E** Rodillí de pintura



**VOREL**

No.	W (mm)	handle / uchwył Ø (mm)	
09359	50x150	6	50

**PL** Walek malarski Moltopren  
**GB** Paint roller Moltopren  
**D** Malerroller Moltopren  
**RUS** Валик в сборе поролон

**CZ** Malířský váleček  
**RO** Trafalet Burete cu tija plastic  
**H** Festőhenger  
**E** Rodillí de pintura



**VOREL**

No.	mm	handle / uchwył Ø (mm)	
09371	35x70	6	80
09372	35x100	6	70
09373	50x150	6	50

**PL** Zapas do walka Syntex  
**GB** Paint roller refill Syntex  
**D** Maler-Ersatzwalzen Syntex  
**RUS** Шубка полиакриловая для валика

**CZ** Náhradní váleček Syntex  
**RO** Rezerva trafalet Acril Verde  
**H** Csere Syntex hengerhez  
**E** Repuesto para el cilindro Syntex



**VOREL**

No.	W (mm)	handle / uchwył Ø (mm)	
09310	180	6	10/40
09311	250	6	40

**PL** Zapas do walka Girpaint  
**GB** Paint roller refill Girpaint  
**D** Maler-Ersatzwalzen Girpaint  
**RUS** Шубка полиамидная для валика

**CZ** Náhradní váleček Girpaint  
**RO** Rezerva trafalet fir galben  
**H** Csere festőhenger Girpaint  
**E** Repuesto para el cilindro Girpaint



**VOREL**

No.	W (mm)	handle / uchwył Ø (mm)	pcs packing	
09338	100	6	2	150

PL Zapas do wałka Flok  
GB Paint roller refill Flok  
D Maler-Ersatzwalzen Flok  
RUS Шубка мольтопрен

CZ Náhradní váleček Flok  
RO Rezerve trafalet burete fin  
H Csere festőhenger Flok  
E Esponja de recambio



**VOREL**

No.	W (mm)	handle / uchwył Ø (mm)	pcs packing	
09363	35x50	6	2	75
09365	35x100	6	2	80

PL Kuweta malarska  
GB Painting bowl  
D Malerschale  
RUS Ванночка малярная

CZ Malířská kyveta  
RO Tava-suport trafalet  
H Kúvetta  
E Cuveta

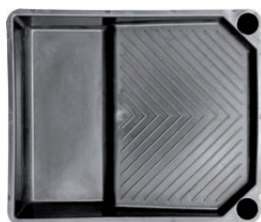

**VOREL**

No.	mm	
09406	150x245	150
09408	330x350	60

PL Walek malarski Vestan z kratką  
GB Paint roller set Vestan  
D Malerroller Vestan mit Abtropfgitter  
RUS Валик с решёткой

CZ Malířský váleček + mřížka  
RO Trafalet cu gratar  
H Festőhenger + rács  
E Rodillo de pintura + rejilla



**VOREL**

No.	W (mm)	handle / uchwył Ø (mm)	
09385	180	6	25

PL Walek malarski Moltopren z kuwetą  
GB Paint roller set Moltopren  
D Malerroller Moltopren mit Malerschale  
RUS Набор для покраски: ванночка, валик

CZ Malířský váleček + kyveta  
RO Trafalet cu tava  
H Festőhenger + kúvetta  
E Rodillo esponja + cuveta



**VOREL**

No.	W (mm)	handle / uchwył Ø (mm)	
09395	50	6	60

PL Zapas do wałka Moltopren  
GB Paint roller refill Moltopren  
D Maler-Ersatzwalzen Moltopren  
RUS Шубка мольтопрен

CZ Náhradní váleček Moltopren  
RO Rezerve trafalet burete  
H Csere festőhenger Moltopren  
E Esponja de recambio

2  
PCS



**VOREL**

No.	mm	handle / uchwył Ø (mm)	pcs packing	
09375	35x50	6	2	200
09377	35x100	6	2	90
09378	50x150	6	2	45

PL Kratka malarska  
GB Painting grid  
D Farbenabrollgitter  
RUS Решетка малярная

CZ Malířská mřížka  
RO Grătar pt. zugrăvit  
H Festőrács  
E Rejilla para pintar



**VOREL**

No.	mm	
09412	210x255	100
09413	265x285	100

PL Walek malarski Vestan z kuwetą  
GB Paint roller set Vestan  
D Malerroller Vestan mit Malerschale  
RUS Набор для покраски: ванночка, валик

CZ Malířský váleček  
RO Trafalet cu tava  
H Festőhenger + kúvetta  
E Rodillo de pelo + cuveta



**VOREL**

No.	W (mm)	handle / uchwył Ø (mm)	
09390	180	6	12

PL Uchwył do wałka  
GB Paint roller handle  
D Malerroller-Griff  
RUS Ручка для валика  
CZ Držák válečku  
RO Maner trafalet  
H Festőhenger nyél  
E Mango del cilindro



**VOREL**

No.	W (mm)	handle / uchwył Ø (mm)	
09421	50/70	6	90
09422	100	6	90
09425	150	6	150
09427	180	6	110
09429	250	6	110
09430	250	8	80



- PL Pędzel angielski  
 GB Flat paint brush  
 D Flachpinsel  
 RUS Кисть флейцевая
- CZ Anglický štětec  
 RO Pensulă englezească  
 H Laposecset  
 E Brocha plana



No.	W (mm)	
09521	25	50
09522	36	50
09523	50	50
09524	63	50
09525	76	50

- PL Pędzel kaloryferowy  
 GB Angled paint brush  
 D Heizkörperpinsel  
 RUS Кисть радиаторная
- CZ Štětec na topná tělesa  
 RO Pensulă pt. calorifere  
 H Radiátorecset  
 E Brocha angulara de radiadores



No.	W (mm)	
09560	25	50
09561	36	50
09562	50	50

- PL Pędzel do tapet  
 GB Brush for wallpapers  
 D Flächenstreicher  
 RUS Кисть-макловица деревянная ручка
- CZ Štětec na tapety dřevěný  
 RO Bidinea profi pt. tapet  
 H Ecset fa tapétához  
 E Brocha de empapelar madero



No.	mm	
09636	110	30
09638	130	30
09640	140	30
09642	150	30

- PL Chłapacz PCV  
 GB Paint brush  
 D Deckenbürste  
 RUS Кисть-макловица ПВХ
- CZ Smeták PVC  
 RO Bidinea PVC  
 H PVC meszelő  
 E Brocha de PVC



No.	mm	
09651	60x170	30

- PL Pędzel angielski profesjonalny  
 GB Flat paint brush profi  
 D Flachpinsel  
 RUS Кисть флейцевая
- CZ Anglický štětec profesionální  
 RO Pensulă englezească profesională  
 H Profesionális laposecset  
 E Brocha plana prof.



No.	W (mm)	
09531	25	50
09532	36	50
09533	50	50
09534	62	50
09535	75	50
09536	87	50
09537	102	50

- PL Pędzel okrągły  
 GB Round paint brush  
 D Ringpinsel  
 RUS Кисть круглая
- CZ Kulatý štětec  
 RO Pensula rotundă  
 H Marokecset  
 E Brocha redonda



No.	W (mm)	
09581	20	50
09583	30	50
09585	40	50
09587	50	50
09589	60	50

- PL Ławkowiec  
 GB Paint brush  
 D Malerbürste  
 RUS Кисть-макловица деревянная ручка
- CZ Natírací kartáč profesionální  
 RO Bidinea profesională  
 H Profesionális kenőkefe  
 E Brocha prof.



No.	mm	
09647	170	10
09648	180	10
09649	190	10

- PL Pędzle malarskie  
 GB Paint brushes  
 D Pinselset  
 RUS Набор кистей
- CZ Sada malířských štětců  
 RO Set pensule  
 H Festőecset készlet  
 E Brochas de pintar



No.	W (mm)	pcs	
09920	25; 36; 50	3	25/200
09930	36; 50; 63	3	40/160
09950	13; 25; 36; 50; 63	5	25/100

- PL Ławkowiec PET  
 GB Paint brush  
 D Malerbürste  
 RUS Кисть-макловица PET
- CZ Natírací kartáč  
 RO Bidinea  
 H Kenőkefe  
 E Brocha



No.	mm	
09650	70x170	12

- PL Folia malarska  
 GB Painting sheet  
 D Abdeckfolie  
 RUS Плёнка защитная
- CZ Malířská fólie  
 RO Folie de vâruit  
 H Festőfólia  
 E Lona protectora de pintura



No.	m	
09462	4x5	40

- PL Folia ochronna budowlana  
 GB Sheet for construction works  
 D Abdeckplane  
 RUS Плёнка защитная строительная
- CZ Stavební fólie  
 RO Folie pt. constructii  
 H Építési fólia  
 E Lona protectora



No.	m	
09457	4x5	15

- PL Folia budowlana mocna  
 GB Sheet for construction works  
 D Abdeckplane  
 RUS Плёнка защитная строительная повышенной прочности
- CZ Stavební fólie  
 RO Folie pt. constructii  
 H Építési fólia  
 E Lona protectora



No.	m	
09459	4x5	10

- PL Smolowiec  
 GB Brush for pitch  
 D Pechstein  
 RUS Кисть для смолы
- CZ Kartáč asfalterský  
 RO Perie pt. asfalt  
 H Kátránykenő kefe  
 E Brocha para alquitrán



No.	mm	
09653	195	30

- PL Folia ochronna  
 GB Sheet for construction works  
 D Abdeckplane  
 RUS Плёнка защитная
- CZ Stavební fólie  
 RO Folie pt. constructii  
 H Építési fólia  
 E Lona protectora



No.	m	
09463	4x5	20

- PL Kombinezon malarski  
 GB Painting suit  
 D Maleranzug  
 RUS Комбинезон защитный малярный
- CZ Kombinéza malířská  
 RO Salopetă pt. vopsitor  
 H Festő kezelőruha  
 E Mono de pintor



No.	size / rozmiar	
74652	XXL	50

**PL** Worki na gruz, mocne  
**GB** Debris bags  
**D** Müllsäcke stabil  
**RUS** Мешки для строительного мусора

**CZ** Pytle na suť  
**RO** Saci pt. demolari  
**H** Sittes zsák  
**E** Bolsas para escombros

**VOREL**

No.	l	pcs packing	µm	
09475	80	10	142	10
09476	80	3	142	10
09477	120	10	142	10
09478	120	3	142	10

**PL** Taśma papierowa samoprzylepna  
**GB** Self adhesive paper tape  
**D** Papierband selbstklebend  
**RUS** Лента малярная бумажная  
**CZ** Páska papírová samolepící  
**RO** Banda adeziva hartie  
**H** Öntapadó papírszalag  
**E** Cinta de papel adhesiva



No.	W (mm)	L (m)	
75270	19	25	12/48
75271	25	25	36
75272	30	25	10/40
75273	38	25	6/24
75274	48	25	6/24
75285	25	50	9/36
75286	30	50	10/40
75287	38	50	6/24
75288	48	50	6/24

**PL** Taśma tynkarska elewacyjna  
**GB** Plastering tape  
**D** Putzband  
**RUS** Штукатурные ленты  
**CZ** Fasádní omítková páska  
**RO** Banda mascare pt. tencuieli  
**H** Homlokzati festő szalag  
**E** Cinta de escayola

**VOREL**

No.	W (mm)	L (m)	
75130	38	20	24
75131	48	20	24
75132	38	50	28
75133	48	50	24

**PL** Worki na odpady, budowlane  
**GB** Construction waste bags  
**D** Müllsäcke  
**RUS** Мешки для строительного мусора

**CZ** Pytle na stavební odpad  
**RO** Saci gunoii pt. santier  
**H** Zsák építési törmelékhez  
**E** Bolsas para desperdicios de construcción

**VOREL**

No.	l	pcs packing	µm	
09470	80	10	40	30
09471	120	15	60	10

**PL** Taśma maskująca, niebieska  
**GB** Blue masking tape  
**D** Malerei blau Tape  
**RUS** Малярна стрічка  
**CZ** Maskovací páska  
**RO** Bandă de mascare  
**H** Fedőszalag  
**E** Cinta de enmascarar

**VOREL**

No.	W (mm)	L (m)	
75120	30	25	40
75121	38	25	24
75122	48	25	24
75123	30	50	40
75124	38	50	24
75125	48	50	24

**PL** Taśma aluminiowa  
**GB** Aluminium tape  
**D** Aluminiumband  
**RUS** Алюминиевая клейкая лента

**CZ** Hliníková páska  
**RO** Bandă aluminiu  
**H** Alumínium szalag  
**E** Cinta de aluminiu

**VOREL**

No.	W (mm)	L (m)	
75140	48	10	36
75141	48	50	24

- PL Taśma dwustronna do wykładzin  
 GB Double-sided carpet tape  
 D Doppelseitiges Klebeband für Auslegwara  
 RUS Двухсторонняя клейкая лента для укладки ковровых покрытий  
 CZ Obojstranná lepicí páska (na podlahové krytiny)  
 RO Bandă cu două părți adezive pt. mochetă  
 H Kétoldalas szalag szőnyegpadlókhöz  
 E Cinta doble cara para alfombras



**VOREL**

No.	W (mm)	L (m)	
75260	50	5	48
75261	50	10	36
75262	50	25	24

- PL Taśma dwustronna na folii  
 GB Double-sided tape  
 D Doppelseitiges Band auf PP-Folie  
 RUS Клейкая лента двухсторонняя на полипропиленовой основе  
 CZ Obojstranná páska na PP folii  
 RO Bandă cu două fețe pt. folii  
 H Kétoldalas  
 E Cinta doble cara sobre la base de PP



**VOREL**

No.	W (mm)	L (m)	
75245	50	5	72
75246	50	10	72
75247	50	25	36

- PL Taśma pakowa brązowa  
 GB Packing tape, brown  
 D Verpackungsband aus PP, braun  
 RUS Упаковочная клейкая лента  
 CZ Balící páska PP hnědá  
 RO Bandă ambalare PP maro  
 H PP bama ragasztószalag  
 E Cinta de embalaje PP marrón



**VOREL**

No.	W (mm)	L (m)	
75301	48	40	72
75302	48	66	36

- PL Taśma pakowa  
 GB Packing tape  
 D Band  
 RUS Упаковочная клейкая лента
- CZ Balící páska  
 RO Banda scotch  
 H Csomagolószalag  
 E Cinta de embalaje



No.	W (mm)	L (m)	
75300	48	45	12/120

- PL Taśma tekstylna „DUCT”  
 GB „DUCT” tape  
 D Textilband „DUCT”  
 RUS Лента армированная на тканевой основе

- CZ Textilní páska „DUCT”  
 RO Bandă textilă „DUCT”  
 H „DUCT” textil szalag  
 E Cinta textil „DUCT”



**VOREL**

No.	W (mm)	L (m)	
75238	48	10	36
75239	38	50	32
75240	48	50	24

- PL Taśma samoprzylepna dwustronna  
 GB Mounting tape  
 D Doppelseitiges montageband  
 RUS Двухсторонняя монтажная лента
- CZ Páska montážní dvouvrstvá  
 RO Scotch cu banda dubla  
 H Kétoldalas ragasztószalag  
 E Cinta adhesiva, ambos lados

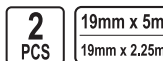

**VOREL**

No.	W (mm)	L (m)	
75100	19	2.25; 5	12/96

- PL Taśma pakowa przezroczysta  
 GB Packing tape, transparent  
 D Verpackungsband aus PP, durchsichtig  
 RUS Упаковочная клейкая лента  
 CZ Balící páska PP průhledná  
 RO Bandă ambalare PP transparentă  
 H Átlátszó ragasztószalag  
 E Cinta de embalaje PP transparente



**VOREL**

No.	W (mm)	L (m)	
75303	48	40	72
75304	48	66	36

- PL Taśma PCV do użytku zewnętrznego  
 GB PVC tape  
 D PVC Band  
 RUS Лента ПВХ для внешних работ

- CZ Páska PVC  
 RO Bandă PVC  
 H Kétoldalas PVC  
 E Cinta PVC



**VOREL**

No.	W (mm)	L (m)	
75031	48	33	50

- PL Wiadro budowlane  
GB Plastic bucket  
D Baueimer  
RUS Ведро строительное  
CZ Stavební vědro  
RO Găleată pt. construcții  
H Kőműves vödör  
E Cubo de obra



No.	l	
06388	10	900
06390	12	680
06393	16	450
06392	20	390

- PL Wiadro malarskie  
GB Painting bucket  
D Malereimer  
RUS Ведро малярное пластмассовое
- CZ Vědro malířské  
RO Găleată zidar  
H Festvödör  
E Cubo para pintar



No.	l	mm	
09400	14	360x250x225	315

- PL Kastra budowlana  
GB Tub for mass mixing  
D Mörtelkasten  
RUS Кювета для перемешивания раствора
- CZ Stavební vědro  
RO Vas plastic constructii  
H Kőműves vödör  
E Caba de obra



No.	l	
06394	40	210
06395	60	210
06396	90	120

- PL Uchwyt do szyb  
GB Suction lifter  
D Glas-Gummissauger  
RUS Держатель-присоска для стекла одинарная
- CZ Podtlakový úchyt na sklo  
RO Ventuze  
H Szélvédő kiemelő  
E Elevadores tipo ventosa



No.	Ø (mm)	kg	
05300	115	40	48

- PL Wiadro budowlane z wylewką  
GB Plastic bucket  
D Baueimer  
RUS Ведро строительное со сливом  
CZ Stavební vědro  
RO Găleată pt. construcții  
H Kőműves vödör  
E Cubo de obra con pico



No.	l	
06391	12	720

- PL Kastra budowlana  
GB Tub for mass mixing  
D Mörtelkasten  
RUS Таз строительный круглый
- CZ Stavební vědro  
RO Vas plastic constructii  
H Kőműves vödör  
E Caba de obra



No.	l	
06397	40	110
06398	65	100
06399	90	160

- PL Wiadro ocynkowane  
GB Galvanized bucket  
D Baueimer  
RUS Ведро оцинкованное  
CZ Vědro  
RO Găleată  
H Kőműves vödör  
E Cubo



No.	l	
89560	5	900
89561	7	450
89562	10	480
89563	12	360
89564	15	270

- PL Uchwyt do szyb  
GB Suction lifter  
D Glas-Gummissauger  
RUS Держатель-присоска для стекла двойная
- CZ Podtlakový úchyt na sklo  
RO Ventuze  
H Szélvédő kiemelő  
E Elevadores tipo ventosa



No.	Ø (mm)	kg	
05301	115	70	24

- PL Uchwyt do szyb  
GB Suction lifter  
D Glas-Gummissauger  
RUS Держатель-присоска для стекол тройная
- CZ Podtlakový úchyt na sklo  
RO Ventuze  
H Szélvédő kiemelő  
E Elevadores tipo ventosa

115  
Ømm

100  
kg



**VOREL**

No.	Ø (mm)	kg	
05302	115	100	12

- PL Uchwyt do szyb  
GB Suction lifter  
D Glas-Gummissauger  
RUS Держатель-присоска для стекол двойная
- CZ Podtlakový úchyt na sklo  
RO Ventuze  
H Szélvédő kiemelő  
E Elevadores tipo ventosa

115  
Ømm

70  
kg

AI





**VOREL**

No.	Ø (mm)	kg	
05312	115	70	10

- PL Ołówek stolarski  
GB Carpenter's pencil  
D Zimmermannsbleistift  
RUS Карандаш столярный
- CZ Tesařská tužka  
RO Creion de tâmplărie  
H Asztalos ceruza  
E Lapiz de carpintero

180  
mm





No.	L (mm)	pcs packing	
09180	180	12	60/240

- PL Giętarka łożyskowa do drutu  
GB Bearing bender for bar  
D Drahtbiegevorrichtung, mit Lager  
RUS Ручной станок для гибки арматуры  
CZ Ohýbačka drátu s ložiskem  
RO Dispozitiv pt. îndoit sărmă de armare  
H Csapágyas dróthajlító  
E Dobladora de alambre con rodamiento



**VOREL**

No.	Ø (mm)	mm	bearing / łożysko (mm)	
49805	6-8	17x17x5	35x15	2
49806	10-14	25x20x5	45x20	2

- PL Uchwyt do szyb  
GB Suction lifter  
D Glas-Gummissauger  
RUS Держатель-присоска для стекол одинарная
- CZ Podtlakový úchyt na sklo  
RO Ventuze  
H Szélvédő kiemelő  
E Elevadores tipo ventosa

115  
Ømm

40  
kg

AI





**VOREL**

No.	Ø (mm)	kg	
05311	115	40	50

- PL Hak budowlany  
GB Hook  
D Mauerhaken  
RUS Крюк строительный
- CZ Stavební hák  
RO Cârlig de construcții  
H Építőipari horog  
E Gancho de obra



**JUCO**

No.	
34950	25

- PL Temperówka do ołówek stolarskich  
GB Carpenter's pencil sharpener  
D Zimmermann-Bleistift-Anspitzer  
RUS Точилка для столярных карандашей
- CZ Ořezávkto na tesařskou tužku  
RO Ascutitoare pt. creioane de tâmplarie  
H Ceruzahegyező  
E Sacapuntas para lápiz de carpintero



**VOREL**

No.	
09190	40/240

- PL Giętarka do drutu zbrojeniowego  
GB Bender for reinforcement bar  
D Biegevorrichtung für Bewehrungsdraht  
RUS Ручной станок для гибки арматуры
- CZ Ohýbačka armovacího drátu  
RO Dispozitiv pt. îndoit sărmă de armare  
H Betonvas hajlító  
E Dobladora de alambre de reforzamiento



**VOREL**

No.	Ø (mm)	mm	
49800	6-8	16x12x5	4
49801	10-12	25x16x6	4
49802	14-16	25x16x6	2

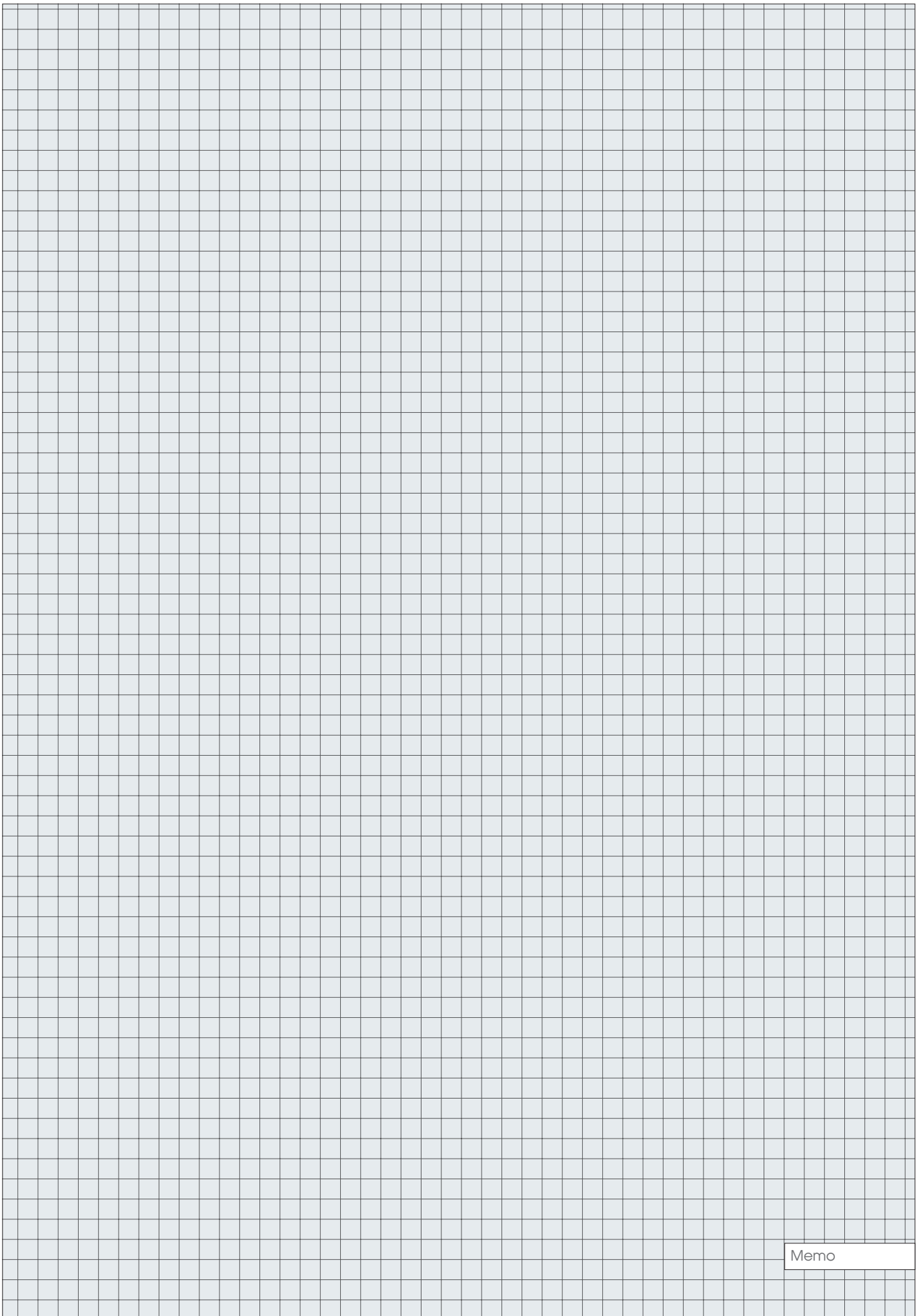

Memo

# 12

## Measuring tools Narzędzia miernicze





**Measuring tapes**  
 Miary zwijane

.160

**Wooden folding rules**  
 Miary składane drewniane

.161

**Plastic folding rules**  
 Miary składane z tworzywa

.161

**Feeler gauges**  
 Szczelinomierze

.161

**Vernier calipers**  
 Suwmiarki

.161-162

**Chalk lines**  
 Sznury traserskie

.162

**Ropes & lines**  
 Sznury i linki

.162-164

**Plumb bobs**  
 Piony murarskie

.164

**Try squares**  
 Kątowniki stolarskie

.164-165

**Rulers**  
 Przymiary

.165

**Electronic measuring tools**  
 Elektroniczne urządzenia pomiarowe

.165-166

**Levels**  
 Poziomnice

.166



PL Miara zwijana  
GB Measuring tape  
D Rollbandmass  
RUS Рулетка  
CZ Měřicí pásmo  
RO Ruleta din  
H Mérőszalag  
E Flexometro



**VOREL**

No.	L (m)	W (mm)	
10101	2	16	12/120
10104	3	16	12/120
10106	5	16	12/120
10109	7.5	19	6/60
10111	10	25	6/60

PL Miara zwijana  
GB Measuring tape  
D Rollbandmass  
RUS Рулетка  
CZ Měřicí pásmo  
RO Ruleta din  
H Mérőszalag  
E Flexometro



**VOREL**

No.	L (m)	W (mm)	
10130	2	16	12/120
10133	3	16	12/120
10135	5	16	12/120
10138	8	25	6/60
10139	10	25	6/60

PL Taśma miernicza stalowa  
GB Steel measuring tape  
D Rollbandmass  
RUS Мерная лента стальная

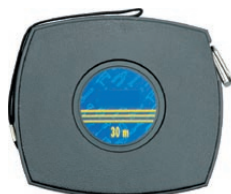

No.	L (m)	W (mm)	
12100	10	10	25/50
12200	20	10	25/50
12300	30	10	10/30
12500	50	10	10/30

PL Taśma miernicza stalowa, geodezyjna  
GB Steel measuring tape  
D Rollbandmass  
RUS Мерная лента стальная геодезическая

CZ Měřicí pásmo ocelové  
RO Ruleta cu picior  
H Acél mérőszalag  
E Cinta de mednir de acero geodezico



No.	L (m)	
13200	20	10/20
13300	30	10/20
13500	50	10/20

PL Miara zwijana  
GB Measuring tape  
D Rollbandmass  
RUS Рулетка  
CZ Měřicí pásmo  
RO Ruleta din  
H Mérőszalag  
E Flexometro



**VOREL**

No.	L (m)	W (mm)	
10122	2	16	12/120
10123	3	16	12/120
10125	5	19	12/120
10128	7.5	25	6/60
10129	10	25	6/60

PL Miara zwijana  
GB Measuring tape  
D Rollbandmass  
RUS Рулетка  
CZ Měřicí pásmo  
RO Ruleta din  
H Mérőszalag  
E Flexometro



**VOREL**

No.	L (m)	W (mm)	
11603	3	16	12/120
11605	5	19	12/120
11608	8	25	6/60

PL Miara zwijana stalowa  
GB Steel measuring tape  
D Rollbandmass  
RUS Мерная лента стальная



**VOREL**

No.	L (m)	W (mm)	
12502	20	10	6/30
12503	30	10	6/30

PL Taśma miernicza z włókna szklanego  
GB Fibreglass measuring tape  
D Rollbandmass  
RUS Мерная лента фиброглассовая

CZ Měřicí pásmo /skleněné vlákno/  
RO Ruleta fibra sticla  
H Mérőszalag /üvegszál/  
E Cinta de medir /fibra cristal/



No.	L (m)	packing	
14100	10		20/100
14200	20		12/60
14300	30		12/60
14500	50		10/30

PL Miara drewniana, składana, okuta  
 GB Wooden folding rule  
 D Gliedemasstab  
 RUS Метр складной деревянный

CZ Měřicí pásmo dřevěné skladané /okované/  
 RO Metru tamplar lemn  
 H Fa colstok /vasalt/  
 E Metro de madera, plegable /articulado/



No.	L (m)	
15010	1	24/480
15020	2	12/240

PL Miara drewniana, składana, okuta  
 GB Wooden folding rule  
 D Gliedemasstab  
 RUS Метр складной деревянный

CZ Měřicí pásmo dřevěné skladané /okované/  
 RO Metru tamplar lemn  
 H Fa colstok /vasalt/  
 E Metro de madera, plegable /articulado/



No.	type	L (m)	
15005	PERFECT B	1	20/200
15007	PERFECT B	2	10/100

PL Miara plastikowa  
 GB Plastic folding rule  
 D Kunststoffgliedemasstab  
 RUS Метр складной пластмассовый

CZ Měřicí pásmo plastové skladané  
 RO Metru de plastic  
 H Műanyag, összecskukható mérce  
 E Metro de plástico, plegable



No.	L (m)	
15050	1	20/200
15070	2	12/120

PL Suwmiarka  
 GB Vernier caliper  
 D Messschieber  
 RUS Штангенциркуль

CZ Posuvné měřtko  
 RO Subler  
 H Tolómérő  
 E Calibre



No.	L (mm)	mm	packing	
15100	150	0.05		40
15110	150	0.02		10/100

PL Miara drewniana, składana, okuta  
 GB Wooden folding rule  
 D Gliedemasstab  
 RUS Метр складной деревянный

CZ Měřicí pásmo dřevěné skladané /okované/  
 RO Metru tamplar lemn  
 H Fa colstok /vasalt/  
 E Metro de madera, plegable /articulado/

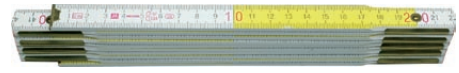

No.	type	L (m)	
15004	PERFECT B-Ž	1	20/200
15006	PERFECT B-Ž	2	10/100

PL Miara składana  
 GB Folding rule  
 D Klappbares Massband  
 RUS Метр складной

CZ Měřicí pásmo skladané  
 RO Metru armat  
 H Famérce  
 E Metro plegable



No.	L (m)	W (mm)	
15071	1	13	10/200

PL Szczelinomierz  
 GB Feeler  
 D Fühlerlehre  
 RUS Щупы автомобильные

CZ Spároměr  
 RO Lere  
 H Hézagmérő  
 E Calibre de fisuras



No.	mm	pcs	
15130	0.05-1.00	13	15/300
15200	0.05-1.00	20	10/200

PL Suwmiarka zegarowa  
 GB Dial caliper  
 D Präzisions-Uhrmessschieber  
 RUS Штангенциркуль стрелочный

CZ Posuvné měřtko hodinové  
 RO Subler cu cadran  
 H Órás tolómérő  
 E Calibre dial



No.	L (mm)	mm	
15220	150	0.02	10/50

PL Suwmiarka elektroniczna  
GB Digital caliper  
D Digital Messschieber  
RUS Штангенциркуль электронный

CZ Posuvné měřítko elektronické  
RO Şubler electronic  
H Elektronikus tolómérő  
E Calibre electrónico



**VOREL**

No.	L (mm)	mm	
15240	150	0.03	10/50

PL Sznur traserski  
GB Chalk line  
D Schnurlot  
RUS Шнур-отвес малярный

CZ Orýšováci šňúra  
RO Şnur de trasat  
H Kicsapózsínor  
E Cordel tizador



**VOREL**

No.	L (m)	
17501	15	10/100

PL Kreda traserska  
GB Blue / red chalk  
D Kreide blau / rot  
RUS Краска для шнура

CZ Křída trasovací  
RO Praf de creta pt. trasat  
H Jelölő krétapor  
E Tiza azul/rojo



**VOREL**

No.	g	colour / kolor	
17507	115		20/80
17508	115		20/80

PL Sznurek murarski  
GB Builders line  
D Maurerschnur  
RUS Шнур каменщика  
CZ Šňúra zednická  
RO Sfoară pt. zidari  
H Kőműves zsinór  
E Cuerda de albañil



**VOREL**

No.	L (m)	
17495	75	12/48

PL Sznur traserski  
GB Chalk line  
D Schnurlot  
RUS Шнур-отвес малярный

CZ Orýšováci šňúra  
RO Şnur de trasat  
H Kicsapózsínor  
E Cordel tizador



No.	L (m)	
17500	15	10/100

PL Sznur traserski z kredą niebieską  
GB Chalk line & blue chalk  
D Schlagschnur mit Kreide  
RUS Шнур-отвес малярный + краска

CZ Orýšováci šňúra  
RO Fir trasare si praef de creta albastra  
H Kicsapózsínor  
E Cordel tizador con tiza azul



**VOREL**

No.	L (m)	g	
17505	15	115	10/60

PL Sznurek murarski  
GB Builders line  
D Maurerschnur  
RUS Шнур - причалка

CZ Šňúra zednická  
RO Sfoară pt. zidari  
H Kőműves zsinór  
E Cuerda de albañil



No.	L (m)	
17490	40	80

PL Sznurek murarski  
GB Builders line  
D Maurerschnur  
RUS Шнур каменщика

CZ Šňúra zednická  
RO Sfoară pt. zidari  
H Kőműves zsinór  
E Cuerda de albañil



No.	L (m)	colour / kolor	
17488	50		60
17489	100		60

**PL** Sznurek murarski, polipropylenowy  
**GB** Polypropylene bricklayer's string  
**D** Maurerschnur aus Polypropylen  
**RUS** Шнур каменщика

**CZ** Šňůra zednická polypropylenová  
**RO** Șnur de zidărie din polietilena  
**H** Kőműves zsinór, polipropilén  
**E** Cordel de albañilería



**VOREL**

No.	Ø (mm)	L (m)	
17470	1.7	50	60/240
17471	1.7	100	30/120
17473	2.0	50	60/240
17474	2.0	100	30/120

**PL** Linka pleciona polipropylenowa  
**GB** Polypropylene sennit line  
**D** Geflochtenes Seil aus Polypropylen  
**RUS** Канат полипропиленовый плетеный

**CZ** Lano pletené polypropylenové  
**RO** Coarda împletită din polipropilena  
**H** Polipropilén fonott kötél  
**E** Cuerda trenzada de polipropileno



**VOREL**

No.	Ø (mm)	L (m)	
69502	4	400	4
69503	5	250	4
69504	6	250	4
69505	8	300	2
69506	10	200	2
69493	12	20	15
69507	12	180	1
69508	14	110	1
69509	16	80	1
69510	18	70	1

**PL** Lina jutowa skręcana  
**GB** String jute rope  
**D** Verdrillt seil aus Jute  
**RUS** Канат джутовый

**CZ** Lano jutová kroucená  
**RO** Cablu răsucit de iută  
**H** Juta sodrott kötél  
**E** Cable de yute torcido



**VOREL**

No.	Ø (mm)	L (m)	
69572	10	10	40
69602	40	20	1

**PL** Sznurek murarski polietylenowy  
**GB** Polyethylene bricklayer's string  
**D** Maurerschnur aus Polyäthylen  
**RUS** Полиэтиленовый шнур каменщика

**CZ** Šňůra zednická polyetylenová  
**RO** Șnur de zidărie din polietilena  
**H** Kőműves zsinór, polietilén  
**E** Cordel de albañilería de polietileno



**VOREL**

No.	Ø (mm)	L (m)	
17480	1.7	50	60/240
17481	1.7	100	30/120
17483	2.0	50	60/240
17484	2.0	100	30/120

**PL** Linka pleciona polipropylenowa  
**GB** Polypropylene sennit line  
**D** Geflochtenes Seil aus Polypropylen  
**RUS** Канат полипропилен

**CZ** Lano pletené polypropylenové  
**RO** Coarda împletită din polipropilena  
**H** Polipropilén fonott kötél  
**E** Cuerda trenzada de polipropileno



**VOREL**

No.	Ø (mm)	L (m)	
69521	4	20	50

**PL** Sznurek PP pleciony, uniwersalny  
**GB** Universal PP sennit string  
**D** PP-Schnur, geflochten, universell  
**RUS** Шнур полипропиленовый

**CZ** Šňůra PP pletená univerzální  
**RO** Șnur PP împletit, universal  
**H** PP fonott kötél, univerzális  
**E** Cordel trenzado universal PP



**VOREL**

No.	Ø (mm)	L (m)	
69620	3	10	50
69621	3	20	40

**PL** Sznurek pakowy, jutowy  
**GB** Packing jute string  
**D** Packschnur, aus Jute  
**RUS** Шнур джутовый

**CZ** Šňůra ucpávková jutová  
**RO** Șnur de împachetat, de iută  
**H** Csomagkötőző spárga, juta  
**E** Cordel de yute para embalaje



**VOREL**

No.	dkg	
69630	5	112
69631	10	100

- PL Nici lniane, dratwa  
 GB Flax thread, twine  
 D Leinenfaden, Pechfaden  
 RUS Нить (дратва) льняная
- CZ Níť lněná, dratev  
 RO Fire de in, fire  
 H Len céma, fonál  
 E Hilo de lino, cabo de zapatero



No.	dkg	
69635	10	28
69637	25	18

- PL Sznurek PP do podwizywania wetny izolacyjnej  
 GB Spliced wire polypropylene string  
 D Polypropylen emtegar  
 RUS Шнур полипропиленовый  
 CZ Provázek polypropylenový  
 RO Snur din polipropilena  
 H Špagát polypropylénový  
 E Cuerda



No.	Ø (mm)	L (m)	
69608	2.5	200	100
69609	2.5	300	80
69610	2.5	450	50
69612	2.5	1000	24
69613	2.5	2000	12

- PL Pion murarski  
 GB Plumb bob  
 D Senklot  
 RUS отвес со шнуром
- CZ Murařská ceznice  
 RO Fir cu plumb  
 H Kőmívés függőn  
 E Plomada albañil



No.	size / rozmiar (mm)	
17300	15x70	200

- PL Kałownik stolarski  
 GB Try square  
 D Zimmermannswinkel  
 RUS Угольник столярный
- CZ Truhlářský úhelník  
 RO Echer (unghi drept) de tâmplărie  
 H Asztalos derékszög  
 E Escuadra de metalo



No.	mm	
18201	200x300	24/48
18200	400x600	12/24

- PL Lina igłowa  
 GB Needle rope  
 D Nadelseil  
 RUS Канат полипропиленовый, плетёный
- CZ Lano s jádrem opletené  
 RO Cablu ac  
 H Tűfontatos kötél  
 E Cable acalabrotado



No.	Ø (mm)	L (m)	
69539	8	10	30
69540	8	20	20
69542	10	10	25
69543	10	20	15
69546	12	20	10

- PL Linka pleciona, elastyczna  
 GB Elastic sennit line  
 D Geflochtenes Seil, elastisch  
 RUS Канат плетёный эластичный
- CZ Lano pletené elastické  
 RO Coarda împletită, elastică  
 H Fonott kötél, rugalmas  
 E Cuerda trenzada elástica



No.	Ø (mm)	L (m)	
69550	6	150	1
69551	8	100	1
69552	10	100	1

- PL Kałownik stolarski  
 GB Try square  
 D Zimmermannswinkel  
 RUS Угольник столярный
- CZ Truhlářský úhelník  
 RO Echer (unghi drept) de tâmplărie  
 H Asztalos derékszög  
 E Escuadra de metalo



No.	mm	
18250	250	12/120
18300	300	12/120
18350	350	12/120

- PL Kałownik aluminiowy  
 GB Aluminium try square  
 D Alu-Zimmermannswinkel  
 RUS Угольник столярный алюминиевый
- CZ Truhlářský úhelník  
 RO Echer (unghi drept) de tâmplărie  
 H Asztalos derékszög  
 E Escuadra



No.	mm	
18360	250	10/60
18361	300	10/60
18362	350	10/60

- PL Kątownik z podpórką  
GB Angle bar with a support  
D Winkel mit Stütze  
RUS Угольник столярный с откидным упором

- CZ Úhelník s dorazem  
RO Cornier cu stand  
H Támaszos derékszögelő  
E Escuadra con soporte



No.	mm	☐
18501	350	30
18502	500	30
18503	750	20
18504	1000	10

- PL Skońnica drewniana  
GB Bevel protractor  
D Schmiege  
RUS Угольник регулируемый деревянный

- CZ Nastavitelný úhloměr  
RO Echer reglabil  
H Állítható szögmérő  
E Calibrador de biseles



No.	mm	☐
18800	270	80
18810	400	60

- PL Przymiarz aluminiowy, uchwyt, 2 libelki  
GB Aluminium ruler, 2 vials  
D Alu zeichen-massstab 2-lib  
RUS Линейка столовая алюминиевая 2 глазка с ручкой

- CZ Měřidlo hliníkové  
RO Rigla de aluminiu cu 2 bule  
H Alumínium vonalzó  
E Regla de aluminiu, mango, division 2-burbujas



No.	mm	vials / libelki	☐
19770	600	2	12/24

- PL Wykrywacz metalu i przewodów  
GB Metal and voltage detector  
D Ortungsgerät für metal und leitungen  
RUS Детектор металла и проводки

- CZ Metalo ir átampas detektorius  
RO Detector metale / electricitate  
H Fém- és feszültség detektor  
E Detector de metalo y cables



No.	☐
81781	20

- PL Kątomierz nastawny  
GB Bevel protractor  
D Winkelmesser  
RUS Угломер регулируемый со шкалой

- CZ Nastavitelný úhloměr  
RO Echer reglabil  
H Állítható szögmérő  
E Calibrador de biseles



No.	mm	☐
18797	350	10
18798	500	10
18799	750	10

- PL Przymiarz budowlany  
GB Carpenter's ruler  
D Zeichen-massstab  
RUS Линейка стальная с деревянной ручкой

- CZ Měřidlo stavební  
RO Rigla de tamplarie  
H Kőműves vonalzó  
E Regla de obra



No.	mm	☐
19750	750	10/40

- PL Dalmierz ultradźwiękowy z laserem  
GB Ultrasonic distance meter with laser  
D Ultraschall Entfernungsmesser mit Laserpointer  
RUS Ультразвуковой измеритель расстояния  
CZ Ultrazvukový měřič vzdáleností  
RO Aparat masurat distanta cu laser  
H Léyeres, ultrahangos távolságmérő  
E Distanciómetro de ultrasonido con láser

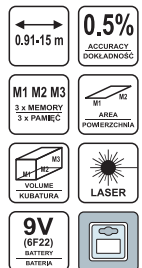

No.	↔ m	battery / bateria	☐
81782	0.91-15	9V (6F22)	6/36

- PL Wykrywacz metalu i przewodów  
GB Metal and voltage detector  
D Ortungsgerät für metal und leitungen  
RUS Детектор металла и проводки  
CZ Metalo ir átampas detektorius  
RO Detector metale / electricitate  
H Fém- és feszültség detektor  
E Detector de metalo y cables

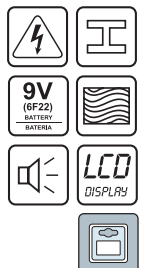

No.	battery / bateria	☐
81785	9V (6F22)	20

- PL Pirometr mini
- GB Pirometer mini
- D Pirometer Mini
- RUS Пирометр
- CZ Pyrometr mini
- RO Pirometru mini
- H Mini pirométer
- E Mini pirómetro



EMISSIVITY EMISYJNOŚĆ 0,10-1,00	-30+250 °C
BATTERY BATERIA CR2032 2 x 3V	AUTO POWER OFF WYŁĄCZANIE AUTOMATYCZNE
MAX MIN	
D:S 6:1	



No.	
81761	10/40

- PL Higrometr
- GB Hygrometer
- D Hygrometer
- RUS Гигрометр
- CZ Hygrometr
- RO Higrometru
- H Higrométer
- E Higrometro



WALL / MASONRY SCIANA / MUR	0-53% SOFTWOOD DREWNO MIĘKIE
RH%	20 mm MAX SENSE DEPTH MAKS. GŁĘBOKOŚĆ POWIERZ.
0-35% HARDWOOD DREWNO TWARDE	BATTERY BATERIA 9V(6F22)
	AUTO POWER OFF WYŁĄCZANIE AUTOMATYCZNE



No.	
81771	5/20

- PL Poziomnica aluminiowa
- GB Aluminium level
- D Wasserwaage
- RUS Уровень
- CZ Vodováha
- RO Cumpănă
- H Vízmerő
- E Nivel



No.	L (mm)	vials / libelle	
16551	400	3	25/50
16552	600	3	25/50
16553	800	3	25/50
16554	1000	3	25/50
16555	1200	3	15/30
16556	1500	3	15/30
16557	2000	3	10/20

- PL Pirometr o zmiennej emisyjności
- GB Pirometer with variable emissivity
- D Pirometer mit variabler Emissionsfähigkeit
- RUS Пирометр
- CZ Pyrometr s nastavitelnou emisivitou
- RO Pirometru cu emisivitate variabilă
- H Változó emissziójú pirométer
- E Pirómetro de emisividad variable



EMISSIVITY EMISYJNOŚĆ 0,10-1,00	-50+650 °C
BATTERY BATERIA 9V(6F22)	AUTO POWER OFF WYŁĄCZANIE AUTOMATYCZNE
MAX AVG MIN DIFF	
D:S 12:1	10 MEASUREMENT MEMORY PERFECT POMIARU



No.	
81762	5/20

- PL Poziomnica aluminiowa
- GB Aluminium level
- D Wasserwaage
- RUS Уровень
- CZ Vodováha
- RO Cumpănă
- H Vízmerő
- E Nivel



No.	L (mm)	vials / libelle	
16340	400	3	20/60
16360	600	3	20/60
16380	800	3	20/60
16400	1000	3	20/60

- PL Poziomnica aluminiowa
- GB Aluminium level
- D Wasserwaage
- RUS Уровень
- CZ Vodováha
- RO Cumpănă
- H Vízmerő
- E Nivel



No.	L (mm)	vials / libelle	
17606	600	3	20/60
17608	800	3	20/60
17610	1000	3	20/60
17612	1200	3	15/30
17615	1500	3	15/30
17620	2000	3	10/20

- PL Poziomnica wodna z węzłem
- GB Water level
- D Schlauchwaage
- RUS Гидроуровень
- CZ Vodná vodováha
- RO Furtun de nivel
- H Vizes vízmerő
- E Nivel de agua



No.	L (m)	size / rozmiar (mm)	
16000	15	10	15
16001	20	10	15
16002	25	10	15



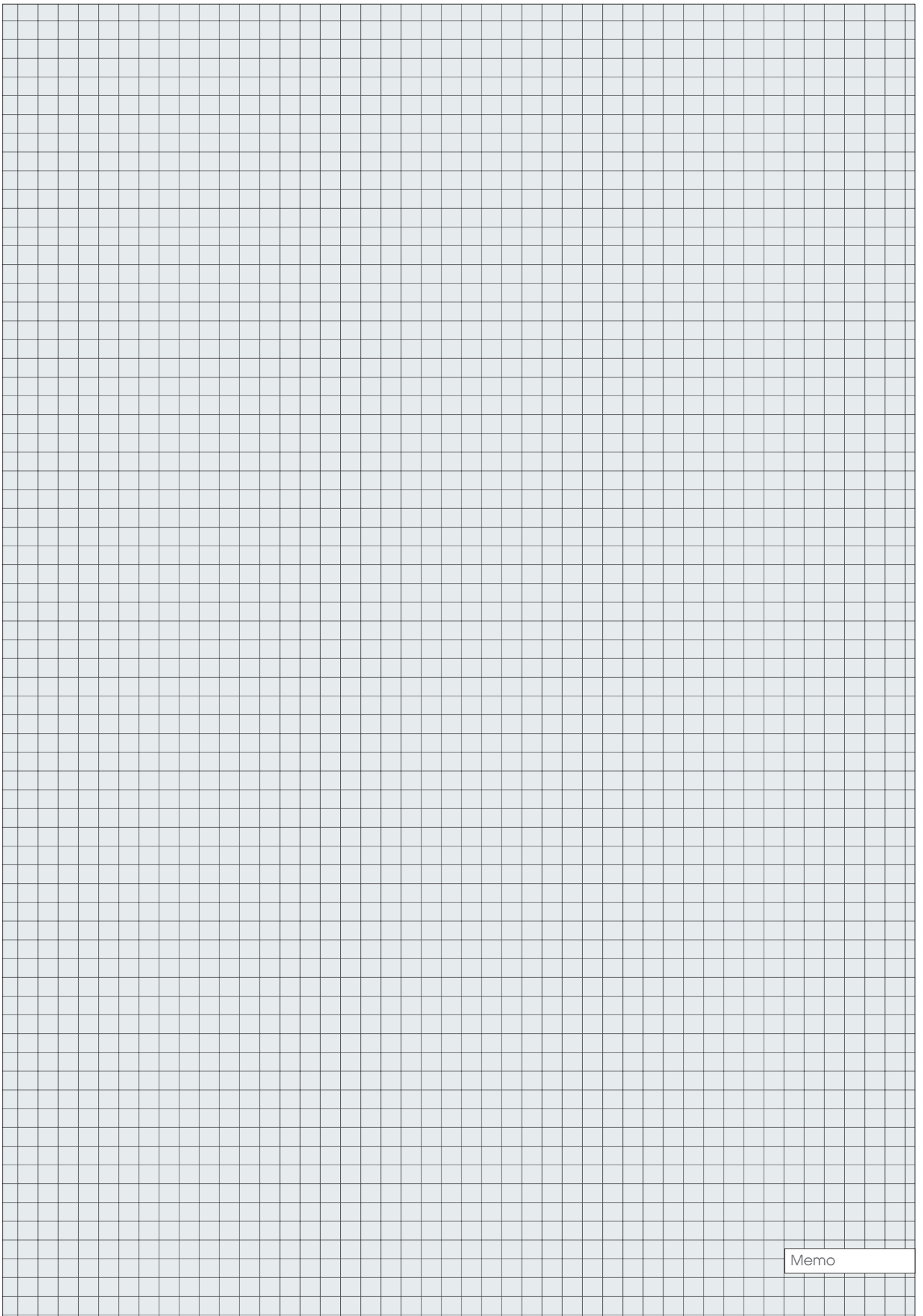

Memo

# 13

## Pneumatic tools Narzędzia pneumatyczne



**Air tools**  
**Narzędzia pneumatyczne**

170-171



<b>Impact wrenches</b> Klucze udarowe.....	170
<b>Pneumatic grinders</b> Szlifierki pneumatyczne.....	170
<b>Pneumatic ratchets</b> Grzechotki pneumatyczne.....	171
<b>Pneumatic hammers</b> Młotki pneumatyczne.....	171

**Tire inflating guns & heads**  
**Pistolety do pompowania kół i głowice**

171

**Pneumatic painting equipment**  
**Narzędzia do malowania**

172-177



<b>Spray guns</b> Pistolety lakiernicze.....	172
<b>Inflating guns</b> Pistolety do przedmuchiwania.....	173
<b>Washing guns</b> Pistolety do ropowania.....	173
<b>Pneumatic painting equipment GAV</b> Narzędzia do malowania GAV.....	173

**Pneumatic accessories**  
**Akcesoria instalacji pneumatycznej**

177-178



<b>Air filters, regulators &amp; lubricators</b> Filtry, reduktory i smarownice.....	177
<b>Spiral hoses</b> Węże spiralne.....	177
<b>Reinforced hoses</b> Węże zbrojone.....	178
<b>Couplers</b> Złącza.....	178

- PL Klucz pneumatyczny udarowy  
 GB Impact wrench  
 D Druckluft-schlagschrauber  
 RUS Гайковерт пневматический  
 CZ Klíč pneumatický  
 RO Pistol pneumatic  
 H Pneumatikus ütvecsavarozó  
 E Llave de percusión



1/4" (6.3 mm) 155 l/min  
 0-7000 min<sup>-1</sup> 0.63 MPa<sub>(max)</sub>  
 1/2" (12.5 mm) 312 Nm



$L_{pA} = 84,4 \text{ dB}; L_{wA} = 95,4 \text{ dB}; a_n = 2,6 \pm 2,0 \text{ m/s}^2$

No.	size / rozmiar	l / min	Nm	
81100	1/2" (12.5 mm)	155	312	10

- PL Szlifierka pneumatyczna prosta  
 GB Air grinder  
 D Druckluft-einhandschleifer  
 RUS Прямая пневматическая шлифмашинка  
 CZ Bruska přímá pneumatická  
 RO Polizor pneumatic  
 H Préslevegős sarokcsiszoló  
 E Lijadera neumática recta



0.63 MPa<sub>(max)</sub> 0-22000 min<sup>-1</sup> Ø6mm  
 198 l/min 1/4" (6.3 mm)



$L_{pA} = 83,5 \text{ dB}; L_{wA} = 94,5 \text{ dB}; a_n = 1,2 \pm 2,0 \text{ m/s}^2$

No.	size / rozmiar	l / min	min-1	
81108	1/4" (6.3 mm)	198	22000	20

- PL Szlifierka pneumatyczna prosta z akcesoriami  
 GB Die grinder kit  
 D Druckluft-Schrauber mit Schleifaufsätzen  
 RUS Прямая пневматическая шлифмашинка + принадлежности  
 CZ Bruska přímá pneumatická s příslušenstvím  
 RO Masina de polizat pneumatica  
 H Pneumatikus kőszűrő készlet  
 E Lijadera neumática recta



0.63 MPa<sub>(max)</sub> 0-22000 min<sup>-1</sup> 1/4" (6.3 mm)  
 198 l/min Ø3,6mm 10 pcs



$L_{pA} = 83,5 \text{ dB}; L_{wA} = 94,5 \text{ dB}; a_n = 1,2 \pm 2,0 \text{ m/s}^2$

No.	size / rozmiar	l / min	min-1	
81109	1/4" (6.3 mm)	198	22000	8

- PL Klucz pneumatyczny z nasadkami  
 GB Air impact kit  
 D Druckluft - schlagschrauber mit Kräfteinsätzen  
 RUS Гайковерт пневматический + набор головок  
 CZ Klíč pneumatický s nástavci  
 RO Pistol pneumatic cu accesorii  
 H Pneumatikus ütvecsavarozó készlet  
 E Llave neumático de percusión



9 10 11 13 14 17 19 22 24 27 mm  
 0.63 MPa<sub>(max)</sub> 0-7000 min<sup>-1</sup>  
 312 Nm 1/2" (12.5 mm)  
 1/4" (6.3 mm) 1/2" (12.5 mm) 12.5 mm  
 155 l/min CrV  
 MINI OILER OIL POT



$L_{pA} = 84,4 \text{ dB}; L_{wA} = 95,4 \text{ dB}; a_n = 2,6 \pm 2,0 \text{ m/s}^2$

No.	size / rozmiar	l / min	Nm	
81101	1/2" (12.5 mm)	155	312	5

- PL Szlifierka pneumatyczna kątowa  
 GB Air angle grinder  
 D Druckluft-Winkelschleifer  
 RUS Угловая шлифовальная машинка  
 CZ Bruska úhlová vzduchová  
 RO Polizor pneumatic  
 H Préslevegős sarokcsiszológép  
 E Lijadera neumática de angulo



1/4" (6.3 mm) 113 l/min Ø6mm  
 0-20000 min<sup>-1</sup> 0.63 MPa<sub>(max)</sub>



$L_{pA} = 90,1 \text{ dB}; L_{wA} = 101,1 \text{ dB}; a_n = 0,7 \text{ m/s}^2$

No.	size / rozmiar	l / min	min-1	
81110	1/4" (6.3 mm)	113	20000	16

- PL Szlifierka pneumatyczna mimośrodowa  
 GB Air sander  
 D Druckluft- Excenterschleifer  
 RUS Эксцентриковая шлифмашинка  
 CZ Bruska pneumatická  
 RO Masina de slefuit pneumatica  
 H Pneumatikus sarokcsiszológép  
 E Lijadera neumática excentrica



0.63 MPa<sub>(max)</sub> 0-10000 min<sup>-1</sup>  
 113 l/min 150 Ø (mm)  
 1/4" (6.3 mm)



$L_{pA} = 72,7 \text{ dB}; L_{wA} = 83,7 \text{ dB}; a_n = 1,44 \text{ m/s}^2$

No.	size / rozmiar	Ø (mm)	MPa	
81114	1/4" (6.3 mm)	150	0.63	10

- PL Tarcza polerska do szlifierki pneumatycznej
- GB Disc for air sander
- D Stützteller für Druckluftexcenterschleifer
- RUS Диск для эксцентриковой шлифмашины
- CZ Disk pro pneumatickou brusku
- RO Masina disc pt. slefuit
- H Csiszolókorong pneumatikus gépekhez
- E Recambio disco lijadora orbital neumatica



Ø [mm]  
**150**

0-10000 min<sup>-1</sup> max.

**M8**



No.	Ø (mm)	min-1	
81115	150	0-10000	10/100

- PL Grzechotka pneumatyczna
- GB Ratchet air wrench
- D Druckluft-Ratschenschrauber
- RUS Пневмотрещотка
- CZ Utahovák vzduchový
- RO Antrenor pneumatic
- H Préslevegős behajtó szerszám
- E Carraca neumática

1/2" 0.63 141  
12.5 mm MPa(max) l/min

0-160 min<sup>-1</sup> 68 Nm 1/4" 6.3 mm



No.	size / rozmiar	l / min	Nm	
81118	1/2" (12.5 mm)	141	68	10

- PL Młotek pneumatyczny
- GB Air hammer
- D Druckluft-schlaghammer
- RUS Пневматический молоток
- CZ Sekáč vzduchový
- RO Pneumaticus vésőkészlet pisztollyal
- H Klado pneumatické
- E Marteau burineur

1/4" 0.63  
6.3 mm MPa(max)

T 113  
4500 min<sup>-1</sup> l/min



No.	size / rozmiar	l / min	
81133	1/4" (6.3 mm)	113	8

- PL Pistolet do pompowania z manometrem
- GB Tire-inflating gun
- D Reifenfüller mit manometer
- RUS Пистолет для накачки шин с манометром
- CZ Pistole na čerpání z manometrem
- RO Pistol de aer pt. pneuri cu manometru
- H Nyomásmérő tehergépkocsikhoz
- E Pistola de bombeo con manometro

**2.8-10 bar**



No.	bar	
81650	2.8-10	10/40

- PL Grzechotka pneumatyczna
- GB Ratchet air wrench
- D Druckluft-Ratschenschrauber
- RUS Пневматический гаечный ключ с трещоткой
- CZ Utahovák vzduchový
- RO Antrenor pneumatic
- H Préslevegős behajtó szerszám
- E Carraca neumática

0.63 0-150 61  
MPa(max) min<sup>-1</sup> Nm

141 1/2" 1/4"  
l/min 12.5 mm (6.3 mm)



LpA = 90,8 dB; LwA = 101,8 dB; ah = 1,2 ± 2,0 m/s<sup>2</sup>

No.	size / rozmiar	l / min	Nm	
81117	1/2" (12.5 mm)	141	61	20

- PL Zestaw narzędzi pneumatycznych z akcesoriami
- GB Pneumatic tool set
- D Druckluftwerkzeugsatz mit zubehör
- RUS Пневматический ударный инструмент в наборе
- CZ Sada pneumatického nářadí
- RO Set pistol + accesorii pneumatice
- H Lúgszersámok készlet
- E Juego de herramientas neumáticas con accesorios

312 Nm 155 l/min 0-700 min<sup>-1</sup>

150 l/min 0-450 min<sup>-1</sup>

61 Nm 141 l/min 0-150 min<sup>-1</sup>

198 l/min 0-2200 min<sup>-1</sup>

1/2" 0.63 CrV  
12.5 mm MPa(max)

1/4" 6 mm MINI OILER OIL POT  
(6.3 mm)

9 10 11 13 14 17 19 22 24 27 mm



No.	size / rozmiar	Ø (mm)	pcs	
81142	1/2" (12.5 mm)	6	33	2

- PL Glowica do pompowania
- GB Inflating head
- D Klemmnippel (universal)
- RUS Насадка на насос под шланг
- CZ Hlava na čerpání
- RO Cap pt. pompă
- H Pumpafej
- E Cabeza de bombeo

**2.8-10 bar**

BRASS MOSIADZ

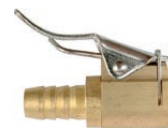

No.	mm	bar	
81653	8	2.8-10	50/300
81661	6	2.8-10	50/300

- PL Pistolet natryskowy
- GB Spray gun with fluid cup
- D Lackierpistole mit Fliessbecher
- RUS Краскораспылитель нижний металлический бачок
- CZ Pistole na lakování z nádrží
- RO Pistol de vopsit cu rezervor inferior
- H Festőpisztoly alsó tartállyal
- E Pistola de barniz



L<sub>pa</sub> = 61,2 dB; L<sub>wa</sub> = 72,2 dB

No.	Ø (mm)	Box
80901	1.4	10

- PL Pistolet natryskowy
- GB Spray gun with fluid cup
- D Lackierpistole mit Fliessbecher
- RUS Краскораспылитель нижний металлический бачок
- CZ Pistole na lakování z nádrží
- RO Pistol de vopsit cu rezervor inferior
- H Festőpisztoly alsó tartállyal
- E Pistola de barniz



No.	Ø (mm)	Box
81617	1.5	20

- PL Zestaw lakierniczy
- GB Spray gun kit
- D Lackierspritzsatz
- RUS Набор покрасочный пневматический

- CZ Laková souprava
- RO Set de lacuit
- H Részcs fényezőkészlet
- E Juego de barniz



13

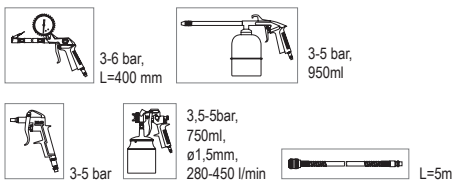

No.	pcs	Box
81637	5	10

- PL Pistolet natryskowy
- GB Spray gun with fluid cup
- D Lackierpistole mit Fliessbecher
- RUS Краскораспылитель верхний бак
- CZ Pistole na lakování z nádrží
- RO Pistol de vopsit cu rezervor inferior
- H Festőpisztoly alsó tartállyal
- E Pistola de barniz



L<sub>pa</sub> = 58,2 dB; L<sub>wa</sub> = 69,2 dB

No.	Ø (mm)	Box
80902	1.4	10

- PL Pistolet natryskowy
- GB Spray gun with fluid cup
- D Lackierpistole mit Fliessbecher
- RUS Краскораспылитель верхний бак
- CZ Pistole na lakování z nádrží
- RO Pistol de vopsit cu rezervor inferior
- H Festőpisztoly alsó tartállyal
- E Pistola de barniz



No.	Ø (mm)	Box
81618	1.5	20

- PL Zestaw lakierniczy
- GB Spray gun kit
- D Lackierspritzsatz
- RUS Набор покрасочный пневматический

- CZ Laková souprava
- RO Set de lacuit
- H Részcs fényezőkészlet
- E Juego de barniz

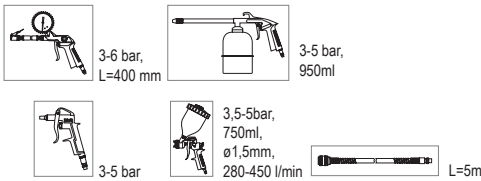

No.	pcs	Box
81638	5	10

- PL Pistolet do przedmuchiwania  
 GB Inflating gun  
 D Ausblaspistole  
 RUS Пистолет для продувки короткий
- CZ Pistole na profukování kratká  
 RO Pistol scurt pt. suflat  
 H Rövid előlefvű pisztoly  
 E Pistola de soplado

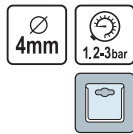

No.	bar	
81640	1.2-3	20/40

- PL Pistolet do ropowania  
 GB Washing gun  
 D Waschpistole  
 RUS Пистолет для нефтявания
- CZ Pistole na ropování  
 RO Pistol (dozor) pt. motorină  
 H Olajópisztoly  
 E Pistola de petroleaz



No.	bar	
81647	3-5	10/20

- PL Pistolet natryskowy  
 GB Spray gun with fluid cup  
 D Lackierpistole mit Fliessbecher  
 RUS Краскораспылитель верхний бак  
 CZ Pistole na lakování z nádrží  
 RO Pistol de vopsit cu rezervor inferior  
 H Festópisztoly alsó tartályal  
 E Pistola de barniz



No.	cm <sup>3</sup>	bar	
GV-0062	750	4-8	20

- PL Pistolet do przedmuchiwania  
 GB Inflating gun with extension  
 D Gebläsepistole mit Verlängerung  
 RUS Пистолет для продувки (короткий)
- CZ Pistole na profukování dlouhá  
 RO Pistol lung pt. suflat  
 H Rövid előlefvű pisztoly  
 E Pistola de soplado



No.	bar	
GV-0400	12	100

- PL Pistolet do przedmuchiwania z przedłużką  
 GB Inflating gun with extension  
 D Gebläsepistole mit Verlängerung  
 RUS Пистолет для продувки длинный

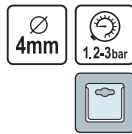

No.	bar	
81644	1.2-3	20/40

- PL Pistolet natryskowy  
 GB Spray gun with fluid cup  
 D Lackierpistole mit Fliessbecher  
 RUS Краскораспылитель верхний бак  
 CZ Pistole na lakování z nádrží  
 RO Pistol de vopsit cu rezervor inferior  
 H Festópisztoly alsó tartályal  
 E Pistola de barniz



No.	cm <sup>3</sup>	bar	
GV-0083	1000	4-8	20

- PL Pistolet natryskowy  
 GB Spray gun with fluid cup  
 D Lackierpistole mit Fliessbecher  
 RUS Краскораспылитель нижний металлический бачок  
 CZ Pistole na lakování z nádrží  
 RO Pistol de vopsit cu rezervor inferior  
 H Festópisztoly alsó tartályal  
 E Pistola de barniz



No.	cm <sup>3</sup>	bar	
GV-0082	1000	4-8	20

- PL Pistolet do przedmuchiwania  
 GB Inflating gun with extension  
 D Gebläsepistole mit Verlängerung  
 RUS Пистолет для продувки длинный
- CZ Pistole na profukování dlouhá  
 RO Pistol lung pt. suflat  
 H Rövid előlefvű pisztoly  
 E Pistola de soplado



No.	bar	
GV-0420	12	200

- PL Pistolet do ropowania  
 GB Washing gun  
 D Waschpistole  
 RUS Пистолет для нефтявания
- CZ Pistolet na ropování  
 RO Pistol (dozor) pt. motorină  
 H Olajópisztoly  
 E Pistola de petroleur



No.	bar	
GV-0510	12	18

- PL Pistolet do pompowania z manometrem  
 GB Tire-inflating gun  
 D Reifenfüller manometer  
 RUS Пистолет для накачки шин с манометром
- CZ Pistolet na čerpání z manometrem  
 RO Pistol presiune cu manometru  
 H Indicator de presiune pt. camioane  
 E Pistola de bombeo con manometro



No.	bar	
GV-0620	10	100

- PL Głowica do pompowania  
 GB Universal head  
 D Klemmnippel (universal)  
 RUS Насадка на насос под шланг
- CZ Hlava na čerpání  
 RO Cap pt. pompă  
 H Pumpafej  
 E Cabeza de bombeo



No.	Ø (mm)	
GV-0656	6	500/1500
GV-0658	8	250/1000

- PL Pistolet do piaskowania z węzłem  
 GB Air sand blaster  
 D Pistole zum sandstrahlen  
 RUS Пескоструйный пистолет
- CZ Pískovací pistole s hadicí  
 RO Pistol de sablat  
 H Homokszóró pisztoly tömlővel  
 E Pistola para limpieza con chorro de arena con manguera



No.	bar	m	
GV-0710	6-8	2	50

- PL Pistolet do pompowania z manometrem  
 GB Tire-inflating gun  
 D Reifenfüller manometer  
 RUS Пистолет для накачки шин с манометром
- CZ Pistolet na čerpání z manometrem  
 RO Pistol presiune cu manometru  
 H Indicator de presiune pt. camioane  
 E Pistola de bombeo con manometro



No.	bar	
GV-0610	12	100

- PL Pistolet do pompowania z manometrem  
 GB Tire-inflating gun  
 D Reifenfüller manometer  
 RUS Пистолет для накачки шин с манометром
- CZ Pistolet na čerpání z manometrem  
 RO Pistol presiune cu manometru  
 H Indicator de presiune pt. camioane  
 E Pistola de bombeo con manometro



No.	bar	
GV-0631	12	25

- PL Pistolet do piaskowania ze zbiornikiem  
 GB Gun suitable for sand-blasting  
 D Sandstrahlpistole  
 RUS Пескоструйный пистолет
- CZ Pískovací pistole se zásobníkem  
 RO Pistol de sablat  
 H Homokszóró pisztoly tartályal  
 E Pistola para limpieza con chorro de arena con recip.



No.	cm³	bar	
GV-0700	1000	6-8	100

- PL Pistolet do konserwacji  
 GB Gun for sound-deadening treatments  
 D Spitzpistole für flächenschutzfluide  
 RUS Пистолет для консервирования
- CZ Konzervační pistole  
 RO Pistol pt. întreținere  
 H Karbantartó pisztoly  
 E Pistola de conservar con recipiente



No.	cm³	bar	
GV-0720	1000	6-8	100



- PL Pistolet do konserwacji  
 GB Gun for protection and sound-roofing treatments  
 D Spitzpistole für flächenschutzfluide  
 RUS Пистолет для консервирования
- CZ Konzervační pistole  
 RO Pistol pt. întreținere  
 H Karbantartó pisztoly  
 E Pistola de conservar sin recipiente



No.	bar	
GV-0730	6-8	100

- PL Filtr - reduktor  
 GB Filter - reducer  
 D Druckfilter - druckminderer  
 RUS Фильтр - редуктор
- CZ Filtr derukční ventil  
 RO Filtru cu reductor  
 H Szűrő - nyomásszabályzó  
 E Reductor + filtro



No.	max bar	size / rozmiar	
GV-0861	16	1/2" (12.5 mm)	20

- PL Reduktor ciśnienia z manometrem  
 GB Pressure reducing valve with manometer  
 D Druckminderer mit manometer  
 RUS Регулятор давления с манометром
- CZ Redukční ventil s manometrem  
 RO Valva cu reductiepresiune + manometru  
 H Nyomáscsökkentő szelep nyomásmérővel  
 E Reductor + manometro



No.	max bar	
GV-0925	12	100

- PL Szybkozłącze  
 GB Quick coupler  
 D Schnellkupplung  
 RUS Быстроразъемное соединение на шланг
- CZ Rychlospojka  
 RO Mufa rapida pt. pistol pneumatic  
 H Gyorscsatlakozó  
 E Conexión de la entrada de aire

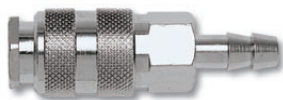

No.	Ø (mm)	
GV-1121	6	100/300
GV-1122	8	100/300
GV-1123	10	100/300

- PL Pistolet do konserwacji z węzłem  
 GB Gun for protection and sound-roofing treatments  
 D Spitzpistole für flächenschutzfluide  
 RUS Пистолет для консервирования
- CZ Konzervační pistole s hadicí  
 RO Pistol pt. întreținere, cu furtun  
 H Karbantartó pisztoly tömlővel  
 E Pistola de conservar sin recipiente con manguera



No.	bar	
GV-0740	6-8	75

- PL Zespół filtrujący, reduktor + smarownica  
 GB Air filter regulator and lubricator  
 D Druckfilter-druckminderer - Entöler  
 RUS Фильтр-редуктор + смазочный прибор
- CZ Redukční ventil s odlučovačem oleje  
 RO Filtru cu reductor  
 H Levegőelőkészítő  
 E Juego de filtro reductor + engrasador



No.	max bar	size / rozmiar	
GV-0871	16	1/2" (12.5 mm)	18

- PL Szybkozłącze  
 GB Quick coupler  
 D Schnellkupplung  
 RUS Быстроразъемная муфта с наружной резьбой
- CZ Rychlospojka  
 RO Mufa rapida pt. pistol pneumatic  
 H Gyorscsatlakozó  
 E Conexión de la entrada de aire



13

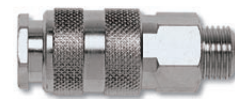

No.	size / rozmiar (M)	
GV-1100	1/4" (6.3 mm)	100/300
GV-1101	3/8" (10.0 mm)	100/300
GV-1102	1/2" (12.5 mm)	100/300

- PL Szybkozłącze  
 GB Quick coupler  
 D Schnellkupplung  
 RUS Быстроразъемное соединение с внутренней резьбой
- CZ Rychlospojka  
 RO Mufa rapida pt. pistol pneumatic  
 H Gyorscsatlakozó  
 E Conexión de la entrada de aire

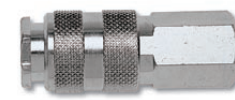

No.	size / rozmiar (F)	
GV-1105	1/4" (6.3 mm)	100/300

- PL Szybkozłącze  
GB Quick coupler  
D Schnellkupplung  
RUS Быстроразъемная муфта с наружной резьбой
- CZ Rychlospojka  
RO Mufa rapida pt. pistol pneumatic  
H Gyorscsatlakozó  
E Conexión de la entrada de aire

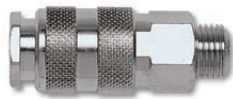

No.	size / rozmiar	
GV-1150	1/4" (6.3 mm)	100/400
GV-1151	3/8" (10.0 mm)	100/400
GV-1152	1/2" (12.5 mm)	100/400

- PL Szybkozłącze  
GB Quick coupler  
D Schnellkupplung  
RUS Быстроразъемное соединение на шланг
- CZ Rychlospojka  
RO Mufa rapida pt. pistol pneumatic  
H Gyorscsatlakozó  
E Conexión de la entrada de aire



No.	Ø (mm)	
GV-1180	6	100/400
GV-1181	8	100/400
GV-1182	10	100/400

- PL Szybkozłącze  
GB Quick coupler  
D Schnellkupplung  
RUS Быстроразъемное соединение (штуцер), внутренняя резьба
- CZ Rychlospojka  
RO Mufa rapida pt. pistol pneumatic  
H Gyorscsatlakozó  
E Conexión de la entrada de aire



No.	size / rozmiar	
GV-1220	1/4" (6.3 mm)	500/1000
GV-1221	3/8" (10.0 mm)	500/1000

- PL Gwint stożkowy  
GB Taper reducer  
D Verlängerungsrippel  
RUS Нипель 1/4"-1/4"
- CZ Vsvuka s kuželovým závitem  
RO Reductie  
H Kúpos menet  
E Junta nipel rosca cónica



No.	size / rozmiar	
GV-1272	1/4" (6.3 mm)	100/2000

- PL Szybkozłącze  
GB Quick coupler  
D Schnellkupplung  
RUS Быстроразъемное соединение с внутренней резьбой
- CZ Rychlospojka  
RO Mufa rapida pt. pistol pneumatic  
H Gyorscsatlakozó  
E Conexión de la entrada de aire

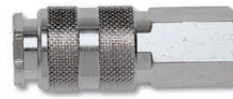

No.	size / rozmiar	
GV-1160	1/4" (6.3 mm)	100/400
GV-1161	3/8" (10.0 mm)	100/400

- PL Szybkozłącze  
GB Quick coupler  
D Schnellkupplung  
RUS Быстроразъемное соединение с наружной резьбой
- CZ Rychlospojka  
RO Mufa rapida pt. pistol pneumatic  
H Gyorscsatlakozó  
E Conexión de la entrada de aire



No.	size / rozmiar	
GV-1200	1/4" (6.3 mm)	500/2000
GV-1201	3/8" (10.0 mm)	500/1000
GV-1202	1/2" (12.5 mm)	250/1000

- PL Szybkozłącze  
GB Quick coupler  
D Schnellkupplung  
RUS Быстроразъемное соединение (штуцер), „ёлочка” с обжимным кольцом
- CZ Rychlospojka  
RO Mufa rapida pt. pistol pneumatic  
H Gyorscsatlakozó  
E Conexión de la entrada de aire



No.	Ø (mm)	
GV-1240	6	500/1500
GV-1241	8	500/2000
GV-1242	10	500/1500

- PL Złącze bagnetowe do węży  
GB Bayonet coupling for rubber pipes  
D Bajonettverschluss für gummschläuche  
RUS Переходник „ёлочка на ёлочку”
- CZ Spojky hadicové bajonetové  
RO Conector tevi  
H Bajonett csatlakozó tömlőhöz  
E Junta de bayoneta para manguera de goma



No.	Ø (mm)	
GV-1582	8	100/800
GV-1583	10	600

- PL Złącze króciec do węża  
 GB Male hose adapter  
 D Schauhülle mit aussengewinde  
 RUS Штуцер „елочка” с наружной резьбой
- CZ Spojky – nátrubek pro hadici  
 RO Adaptor furtun  
 H Csatlakozó csőcsonk tömlőhöz  
 E Junta tubo corto para manguera 6 rosca exter



No.	size / rozmiar	Ø (mm)	L (mm)	
GV-1382	1/4" (6.3 mm)	6	33	500/1500
GV-1384	1/4" (6.3 mm)	8	33	100/1000
GV-1385	3/8" (10.0 mm)	8	34	100/1000
GV-1386	3/8" (10.0 mm)	10	34	100/1200
GV-1387	1/2" (12.5 mm)	10	37	250/1000
GV-1388	1/4" (6.3 mm)	10	35	250/1000

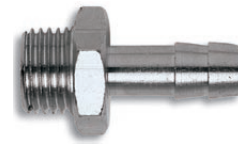

- PL Filtr  
 GB Filter  
 D Filtr  
 RUS Фильтр воздушный мини
- CZ Filtr  
 RO Minifiltru  
 H Szűrő  
 E Filtró

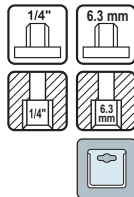

No.	size / rozmiar	
81560	1/4" (6.3 mm)	10/50

- PL Filtr - reduktor  
 GB Filter - reducer  
 D Druckfilter - druckminderer  
 RUS Фильтр - редуктор
- CZ Filtr redukční ventil  
 RO Filtru cu reduktor  
 H Szűrő - nyomáscsökkentő  
 E Reductor + filtro

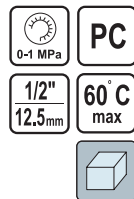

No.	size / rozmiar	
81553	1/2" (12.5 mm)	20

- PL Wąż spiralny PE z szybkozłączami  
 GB PE spiral tubes with rapid couplings  
 D Spiralschlauch mit Schnellkupplung  
 RUS Шланг спиральный с быстроразъемным соединением
- CZ Spirální hadice  
 RO Furtun în spirală  
 H Spiráltömlő  
 E Manguera espiral



No.	mm	L (m)	
81490	5x8	5	50
81491	5x8	10	25
81492	5x8	15	25

- PL Reduktor ciśnienia z manometrem  
 GB Pressure reducing valve with manometer  
 D Druckminderer mit manometer  
 RUS Регулятор давления с манометром
- CZ Redukční ventil s manometrem  
 RO Valva cu reduciēpresune + manometru  
 H Nyomáscsökkentő szelep nyomásmérővel  
 E Reductor + manometro



No.	size / rozmiar	
81562	3/8" (10.0 mm)	50

- PL Zespół filtrujący, reduktor + smarownica  
 GB Air filter regulator and lubricator  
 D Druckfilter-druckminderer - Entöler  
 RUS Фильтр-редуктор + смазочный прибор
- CZ Redukční ventil s odlučovačem oleje  
 RO Filtru cu reduktor  
 H Levegőelőkészítő  
 E Juego de filtro reductor + engrasador

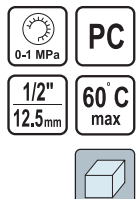

No.	size / rozmiar	
81556	1/2" (12.5 mm)	20

- PL Wąż spiralny PU z szybkozłączami  
 GB PU spiral tubes with rapid couplings  
 D Spiralschlauch mit Schnellkupplung  
 RUS Шланг спиральный с быстроразъемным соединением
- CZ Spirální hadice  
 RO Furtun în spirală  
 H Spiráltömlő  
 E Manguera espiral



No.	mm	L (m)	
81500	5x8	5	50
81501	5x8	10	25
81502	5x8	15	25

PL Wąż zbrojony  
GB Armoured hose  
D Schlauch, verstärkt durch Bewehrung  
RUS Шланг армированный для подачи воздуха

CZ Hadice vyztužená  
RO Furtun armat  
H Fémbetétes tömlő  
E Manguera armada



No.	Ø (mm)	L (m)	wall thickness / grubość ścianki	ATM	
81519	6	50	2.5	10/40	1
81520	8	50	2.5	10/40	1
81521	10	50	2.5	10/40	1
81522	12	50	2.5	10/40	1
81523	14	50	3.0	10/40	1
81524	16	50	3.0	10/40	1
81525	19	50	3.5	10/40	1
81527	25	50	4.0	10/40	1

13

PL Szybkozłącze  
GB Quick coupler  
D Schnellkupplung  
RUS Быстроразъемное соединение на шланг

CZ Rychlospojka  
RO Mufa rapida pt. pistol pneumatic  
H Gyorscsatlakozó  
E Conexión de la entrada de aire



**VOREL**

No.	type	size / rozmiar	
81378	D	1/4" (6.3 mm)	50/250
81379	D	3/8" (10.0 mm)	50/250
81380	D	1/2" (12.5 mm)	50/250

PL Szybkozłącze  
GB Quick coupler  
D Schnellkupplung  
RUS Быстроразъемное соединение с наружной резьбой

CZ Rychlospojka  
RO Mufa rapida pt. pistol pneumatic  
H Gyorscsatlakozó  
E Conexión de la entrada de aire



**VOREL**

No.	type	size / rozmiar	
81387	D	1/4" (6.3 mm)	50/250

PL Szybkozłącze  
GB Quick coupler  
D Schnellkupplung  
RUS Быстроразъемная муфта с наружной резьбой

CZ Rychlospojka  
RO Mufa rapida pt. pistol pneumatic  
H Gyorscsatlakozó  
E Conexión de la entrada de aire



**VOREL**

No.	type	size / rozmiar	
81370	D	1/4" (6.3 mm)	50/250
81371	D	3/8" (10.0 mm)	50/250
81372	D	1/2" (12.5 mm)	50/250

PL Szybkozłącze  
GB Quick coupler  
D Schnellkupplung  
RUS Быстроразъемное соединение с внутренней резьбой

CZ Rychlospojka  
RO Mufa rapida pt. pistol pneumatic  
H Gyorscsatlakozó  
E Conexión de la entrada de aire



**VOREL**

No.	type	size / rozmiar	
81373	D	1/4" (6.3 mm)	50/250
81374	D	3/8" (10.0 mm)	50/250

PL Szybkozłącze  
GB Quick coupler  
D Schnellkupplung  
RUS Быстроразъемное соединение (штуцер), внутренняя резьба

CZ Rychlospojka  
RO Mufa rapida pt. pistol pneumatic  
H Gyorscsatlakozó  
E Conexión de la entrada de aire



**VOREL**

No.	type	size / rozmiar	
81390	D	1/4" (6.3 mm)	50/250
81391	D	3/8" (10.0 mm)	50/250

PL Szybkozłącze  
GB Quick coupler  
D Schnellkupplung  
RUS Быстроразъемное соединение (штуцер), «елочка» с обжимным кольцом

CZ Rychlospojka  
RO Mufa rapida pt. pistol pneumatic  
H Gyorscsatlakozó  
E Conexión de la entrada de aire



**VOREL**

No.	type	size / rozmiar	
81399	D	1/4" (6.3 mm)	50/250
81400	D	3/8" (10.0 mm)	50/250
81401	D	1/2" (12.5 mm)	50/250

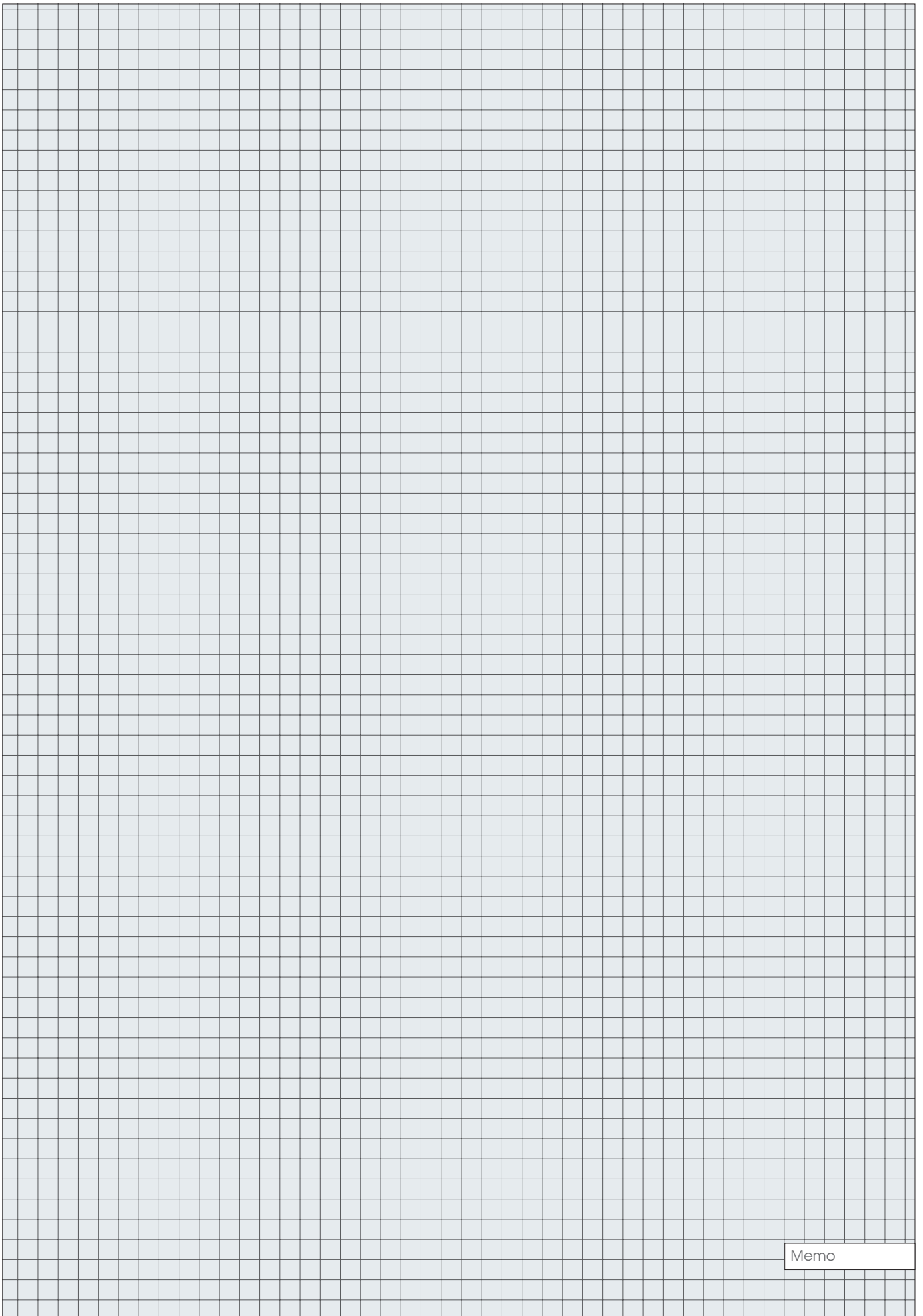

Memo

# 14

## Special automotive tools & equipment Narzędzia i wyposażenie warsztatu samochodowego



## Cabinets Szafki

182



### Roller cabinets with tools insert

Szafki serwisowe z narzędziami..... 182

### Tool cabinets

Szafki serwisowe..... 182

## Lubrication tools Narzędzia do smarowania

182-186



### Grease guns & oil transfer pumps

Smarownice ręczne i pompy transferowe do oleju..... 182

### Manual oil pumps

Pompy ręczne do oleju..... 184

### Oil cans

Oliwiarki..... 184

### Oil filter wrenches

Klucze do filtra oleju..... 185

## Pullers Ściągacze

186



### Gear pullers

Ściągacze do łożysk..... 186

### Spring pullers

Ściągacze do sprężyn..... 186

### Ball joint removers

Ściągacze do sworzni kulistych..... 186

## Workshop tools Narzędzia warsztatowe

186-194



### Wheel wrenches

Klucze do kół..... 186

### Piston ring compressors

Zaciskacze do pierścieni..... 187

### Spark plug sockets

Klucze do świec..... 187

### Flare nut wrenches

Klucze do przewodów hamulcowych..... 188

### Car voltage testers

Samochodowe próbniki napięcia..... 188

### Magnetic pick up tools

Chwytyki magnetyczne..... 188

### Workshop seats

Taborety warsztatowe..... 188

### Workshop creepers

Leżanki warsztatowe..... 189

### Impact wrenches

Klucze udarowe..... 189

### Workshop lamps

Lampy warsztatowe..... 189

### Bottle & floor jacks

Dźwigniki słupkowe i podnośniki..... 191

### Scissors jacks

Podnośniki mechaniczne..... 192

### Jack stands

Podstawki pod samochód..... 192

### Porta power kits

Rozpierzaki hydrauliczne..... 193

### Pull-back rams

Ściągacze blacharskie hydrauliczne..... 193

### Battery chargers

Prostowniki..... 193

### Tire pressure gauges

Mierniki ciśnienia..... 194

### Chain blocks

Wciągarki łańcuchowe..... 194

## Car accessories Akcesoria samochodowe

194-201



### Pumps

Pompki..... 194

### Tow ropes

Linki holownicze..... 195

### Battery clamp cleaners

Szczotki do czyszczenia klem..... 196

### Battery hydrometers

Próbniki akumulatorowe..... 197

### Booster cables

Wiązki przewodów awaryjnych..... 197

### Scrapers & brushes

Skrabaczki i szczotki..... 197

### Flexible funnels

Lejki..... 197

### Car vacuum cleaners

Odkurzacze samochodowe..... 198

### Fire extinguishers

Gaśnice samochodowe..... 198

### First aid kits

Apteczki..... 198

### Safety triangles

Trójkąty ostrzegawcze..... 199

### Ratchet tie downs

Taśmy do bagażu..... 199

### Tarpaulins

Płandeki..... 201

- PL Szafka serwisowa z narzędziami
- GB Service tool cabinet with tools
- D Serviceschrank mit Werkzeugen
- RUS Сервисный шкаф с инструментами
- CZ Servisní skříňka s nářadím
- RO Cutie de service cu scule
- H Szervizszekrény szerszámokkal
- E Armario para herramientas de servicio



177 PCS 12 TRAYS WYŁAD	901x770 x458mm	DRAWERS LOCKING BLOKADA SZUFLAD	CENTRAL LOCK CENTRALNY ZAMEK	2x1 KŁÓC	CORNER BUMPERS NARÓŻNE ODBOJNIKI
6x	WHEEL KÓŁKA	2x BRAKE HAMULCE	BALL BEARING ŁOŻYSKA KULKOWE	NON SLIP WORKTOP BLAT ANTYPOŚLIZGOWY	UNIVERSAL PERFORATION UNIWERSALNA PERFORACJA



12 interchangeable trays with tools  
12 wymiennych modułów z narzędziami



No.	drawers / szuflady	
58540	6	1

- PL Szafka serwisowa
- GB Roller cabinet
- D Werkstattrollwagen
- RUS Инструментальный кабинет
- CZ Dílenská skříňka
- RO Dulap de scule
- H Görgös szerszámátároló
- E Armario en ruedas

6x	901x770 x458mm	DRAWERS LOCKING BLOKADA SZUFLAD	CENTRAL LOCK CENTRALNY ZAMEK	2x1 KŁÓC	CORNER BUMPERS NARÓŻNE ODBOJNIKI
WHEEL KÓŁKA	2x BRAKE HAMULCE	BALL BEARING ŁOŻYSKA KULKOWE	NON SLIP WORKTOP BLAT ANTYPOŚLIZGOWY	UNIVERSAL PERFORATION UNIWERSALNA PERFORACJA	



No.	drawers / szuflady	
58539	6	1

**DRAWER / SZUFLADA 1**  
 1/2" (12.7 mm); 10, 11, 12, 13, 14, 15, 16, 17, 18, 19, 20, 21, 22, 23, 24, 27, 30, 32 mm; CrV 50BV30; 1/2" (12.7 mm); (127 mm); CrV 50BV30; 1/2" (12.7 mm); CrV 50BV30; 1/2" (12.7 mm); (255 mm); T2T; CrV 6140; 1/2" (12.7 mm); (255 mm); CrV 50BV30; 1/2" (12.7 mm); 16; 21 mm; CrV 50BV30

3/8" (9.5 mm); 6, 7, 8, 9, 10, 11, 12, 13, 14, 15, 16, 17, 18, 19, 20, 21, 22 mm; CrV 50BV30; 3/8" (9.5 mm); (76, 152.4 mm); CrV 50BV30; 3/8" (9.5 mm); CrV 50BV30; 3/8" (9.5 mm); (200 mm); T2T; CrV 6140; 3/8" (9.5 mm); (198 mm); CrV 50BV30

1/4" (6.3 mm); 3.5, 4, 4.5, 5, 5.5, 6, 7, 8, 9, 10, 11, 12, 13, 14 mm; CrV 50BV30; 1/4" (6.3 mm); 8, 10, 11, 12, 13 mm; CrV 50BV30; 1/4" (6.3 mm); (50.8, 101.6 mm); CrV 6140; 1/4" (6.3 mm); CrV 50BV30; 1/4" (6.3 mm); (155 mm); T2T; CrV 6140; 1/4" (6.3 mm); (150 mm); CrV 50BV30; 1/4" (6.3 mm); (152.4 mm); CrV 50BV30

**DRAWER / SZUFLADA 2**  
 3x75 mm, 5x100 mm, 5x150 mm, 6x38 mm, 6x100 mm, 6x150 mm, 8x150 mm; CrV;  
 PH0x100 mm, PH1x75 mm, PH1x100 mm, PH2x38 mm, H2x100 mm, PH2x150 mm, PH3x150 mm; CrV;  
 160 mm; 160 mm; 160 mm; 160 mm BENT / WYGIĘTE

**DRAWER / SZUFLADA 3**  
 6x7, 8x9, 10x11, 12x13, 14x15, 16x17, 18x19 mm; 22, 24, 27, 28, 30, 32 mm; 6, 7, 8, 9, 10, 11, 12, 13, 14, 15, 16, 17, 18, 19, 20, 21 mm

**DRAWER / SZUFLADA 4**  
 1/2" (12.7 mm); 8, 9, 10, 11, 12, 13, 14, 15, 16, 17, 18, 19, 20, 21 mm (L=76 mm); CrV 50BV30;

1/2" (12.7 mm); 3/8" (9.5 mm); H4, H5, H6, H7, H8, H10, H12 (L=30 mm); H4, H5, H6, H7, H8, H10, H12 (L=75 mm); CrV; M5, M6, M7, M10, M12 (L=30 mm); M5, M6, M7, M10, M12 (L=75 mm); CrV; T20, T25, T30, T40, T45, T50, T55 (L=30 mm); T20, T25, T30, T40, T45, T50, T55 (L=75 mm); CrV;

300 g (L=300 mm); 40 mm (L=300 mm); 10x8x142 mm, 12x10x152 mm, 16x13x170 mm

14

- PL Szafka serwisowa
- GB Roller cabinet
- D Werkstattrollwagen
- RUS Инструментальный кабинет
- CZ Dílenská skříňka
- RO Dulap de scule
- H Görgös szerszámátároló
- E Armario en ruedas



No.	drawers / szuflady	
81830	6	1

- PL Smarownica
- GB Lever grease gun
- D Handhebelbrettpresse
- RUS Ручной смазочный шприц
- CZ Maznice na šmír
- RO Pistol de gresat-vaselina
- H Sirzó /támlóvel/
- E Engrasador

400ml

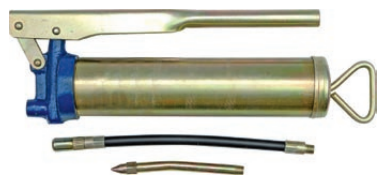

No.	ml	
78040	400	10



- PL Smarownica  
GB Lever grease gun  
D Handhebel Fettpresse  
RUS Ручной смазочный шприц
- CZ Maznice na šmír  
RO Pistol de gresat-vaselina  
H Szíró /tömlővel/  
E Engrasador



No.	cm <sup>3</sup>	
78046	400	10

- PL Smarownica  
GB Lever grease gun  
D Handhebel Fettpresse  
RUS Ручной смазочный шприц
- CZ Maznice na šmír  
RO Pistol de gresat-vaselina  
H Szíró /tömlővel/  
E Engrasador

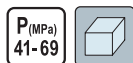

No.	cm <sup>3</sup>	
78042	400	5/10

- PL Towotnica  
GB Lever grease gun  
D Hand-fettpresse  
RUS Ручной смазочный шприц
- CZ Maznice na šmír  
RO Pistol de gresat cu tija rigida  
H Szíró /tömlővel/  
E Engrasador



No.	cm <sup>3</sup>	
78050	445	15

- PL Wężyk do towotnicy  
GB Flexible tube for grease gun  
D Schlauch für Fettpresse  
RUS Шланг для шприца
- CZ Hadička na maznice na šmír  
RO Furtun flexibil pt. pistol de gresat  
H Tömlő a zsíróhoz  
E Manguera para engrasador



No.	L (mm)	
78045	240	50/250

- PL Smarownica  
GB Lever grease gun  
D Handhebel Fettpresse  
RUS Ручной смазочный шприц
- CZ Maznice na šmír  
RO Pistol de gresat-vaselina  
H Szíró /tömlővel/  
E Engrasador



No.	cm <sup>3</sup>	
78041	400	5/10

- PL Towotnica  
GB Lever grease gun  
D Handhebel Fettpresse  
RUS Ручной смазочный шприц
- CZ Maznice na šmír  
RO Pistol de gresat-vaselina  
H Szíró /tömlővel/  
E Engrasador



No.	cm <sup>3</sup>	
78047	500	10

- PL Smarownica  
GB Lever grease gun  
D Handhebel Fettpresse  
RUS Ручной смазочный шприц
- CZ Maznice na šmír  
RO Pistol de gresat-vaselina  
H Szíró /tömlővel/  
E Engrasador



No.	cm <sup>3</sup>	
78043	600	6/12

- PL Zestaw korcówek czterozczękowych do smarownic  
GB Heavy duty jaw couplers  
D Mundstücksatz für Handhebel Fettpressen  
RUS Соединительные патроны для масляного пистолета
- CZ Sada koncovek k mazacímu lisu  
RO Doza de legatura  
H Tömlő csatlakozó karos zsíróhoz  
E Juego de boquillas para engrasadores

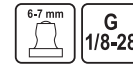

No.	Ø (mm)	pcs	
78061	15	4	20/80

- PL Wężyk giętki do smarownic  
 GB Flexible hose for grease gun  
 D Schlauch für Fettpresse  
 RUS Гибкий шланг для тоivotницы  
 CZ Hadička na maznice na šmir  
 RO Furtun flexibil pt. pistol de gresat  
 H Tömlő a zsírzóhoz  
 E Manguera para engrasador



No.	L (mm)	Mpa	
78067	300	31	50/250
78068	500	31	50/250

- PL Odsysarka ręczna do oleju  
 GB Oil drainer  
 D Öl-Absaugpumpe  
 RUS Ручной шприц для откачки масла
- CZ Ruční odsávačka oleje  
 RO Pompa de ulei  
 H Kézi olajszivattyú  
 E Bomba de succión manual para aceite



No.	cm³	
78030	200	10

- PL Odsysarka ręczna do oleju  
 GB Oil drainer  
 D Öl-Absaugpumpe  
 RUS Ручной шприц для откачки масла
- CZ Ruční odsávačka oleje  
 RO Pompa de ulei  
 H Kézi olajszivattyú  
 E Bomba de succión manual para aceite

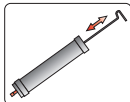

No.	cm³	
78044	500	10/20

- PL Oliwiarka  
 GB Oil can  
 D Ölkanne  
 RUS Масленка
- CZ Maznička  
 RO Pompiță de ulei  
 H Olajozó  
 E Aceitera



No.	ml	
78300	300	15/60

- PL Pompa ręczna do oleju  
 GB Manual oil pump  
 D Öl-Umfüllpumpe  
 RUS Ручной насос для перекачки масел

- CZ Pumpa ruční na olej  
 RO Pompa manuala apa ulei  
 H Kézi olajszivattyú  
 E Bomba manual para aceite



No.	l / min	
78000	19	5

- PL Odsysarka ręczna do oleju  
 GB Oil drainer  
 D Öl-Absaugpumpe  
 RUS Ручной шприц для откачки масла
- CZ Ruční odsávačka oleje  
 RO Pompa de ulei  
 H Kézi olajszivattyú  
 E Bomba de succión manual para aceite



No.	cm³	
78031	400	10

- PL Pompa ręczna do oleju  
 GB Manual oil pump  
 D Öl-Umfüllpumpe  
 RUS Ручной насос для перекачки масел
- CZ Pumpa ruční na olej  
 RO Pompa manuala apa ulei  
 H Kézi olajszivattyú  
 E Bomba manual para aceite



No.	cm³	
78035	500	10

- PL Oliwiarka z wężkiem  
 GB Oil can with flexible hose  
 D Ölkanne mit flexiblem Aufsatz  
 RUS Масленка с гибким шлангом
- CZ Olejova maznice  
 RO Cana ulei cu furtun flexibil  
 H Olajozó kanna, hajlékony tömlővel  
 E Aceitera



No.	ml	
78306	200	10/60

- PL** Oliwiarka z kołcówką sztywną  
**GB** Oil can with rigid spout  
**D** Ölkanne mit starrem Aufsatz  
**RUS** Масленка с твердым наконечником

- CZ** Olejová mазnice  
**RO** Cana ulei cu furcun rigid  
**H** Olajozó kanna, merev szárral  
**E** Aceitera

**VOREL**

No.	ml	Icon
78303	300	10/60

- PL** Klucz do filtra oleju, zaciskowy  
**GB** Oil filter wrench  
**D** Ölfilterschlüssel  
**RUS** Съёмник масляных фильтров зажимной

- CZ** Klíč na filtr oleju svěrácí  
**RO** Cheie cu strângere pt. filtru de ulei  
**H** Olajszűrő kulcs, patintós  
**E** Llave de filtro de apriete

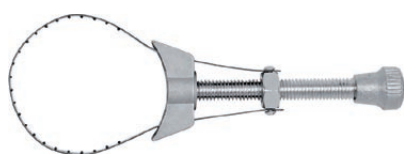
**VOREL**

No.	Ø (mm)	Icon
57610	55-110	10/50

- PL** Klucz do filtra oleju  
**GB** Oil filter wrench  
**D** Ölfilterspinne  
**RUS** Съёмник масляных фильтров

- CZ** Klíč na filtr oleju  
**RO** Cheie pt. filtru de ulei  
**H** Olajszűrő kulcs  
**E** Llave de filtro



No.	Icon
57630	10/40

- PL** Klucz do filtra oleju  
**GB** Oil filter wrench  
**D** Ölfilterschlüssel  
**RUS** Ключ к масляному фильтру

- CZ** Klíč na filtr oleju  
**RO** Cheie pt. filtru de ulei  
**H** Olajszűrő kulcs  
**E** Llave para el filtro de aceite

**VOREL**

No.	Ø (mm)	Icon
57649	55-75	10/50
57650	75-95	10/50
57651	95-115	10/50

- PL** Klucz do filtra oleju  
**GB** Oil filter wrench  
**D** Ölfilterspinne  
**RUS** Съёмник масляных фильтров

- CZ** Klíč na filtr oleju  
**RO** Cheie pt. filtru de ulei  
**H** Olajszűrő kulcs  
**E** Llave de filtro

**VOREL**

No.	size / rozmiar	Ø (mm)	Icon
57600	3/8" (10.0 mm)	65-110	6/36

- PL** Klucz do filtra oleju  
**GB** Oil filter wrench  
**D** Ölfilterspinne  
**RUS** Съёмник масляных фильтров

- CZ** Klíč na filtr oleju  
**RO** Cheie pt. filtru de ulei  
**H** Olajszűrő kulcs  
**E** Llave de filtro



No.	Icon
57620	10/100

- PL** Klucz do filtra oleju  
**GB** Oil filter wrench  
**D** Ölfilterspinne  
**RUS** Съёмник масляных фильтров

- CZ** Klíč na filtr oleju  
**RO** Cheie pt. filtru de ulei  
**H** Olajszűrő kulcs  
**E** Llave de filtro

**VOREL**

No.	Icon
57640	25/100



PL Klucz do filtra oleju  
GB Oil filter wrench  
D Ölfilterschlüssel  
RUS Ключ к масляному фильтру

CZ Klíč na filtr oleju  
RO Cheie pt. filtru de ulei  
H Olajszűrő kulcs  
E Llave para el filtro de aceite



**VOREL**

No.	Ø (mm)	
57612	73-85	12/48
57613	83-95	12/48
57614	93-111	12/48

PL Ściągacz do łożysk  
GB Gear puller  
D Dreiarmliger abzieher  
RUS Съёмник подшипников 3-х лапчатый

CZ Stahovák na ložiska  
RO Clește cu 3 brațe pt. extras rulmenți  
H Hidraulikus csapágyelhúzó  
E Extractor de cojinetes



No.	mm	arms / ramiona	
80534	0-120	3	2/6

PL Ściągacz do sprężyn  
GB Coil spring clamp  
D Federspanner  
RUS Стяжка пружин

CZ Stahovák na pružiny  
RO Dispozitiv pt. demontat arcuri auto  
H Rugóelhúzó  
E Extractor de muelles



No.	pcs. packing	
80601	2	10

PL Ściągacz do sworzni kulistych  
GB Tie rod end lifter  
D Universal-kugelgelenk-abzieher  
RUS Съёмник шаровых опор

CZ Stahovák kulových čepů řízení  
RO Extractor pt. articulatii sferice  
H Gömbfej kinyomó  
E Extractor pt. articulatii sferice

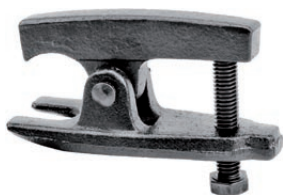

**VOREL**

No.		
80640		25

PL Ściągacz do łożysk  
GB Gear puller  
D Dreiarmliger abzieher  
RUS Съёмник подшипников 3-х лапчатый  
CZ Stahovák na ložiska  
RO Clește cu 3 brațe pt. extras rulmenți  
H Hidraulikus csapágyelhúzó  
E Extractor de cojinetes



No.	mm	arms / ramiona	
80500	75	3	4/40
80510	100	3	5/30
80520	150	3	2/20
80530	200	3	2/12

PL Ściągacz do sprężyn  
GB Coil spring clamp  
D Federspanner  
RUS Стяжка пружин

CZ Stahovák na pružiny  
RO Dispozitiv pt. demontat arcuri auto  
H Rugóelhúzó  
E Extractor de muelles



**VOREL**

No.	pcs. packing	
80600	2	6/12

PL Ściągacz do sworzni kulistych  
GB Tie rod end lifter  
D Universal-kugelgelenk-abzieher  
RUS Съёмник шаровых опор

CZ Stahovák kulových čepů řízení  
RO Extractor pt. articulatii sferice  
H Gömbfej kinyomó  
E Extractor pt. articulatii sferice



**VOREL**

No.		
80620		25/50

PL Krzyżakowy klucz do kół  
GB Cross rim wrench  
D Kreuzschlüssel  
RUS Балонный ключ-крест

CZ Klíč na kola křížový  
RO Cheie în cruce pt. roți  
H Kereszt kerékkulcs  
E Llave cruz para ruedas



**VOREL**

No.	mm / inch (cale)	
57000	17x19x22x13/16" (20.6 mm)	20

- PL Krzyżakowy klucz do kół  
GB Cross rim wrench  
D Kreuzschlüssel  
RUS Балонный ключ-крест
- CZ Klíč na kola křížový  
RO Cheie în cruce pt. roți  
H Kereszt kerékkulcs  
E Llave cruz para ruedas



No.	mm	
57010	17x19x21x23	20

- PL Krzyżakowy klucz do kół  
GB Cross rim wrench  
D Kreuzschlüssel  
RUS Балонный ключ-крест
- CZ Klíč na kola křížový  
RO Cheie în cruce pt. roți  
H Kereszt kerékkulcs  
E Llave cruz para ruedas



No.	mm	
57030	17x19x21x23	20

- PL Klucz do kół rozsuwany  
GB L-type wheel wrench  
D Radschlüssel  
RUS Ключ баллонный телескопический L-типа
- CZ Klíč na kola rozvírání  
RO Cheie pt. roți extensibilă  
H Kerékkulcs, kihúzható  
E Llave para ruedas extensible

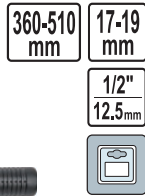

No.	mm	L (mm)	size / rozmiar	
57100	17/19	360-510	1/2" (12.5 mm)	10/20

- PL Klucz do świec  
GB Spark plug wrench  
D Zündkerzenschlüssel  
RUS Ключ свечной
- CZ Svičkový klíč  
RO Cheie pt. bujii  
H Gyertyakulcs  
E Llave para bujias



No.	mm	L (mm)	
57160	16	150	25/50
57210	21	150	25/50

- PL Krzyżakowy klucz do kół  
GB Cross rim wrench  
D Kreuzschlüssel  
RUS Балонный ключ-крест
- CZ Klíč na kola křížový  
RO Cheie în cruce pt. roți  
H Kereszt kerékkulcs  
E Llave cruz para ruedas



No.	mm / inch (cale)	
57020	17x19x21x1/2" (12.7 mm)	10

- PL Krzyżakowy klucz do kół  
GB Cross rim wrench  
D Kreuzschlüssel  
RUS Балонный ключ-крест
- CZ Klíč na kola křížový  
RO Cheie în cruce pt. roți  
H Kereszt kerékkulcs  
E Llave cruz para ruedas



No.	mm / inch (cale)	
57050	24x27x32x3/4" (19.0 mm)	5

- PL Zaciskacz do pierścieni  
GB Piston ring compressor  
D Kolbenring-Spannband  
RUS Зажим колец  
CZ Svěrka na kroužky  
RO Cleșta pt. strâns inele  
H Gyűrűbepattintó  
E Pinza para anillos



No.	Ø (mm)	H (mm)	
80660	50-125	75	36
80661	75-175	100	36

- PL Klucz do świec  
GB Spark plug wrench  
D Zündkerzenschlüssel  
RUS Ключ свечной
- CZ Svičkový klíč  
RO Cheie pt. bujii  
H Gyertyakulcs  
E Llave para bujias



No.	mm	L (mm)	
57260	16/21	150	25/50

- PL Klucze do przewodów hamulcowych  
 GB Flare nut wrenches  
 D Bremsleitungschlüsselsatz  
 RUS Набор ключей разрезных
- CZ Kľiče na vedení brzd  
 RO Cheie pt. conducte de frână  
 H Fékcsőkulcs  
 E Llaves para tubería de frenado

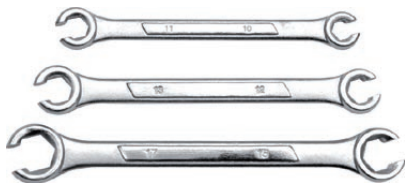

No.	pcs	Box
57700	3	12/60

- PL Samochodowy próbnik napięcia  
 GB Car voltage tester  
 D Autospannungstester  
 RUS Пробник автомобильный
- CZ Automobilový zkoušeč napětí  
 RO Creion de tensiune pt. automobile  
 H Autós fáziskereső  
 E Comprobador de corriente de coche



No.	V	Box
65270	6-24	20/200

- PL Łapka magnetyczna, giętka  
 GB Flexible pick-up handle, magnetic  
 D Magnetisch flexibel greifer  
 RUS Гибкий магнитный захват
- CZ Vytahováč magnetický ohebný  
 RO Surubelnita flexibilă magnetică  
 H Mágneses felszedő eszköz, hajlékony nyél  
 E Grifo magnético flexible



No.	L (mm)	Box
78401	530	50/100

- PL Chwytek teleskopowy LED  
 GB LED magnetic pick up tool  
 D LED magnet heber  
 RUS Захват магнитный телескопический с подсветкой  
 CZ Patka magnetická teleskopická LED  
 RO Telescop magnetic cu LED  
 H LED felszedő mágnes teleszkópos nyéllel  
 E Herramienta para levantar, telescópica, con LED

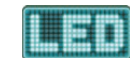

No.	LED	battery / bateria	Box
78405	3	4xLR44	12/48

- PL Samochodowy próbnik napięcia  
 GB Car voltage tester  
 D Autospannungstester  
 RUS Пробник автомобильный
- CZ Automobilový zkoušeč napětí  
 RO Creion de tensiune pt. automobile  
 H Autós fáziskereső  
 E Comprobador de corriente de coche



No.	V	Box
65260	6-24	20/200

- PL Łapka do podnoszenia  
 GB Pick-up tool  
 D Starer Greifer  
 RUS Гибкий захват „Pick-up”
- CZ Patka pro zdvihání  
 RO Surubelnita flexibilă  
 H Emelőlapka  
 E Grifo para recoger pick up



No.	L (mm)	Box
78400	600	50/150

- PL Łapka magnetyczna, teleskopowa  
 GB Pick-up handle, magnetic  
 D Magnetisch greifer  
 RUS Магнитный захват
- CZ Vytahováč magnetický teleskopický  
 RO Surubelnita telescopica cu magnet  
 H Mágneses felszedő eszköz, teleszkópos nyél  
 E Grifo magnético



No.	L (mm)	Box
78402	630	25/100

- PL Taboret warsztatowy  
 GB Workshop seat  
 D Taboret warsztatowy  
 RUS Табурет рабочий
- CZ Dílný taburet  
 RO Taburet atelier  
 H Műhely zsámoly  
 E Taburete de taller



No.	max (kg)	Box
81823	90	4

PL Taboret warsztatowy z szufladą  
GB Workshop seat with drawer  
D Werkstattthocker mit Schublade  
RUS Табурет рабочий с ящиком

CZ Dílenský taburet se zásuvkou  
RO Taburet atelier cu sertar  
H Műhely zsámoly fiókkal  
E Taburete de taller con cajón



**VOREL**

No.	max (kg)	
81824	90	4

PL Leżanka warsztatowa na kółkach  
GB Workshop creeper  
D Werkstattliegewagen auf Rädern  
RUS Лежак ремонтный

CZ Lehátko montážní na kolečkách  
RO Targa auto mobilă  
H Fekpad gurulós  
E Camilla de taller con ruedas



**VOREL**

No.	mm	
81820	930x440x105	1

PL Diodowa lampa bezprzewodowa  
GB Rechargeable work lamp  
D Led Werkstattlampe  
RUS Светодиодная беспроводная лампа  
CZ Montážní lampa diodová bezpřívodová  
RO Lampa cu led fara cablu  
H Ledlámpa  
E Lámpara inalámbrica de diodos

**SMD**



12 LED	200 lm	CHARGING TIME CZAS ŁADOWANIA 4 h	WORK TIME CZAS PRACY 4,5 h
12V 2000mAh Li-Ion	230V~50Hz BATTERY CHARGER ŁADOWNIK	12V BATTERY CHARGER ŁADOWNIK	HOOK HAK



**VOREL**

No.	LED	mAh	
82728	12	2000	20

PL Diodowa lampa bezprzewodowa  
GB Rechargeable work lamp  
D Led Werkstattlampe  
RUS Светодиодная беспроводная лампа

CZ Montážní lampa diodová bezpřívodová  
RO Lampa cu led fara cablu  
H Ledlámpa  
E Lámpara inalámbrica de diodos



**VOREL**

No.	LED	mAh	
82720	36	500	10/20

PL Taboret warsztatowy teleskopowy  
GB Pneumatic car seat  
D Werkstattthocker, teleskopisch  
RUS Табурет рабочий подъемный

CZ Dílenský taburet teleskopický  
RO Taburet atelier telescopic  
H Teleszkópos műhely zsámoly  
E Taburete de taller telescópico



**VOREL**

No.	max (kg)	
81825	135	4

PL Elektryczny klucz udarowy  
GB Electric impact wrench  
D Elektro-Schlagschrauber  
RUS Электрический гайковёрт  
CZ Elektrický rázový utahovák  
RO Cheie electrică  
H Elektromos ütvecsavarozó  
E llave de impacto eléctrica

230V~50Hz	800 W	2200 min <sup>1</sup>	325 Nm
1/2" 12.5 mm	17, 19 21, 22 mm		



L<sub>pa</sub> = 87,5 ± 3,0 dB;  
L<sub>wa</sub> = 98,5 ± 3,0 dB;  
a<sub>v</sub> = 9,93 ± 1,5 m/s<sup>2</sup>

**STHOR**

No.	W	min-1	
57091	800	2200	5

PL Diodowa lampa bezprzewodowa  
GB Rechargeable work lamp  
D Led Werkstattlampe  
RUS Светодиодная беспроводная лампа  
CZ Montážní lampa diodová bezpřívodová  
RO Lampa cu led fara cablu  
H Ledlámpa  
E Lámpara inalámbrica de diodos

3W	200 lm	3.7V 2000mAh Li-Ion	12V BATTERY CHARGER ŁADOWNIK	FRONT LIGHTING FUNCIJA LAMPARA
230V~50Hz BATTERY CHARGER ŁADOWNIK	MAGNETIC	WORK TIME CZAS PRACY 4 h	CHARGING TIME CZAS ŁADOWANIA 4 h	HOOK HAK



**COB**  
**LED**

**VOREL**

No.	W	mAh	
82719	3	2000	20

PL Lampa robocza LED  
GB LED work light  
D LED Werkstattlampe  
RUS Светодиодный светильник для мастерской  
CZ Ruční svítidla LED  
RO Lampa portabila cu LED  
H LED lámpa  
E Lámpara de taller LED

230V~50Hz	280 lm	16 LED
HOOK HAK	4,5 W	5,0m

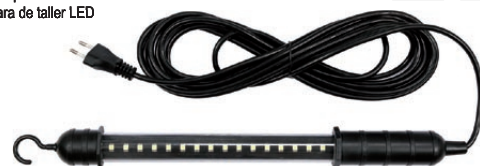

**VOREL**

No.	W	LED	
82699	4.5	16	10/20

- PL Lampa robocza LED
- GB LED work light
- D LED Werkstattlampe
- RUS Светодиодный светильник для мастерской
- CZ Ruční svítilna LED
- RO Lampa portabila cu LED
- H LED lámpa
- E Lámpara de taller LED

230V~  
50Hz

400  
lm

24  
LED

HOOK  
HAK

4.5  
W

5.0m



SMD  
LED

VOREL

No.	W	LED	☐
82706	4.5	24	10/20

- PL Lampa warsztatowa
- GB Work light
- D Werkstattlampe
- RUS Лампа-переноска
- CZ Pracovní lampa
- RO Lampă pt. atelier
- H Szerelőlámpa
- E Lámpara de taller

230V~  
50Hz



E 27

100  
W

5.0m



No.	W	type	☐
82713	100	„PRACTIC“	10

- PL Lampa warsztatowa
- GB Work light
- D Werkstattlampe
- RUS Лампа-переноска
- CZ Pracovní lampa
- RO Lampă pt. atelier
- H Szerelőlámpa
- E Lámpara de taller

230V~  
50Hz



E 27

60W

5.0m



No.	W	type	☐
82712	60	„BASKET“	10

- PL Lampa warsztatowa
- GB Work light
- D Werkstattlampe
- RUS Лампа-переноска
- CZ Pracovní lampa
- RO Lampă pt. atelier
- H Szerelőlámpa
- E Lámpara de taller

230V~  
50Hz



E 27

5.0m



No.	W	type	☐
82716	60	„GUMMI“	10
82717	100	„GUMMI“	10

- PL Lampa warsztatowa
- GB Work light
- D Werkstattlampe
- RUS Лампа-переноска
- CZ Pracovní lampa
- RO Lampă pt. atelier
- H Szerelőlámpa
- E Lámpara de taller

230V~  
50Hz



TC-S  
G23

11W

5.0m



No.	W	type	☐
82705	11	„EFFECT“	10

- PL Lampa warsztatowa
- GB Work light
- D Werkstattlampe
- RUS Лампа-переноска
- CZ Pracovní lampa
- RO Lampă pt. atelier
- H Szerelőlámpa
- E Lámpara de taller

230V~  
50Hz



E 27

60W

5.0m



No.	W	type	☐
82715	60	„PLASTIC“	10

- PL Lampa warsztatowa
- GB Work light
- D Werkstattlampe
- RUS Лампа-переноска
- CZ Pracovní lampa
- RO Lampă pt. atelier
- H Szerelőlámpa
- E Lámpara de taller

230V~  
50Hz



E 27

60W

5.0m



No.	W	type	☐
82714	60	„CLASSIC“	10

- PL Lampa robocza LED
- GB LED work light
- D LED Handleuchte
- RUS Светодиодный светильник для мастерской
- CZ Ruční svítilna LED
- RO Lampa portabila cu LED
- H LED lámpa
- E Lámpara de taller LED

MAGNETIC

HOOK  
HAK

3x1.5V  
(AAA)  
NOT INCLUDED  
NÉ ZALAZÁSZ



COB  
LED

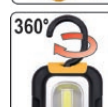

VOREL

No.	battery / bateria	☐
82724	3xAAA	12/48



- PL Lampa robocza LED
- GB LED work light
- D LED Handleuchte
- RUS Светодиодный светильник для мастерской
- CZ Ruční svítidla LED
- RO Lampa portabila cu LED
- H LED lámpa
- E Lámpara de taller LED



**SMD LED**



No.	LED	battery / bateria	
82730	20+3	3xAAA	12/48

- PL Lampa robocza LED
- GB LED work light
- D LED Handleuchte
- RUS Светодиодный светильник для мастерской
- CZ Ruční svítidla LED
- RO Lampa portabila cu LED
- H LED lámpa
- E Lámpara de taller LED



**COB LED**



No.	battery / bateria	
82726	3xAAA	12/144

- PL Lampa robocza LED
- GB LED work light
- D LED Handleuchte
- RUS Светодиодный светильник для мастерской

- CZ Ruční svítidla LED
- RO Lampa portabila cu LED
- H LED lámpa
- E Lámpara de taller LED



**SMD LED**



No.	LED	battery / bateria	
82742	6+1	3xAAA	12/48

- PL Podnośnik hydrauliczny słupkowy
- GB Hydraulic bottle jack
- D Hydraulischen Wagenheber
- RUS Домкрат гидравлический „Бутылочный”

- CZ Pístový zvedák hydraulický
- RO Cric hidraulic cu piston
- H Hidraulikus emelő
- E Gato de embolo hidr.



No.	max t	↑ mm	
80012	2	148-276	6
80022	3	180-350	6
80032	5	185-355	4
80042	8	190-365	4
80052	10	195-375	4
80062	12	200-380	3
80072	15	205-390	2
80082	20	217-402	2

- PL Lampa robocza LED
- GB LED work light
- D LED Handleuchte
- RUS Светодиодный светильник для мастерской
- CZ Ruční svítidla LED
- RO Lampa portabila cu LED
- H LED lámpa
- E Lámpara de taller LED



**SMD LED**



No.	LED	battery / bateria	
82731	24+3	3xAAA	12/48

- PL Lampa robocza LED
- GB LED work light
- D LED Handleuchte
- RUS Светодиодный светильник для мастерской
- CZ Ruční svítidla LED
- RO Lampa portabila cu LED
- H LED lámpa
- E Lámpara de taller LED



No.	LED	battery / bateria	
82735	36+1	4xAAA	12/48

- PL Latarka LED
- GB LED Flashlight
- D LED-Taschenlampe
- RUS Светодиодный фонарь

- CZ LED svítidla
- RO Lanterna cu LED
- H LED elemilámpa
- E Linterna LED



No.	W	lumens	battery / bateria	
88550	3	150	3xAAA	12/48

**POWER LED**



PL Dźwignik tłokowy hydrauliczny  
GB Hydraulic floor jack  
D Hydraulischer Rangierwagenheber  
RUS Домкрат гидравлический подкатной

CZ Pístový zvedák hydraulický – pracovní  
RO Cric hidraulic cu piston pt. atelier  
H Hidraulikus emelő – szervíz  
E Gato de embolo hidr.rana

2t



VOREL

No.	max t	↑ mm	
80111	2	135-325	1

PL Dźwignik tłokowy hydrauliczny  
GB Hydraulic floor jack  
D Hydraulischer Rangierwagenheber  
RUS Домкрат гидравлический подкатной

CZ Pístový zvedák hydraulický – pracovní  
RO Cric hidraulic cu piston pt. atelier  
H Hidraulikus emelő – szervíz  
E Gato de embolo hidr.rana

2t



VOREL

No.	max t	↑ mm	
80120	2	130-360	1

PL Dźwignik tłokowy hydrauliczny  
GB Hydraulic floor jack  
D Hydraulischer Rangierwagenheber  
RUS Домкрат гидравлический подкатной

CZ Pístový zvedák hydraulický – pracovní  
RO Cric hidraulic cu piston pt. atelier  
H Hidraulikus emelő – szervíz  
E Gato de embolo hidr.rana

3t



VOREL

No.	max t	↑ mm	
80233	3	150-485	1

PL Podnośnik mechaniczny trapezowy  
GB Scissors jack  
D Trapezwagenheber  
RUS Домкрат механический ромбовый

CZ Lichoběžníkový zvedák  
RO Cric mecanic  
H Trapézemelő  
E Gato mecanico-trapezoidal



No.	t	↑ mm	
80271	1.2	100-350	4

PL Dźwignik tłokowy hydrauliczny  
GB Hydraulic floor jack  
D Hydraulischer Rangierwagenheber  
RUS Домкрат гидравлический подкатной

CZ Pístový zvedák hydraulický – pracovní  
RO Cric hidraulic cu piston pt. atelier  
H Hidraulikus emelő – szervíz  
E Gato de embolo hidr.rana

2t



VOREL

No.	max t	↑ mm	
80121	2	130-350	1

PL Dźwignik tłokowy hydrauliczny  
GB Hydraulic floor jack  
D Hydraulischer Rangierwagenheber  
RUS Домкрат гидравлический подкатной

CZ Pístový zvedák hydraulický – pracovní  
RO Cric hidraulic cu piston pt. atelier  
H Hidraulikus emelő – szervíz  
E Gato de embolo hidr.rana

2.25t



VOREL

No.	max t	↑ mm	
80220	2.25	140-520	1

PL Podnośnik mechaniczny trapezowy  
GB Scissors jack  
D Trapezwagenheber  
RUS Домкрат механический ромбовый

CZ Lichoběžníkový zvedák  
RO Cric mecanic  
H Trapézemelő  
E Gato mecanico-trapezoidal



VOREL

No.	t	↑ mm	
80252	1.5	95-390	5

PL Podstawka pod samochód  
GB Jack stand  
D Unterstellbock  
RUS Подставка для автомобиля  
CZ Podstavec pod auto  
RO Chituc de metal  
H Gépkocsi alátét  
E Apoyos de coche

2t



No.	t	L (mm)	
80300	2	380	5

- PL Podstawka pod samochód  
GB Jack stand  
D Unterstellbock  
RUS Подставка для автомобиля  
CZ Podstavec pod auto  
RO Chituc de metal  
H Gépkocsi alátét  
E Apoyos de coche



No.	t	↑ mm	pcs / packing	☐
80307	2	265-415	2	1
80308	3	280-420	2	1
80309	6	382-600	2	1

- PL Rozpierzak hydrauliczny  
GB Porta power repair kit  
D Hydraulischer richt und ausbeulsatz  
RUS Гидравлическая распорная стойка в наборе
- CZ Hydraulický rozpěrák  
RO Trusa pompa hidraulica + accesorii  
H Hidraulikus bontó  
E Cilindro de freno

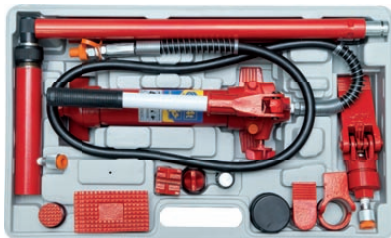

No.	t	☐
80402	4	1

- PL Pompa do rozpietaka hydraulicznego  
GB Accessories for porta power  
D Druckeinheit für Hydr. Spreizer  
RUS Ручной насос для гидравлической распорной стойки
- CZ Pumpa na hydraulický rozpěrák  
RO Pompa hidraulica  
H Szivattyú hidraulikus bontóhoz  
E Bomba para cilindro de freno



No.	t	☐
80320	4	2
80330	10	2

- PL Siłownik do rozpietaka hydraulicznego  
GB Accessories for porta power  
D Kraftzylinder für Hydr. Spreizer  
RUS Сервомотор для гидравлической распорной стойки
- CZ Servomotor na hydraulický rozpěrák  
RO Accesorii pompa hidraulica  
H Erőátvitel a hidraulikus bontóhoz  
E Servo para cilindro de freno



No.	t	☐
80340	4	4
80350	10	4

- PL Podstawka pod samochód  
GB Jack stands  
D Unterstellbock  
RUS Подставка для автомобиля  
CZ Podstavec pod auto  
RO Chituc de metal  
H Gépkocsi alátét  
E Apoyos de coche



No.	t	↑ mm	pcs / packing	☐
80312	2	280-370	2	5

- PL Rozpierzak hydrauliczny  
GB Porta power repair kit  
D Hydraulischer richt und ausbeulsatz  
RUS Гидравлическая распорная стойка в наборе
- CZ Hydraulický rozpěrák  
RO Trusa pompa hidraulica + accesorii  
H Hidraulikus bontó  
E Cilindro de freno

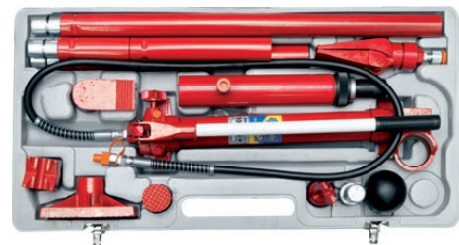

No.	t	☐
80412	10	1

- PL Ściągacz blacharski hydrauliczny  
GB Pull - back ram  
D Hydraulische Zugzylindereinheit  
RUS Гидравлическая стяжка-крюк
- CZ Klempišské stahovadlo hydraulické  
RO Carlig hidraulic tractare  
H Hidraulikus lemezkihúzó  
E Extractor de latoneria de fontanero

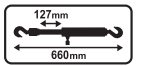

No.	t	MPa	☐
80450	10	55	4

- PL Prostownik  
GB Rectifier  
D Batterieladegerät  
RUS Зарядное устройство
- CZ Usměňovač  
RO Redresor  
H Akkumulátortöltő  
E Rectificador



No.	V	A	Ah	☐
82550	12	2.8	8-56	10
82551	12	4.2	12-84	10

- PL Prostownik
- GB Rectifier
- D Batterieladegerät
- RUS Зарядное устройство
- CZ Usměňovač
- RO Redresor
- H Akkumulátortöltő
- E Rectificador



No.	V	A	Ah	
82552	6 / 12	5.8	12-116	5
82553	6 / 12	10.3	26-206	5

- PL Ciśnieniomierz samochodowy
- GB Tire pressure gauge
- D Reifendruckprüfer
- RUS Шинный манометр

- CZ Automobilový tlakoměr
- RO Manometru
- H Gépkocsi nyomásmérő
- E Manómetro de coche

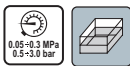

No.	MPa	bar	
82611	0.05-0.3	0.5-3.0	10

- PL Wyciągarka łańcuchowa
- GB Chain block
- D Kettenzug flaschenzug
- RUS Таль цепная
- CZ Zvedák řetězový
- RO Scripete cu lant
- H Láncos csigasor emelő
- E Cabria de cadena



No.	kg	chain / łańcuch (m)	
80751	1000	3	1
80752	2000	3	1
80753	3000	3	1

- PL Pompka tłokowa nożna
- GB Foot pump
- D Fussluftpumpe mit manometer
- RUS Насос ножной с манометром

- CZ Nožní pumpa z manometrem
- RO Pompa de picior
- H Lábpumpa nyomásmérővel
- E Bomba de pierna con manometro



No.	MPa	
82005	0.7	5

- PL Ciśnieniomierz samochodowy
- GB Tire pressure gauge
- D Reifendruckprüfer
- RUS Шинный манометр

- CZ Automobilový tlakoměr
- RO Manometru
- H Gépkocsi nyomásmérő
- E Manómetro de coche

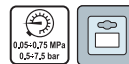

No.	MPa	bar	
82610	0.05-0.75	0.5-7.5	25/150

- PL Ciśnieniomierz do aut ciężarowych
- GB Dual foot tire gauge
- D Reifendruckprüfer
- RUS Шинный манометр для грузовых машин

- CZ Tlakoměr na nákladní auta
- RO Indicator de presiune pt. camioane
- H Nyomásmérő tehergépkocsikhoz
- E Manómetro de caomones



No.	MPa	bar	
82650	0.05-0.75	0.5-7.5	10/100

- PL Pompka nożna z manometrem
- GB Foot pump with manometer
- D Fussluftpumpe mit manometer
- RUS Насос ножной с манометром

- CZ Nožní pumpa z manometrem
- RO Pompă de picior cu manometru
- H Lábpumpa nyomásmérővel
- E Bomba de pierna con manometro



No.	
82000	20

- PL Pompka tłokowa nożna
- GB Foot pump
- D Fussluftpumpe mit manometer
- RUS Насос ножной с манометром

- CZ Nožní pumpa z manometrem
- RO Pompa de picior
- H Lábpumpa nyomásmérővel
- E Bomba de pierna con manometro



No.	MPa	
82001	0-0.7	12

- PL** Pompka tłokowa nożna  
**GB** Foot pump  
**D** Fussluftpumpe mit Manometer  
**RUS** Насос ножной с манометром  
**CZ** Nožni pumpa z manometrem  
**RO** Pompa de picior  
**H** Lábpumpa nyomásmérővel  
**E** Bomba de pierna con manometro

**VOREL**

No.	MPa	Box
82015	0-0.7	6

- PL** Pompka słupkowa z manometrem  
**GB** Hand pump with manometer  
**D** Hand-Luftpumpe mit Manometer  
**RUS** Насос ручной с манометром  
**CZ** Pumpa z manometrem  
**RO** Pompa de mana cu manometru  
**H** Kézi pumpa manométerrel  
**E** Bomba de barrote con manometro

**VOREL**

No.	MPa	Box
82021	1	10

- PL** Linka holownicza  
**GB** Tow rope  
**D** Abschleppseil  
**RUS** Трос автомобильный буксировочный  
**CZ** Těžný provázek  
**RO** Șufă pt. remorcare  
**H** Vonatókötél  
**E** Cable de remolque

**VOREL**

No.	kg	Box
82201	1450	20

- PL** Linka holownicza  
**GB** Tow rope  
**D** Abschleppseil  
**RUS** Трос автомобильный буксировочный  
**CZ** Těžný provázek  
**RO** Șufă pt. remorcare  
**H** Vonatókötél  
**E** Cable de remolque

**VOREL**

No.	kg	Box
82209	2500	8

- PL** Pompka słupkowa ręczna  
**GB** Hand pump  
**D** Hand-Luftpumpe  
**RUS** Насос ручной  
**CZ** Hustlika ruční  
**RO** Pompa de mana cu manometru  
**H** Kézi pumpa  
**E** Bomba de barrote de mano



No.	MPa	Box
82020	0.3	20

- PL** Pompka słupkowa z manometrem  
**GB** Hand pump with manometer  
**D** Hand-Luftpumpe mit Manometer  
**RUS** Насос ручной с манометром  
**CZ** Pumpa z manometrem  
**RO** Pompa de mana cu manometru  
**H** Kézi pumpa manométerrel  
**E** Bomba de barrote con manometro

**VOREL**

No.	MPa	Box
82022	0.1-1	10

- PL** Linka holownicza  
**GB** Tow rope  
**D** Abschleppseil  
**RUS** Трос автомобильный буксировочный  
**CZ** Těžný provázek  
**RO** Șufă pt. remorcare  
**H** Vonatókötél  
**E** Cable de remolque

**VOREL**

No.	kg	Box
82205	2500	10

- PL** Linka holownicza  
**GB** Tow rope  
**D** Abschleppseil  
**RUS** Трос автомобильный буксировочный  
**CZ** Těžný provázek  
**RO** Șufă pt. remorcare  
**H** Vonatókötél  
**E** Cable de remolque

**VOREL**

No.	kg	Box
82200	3500	12

PL Linka holownicza  
GB Tow rope  
D Abschleppseil  
RUS Трос автомобильный буксировочный

CZ Těžný provázek  
RO Șufă pt. remorcare  
H Vonatőkötél  
E Cable de remorque

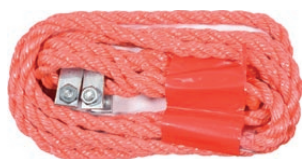

**VOREL**

No.	kg	
82206	3500	12

PL Linka holownicza z szeklą  
GB Tow rope  
D Abschleppseil  
RUS Трос автомобильный буксировочный

CZ Těžný provázek  
RO Șufă pt. remorcare  
H Vonatőkötél  
E Cable de remorque



**VOREL**

No.	kg	
82232	2500	16

PL Linka holownicza z hakiem  
GB Tow rope  
D Abschleppseil  
RUS Трос автомобильный буксировочный

CZ Těžný provázek  
RO Șufă pt. remorcare  
H Vonatőkötél  
E Cable de remorque



**VOREL**

No.	kg	
82231	1450	20

PL Szczotka do czyszczenia klemm  
GB Battery clamps cleaner  
D Klemmbürste  
RUS Щетка для зачистки клемм

CZ Kartáč pro čištění svorek  
RO Perie curatat borne auto  
D Akkumulátorsaru tisztító kefe  
E Cepillo para limpiar bornes



No.		
82440		10/160

PL Linka holownicza  
GB Tow rope  
D Abschleppseil  
RUS Трос автомобильный буксировочный

CZ Těžný provázek  
RO Șufă pt. remorcare  
H Vonatőkötél  
E Cable de remorque



**VOREL**

No.	kg	
82210	1500	20
82225	2500	20

PL Linka holownicza z szeklą  
GB Tow rope  
D Abschleppseil  
RUS Трос автомобильный буксировочный

CZ Těžný provázek  
RO Șufă pt. remorcare  
H Vonatőkötél  
E Cable de remorque



**VOREL**

No.	kg	
82234	3500	12

PL Linka holownicza z hakiem  
GB Tow rope  
D Abschleppseil  
RUS Трос автомобильный буксировочный

CZ Těžný provázek  
RO Șufă pt. remorcare  
H Vonatőkötél  
E Cable de remorque



**VOREL**

No.	kg	
82233	2500	16

PL Szczotka do czyszczenia klemm  
GB Battery clamps cleaner  
D Klemmbürste  
RUS Щетка для зачистки клемм

CZ Kartáč pro čištění svorek  
RO Perie curatat borne auto  
D Akkumulátorsaru tisztító kefe  
E Cepillo para limpiar bornes



**VOREL**

No.		
82445		10/100

PL Komplet klem do akumulatora  
GB Battery clamps  
D Aku-polklemmen  
RUS Клеммы аккумуляторные

CZ Sada svorek na akumulátor  
RO Set de cleme pt. acumulator  
H Akkumulátorsaru készlet  
E Juego de bomes para acumulador



No.	pcs packing	box
82431	2	12

PL Wiązka przewodów awaryjnych  
GB Boosters cables  
D Starthilfekabel  
RUS Старт-кабель

CZ Spouštěcí kabele  
RO Cabluri de alimentare  
H Indfókábel  
E Pinzas de arranque



No.	A	box
82501	120	6
82502	200	14
82504	400	6
82506	600	4

PL Szczotka do samochodu  
GB Eureka duster  
D Waschbürste  
RUS Щетка-моп для мытья машин

CZ Kartač na auto  
RO Perie pt. mașină  
H Autómosó kefe  
E Cepillo de coche



No.	box
82939	25/50

PL Lejek  
GB Flexible funnel  
D Trichter  
RUS Воронка гибкая

CZ Nálevka  
RO Pálnie  
H Kétrészes tölcsér  
E Embudo



No.	box
83000	40

PL Próbnik akumulatorowy  
GB Battery hydrometer  
D Batteriesäureprüfer  
RUS Ареометр аккумуляторный

CZ Akumulátorový zkoušeč  
RO Instrument de verificare acumulator  
H Akkumulátorpróbató  
E Probador de acumulador



No.	box
82520	10/100

PL Skrobaczka do szyb  
GB Car window scraper  
D Auto-Eiskratzer  
RUS Автомобильный скребок

CZ Škrabka na okna  
RO Razuitor gheata  
H Jégkaparó  
E Rascadora para cristales



No.	box
82910	100

PL Guma do szyb z drewnianą rączką  
GB Window squeegee  
D Scheibenreiniger-holzstiel  
RUS Стеклоочиститель с резинкой

CZ Guma do skel z dřevěnou rukojetí  
RO Lamă-ștergător cu minier de lemn pt. geamuri  
H Vízlehúzó gumi fa nyéllel  
E Goma para cristales con mango de madera



No.	box
82920	50

PL Lejek  
GB Flexible funnel  
D Trichter  
RUS Воронка гибкая

CZ Nálevka  
RO Pálnie  
H Kétrészes tölcsér  
E Embudo



No.	box
83001	50

PL Lejek  
GB Flexible funnel  
D Trichter  
RUS Воронка гибкая

CZ Nálevka  
RO Pálnie  
H Kétrészes tölcseér  
E Embudo



No.		
83002		30

PL Lejek  
GB Funnel  
D Trichter  
RUS Воронка

CZ Nálevka  
RO Pálnie  
H Kétrészes tölcseér  
E Embudo



No.	pcs	diameter / średnica (mm)	height / wysokość (mm)	
83005	4	52; 76; 100; 120	75; 110; 125; 152	30

PL Gaśnica samochodowa  
GB Powder fire extinguisher  
D Pulverlöscher  
RUS Огнетушитель порошковый автомобильный  
CZ Hasičící přístroj práškový  
RO Extinctör cu pudră  
H Porralöltő akasztóval  
E Extintor de polvo bc con soporte



No.	kg	
83270	1	10

PL Apteczka samochodowa  
GB First aid kit  
D Verbandkasten  
RUS Аптечка автомобильная

CZ Příruční lékárnička první pomoci  
RO Trusă medicală de prim-ajutor  
H Elsősegély doboz  
E Botiquin



No.	type	
83261	E-04	5

PL Lejek rolniczy  
GB Agricultural funnel  
D Landwirtschaftlich trichter  
RUS Сельскохозяйственная воронка

CZ Trychtýř zemědělský  
RO Pálnie agricole  
H Mezőgazdasági tölcseér  
E Embudo agrícola



No.	diameter / średnica (mm)	
83004	210	25

PL Odkurzacz samochodowy  
GB Car vacuum cleaner  
D Handsauger  
RUS Ручной пылесос для автомобиля

CZ Vysavač do auta  
RO Aspirator de masina  
H Autó porszívó  
E Aspirador para coche

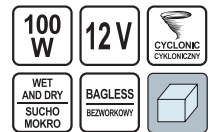

No.	W	V	
82951	100	12	8

PL Apteczka samochodowa  
GB First aid kit  
D Verbandkasten  
RUS Аптечка автомобильная

CZ Příruční lékárnička první pomoci  
RO Trusă medicală de prim-ajutor  
H Elsősegély doboz  
E Botiquin



No.	type	
83260	E-01	10

PL Apteczka samochodowa  
GB First aid kit  
D Verbandkasten  
RUS Аптечка автомобильная

CZ Příruční lékárnička první pomoci  
RO Trusă medicală de prim-ajutor  
H Elsősegély doboz  
E Botiquin



No.	type	
83262	E-03	5



- PL Apteczka metalowa  
GB Metal first aid kit  
D Apotheke aus Metall  
RUS Металлическая аптечка
- CZ Kovová lékárnička  
RO Trusă medicală din metal  
H Fém elsősegély doboz  
E Botiquín de metal



No.	type	dimensions / wymiary (mm)	pcs
83266	E240	240x220x120	1

- PL Trójkąt ostrzegawczy  
GB Vehicle safety triangle  
D Warndreieck  
RUS Предупреждающий треугольник
- CZ Výstražný trojúhelník  
RO Triunghi de avertizare  
H Elakadásjelző háromszög  
E Triángulo de emergencia



No.	pcs
83280	40

- PL Ściągacze elastyczne  
GB Elastic straps  
D Gummispannseil  
RUS Стяжка для багажа
- CZ Elastické spínatka  
RO Cordelina elastica  
H Rugalmas feszítő  
E Pulpos



No.	L (cm)	Ø (mm)	pcs packing	pcs
82308	80	8	2	20/80
82310	100	8	2	20/80
82315	150	8	2	20/80
82320	200	8	2	20/80

- PL Płaskie ściągacze elastyczne  
GB Elastic straps  
D Gummispannseil  
RUS Стяжка для багажа
- CZ Elastické spínatka  
RO Cordelina elastica  
H Rugalmas feszítő  
E Pulpos



No.	L (cm)	pcs packing	pcs
82360	80	2	25/50
82370	100	2	25/50

- PL Apteczka metalowa  
GB Metal first aid kit  
D Apotheke aus Metall  
RUS Металлическая аптечка
- CZ Kovová lékárnička  
RO Trusă medicală din metal  
H Fém elsősegély doboz  
E Botiquín de metal



No.	type	dimensions / wymiary (mm)	pcs
83267	E300	300x220x120	1

- PL Spinacz bagażu  
GB Elastic tie down  
D Gepäckspinnensatz  
RUS Стяжка для багажа-8 крючков
- CZ Elastické spínatka  
RO Cordelina elastica  
H Csomagrögzítő pók  
E Pulpo 8-ramion



No.	L (cm)	Ø (mm)	arms / ramiona	pcs
82300	80	8	8	25/50



No.	L (cm)	Ø (mm)	arms / ramiona	pcs
82301	80	8	8	25/50

- PL Ściągacze elastyczne  
GB Elastic straps  
D Gummispannseil  
RUS Стяжка для багажа
- CZ Elastické spínatka  
RO Cordelina elastica  
H Rugalmas feszítő  
E Pulpos



No.	L (cm)	Ø (mm)	pcs packing	pcs
82305	120	12	2	12/24

- PL Zestaw linek z szeklą do bagażu  
GB Loop and lock set  
D Seil mit Schäkkel für Gepäck, Satz  
RUS Набор канатов со скобами для багажа  
CZ Souprava upínačů zavazadel s karabinami  
RO Set de cordoane cu cârlige pt. bagaj  
H Gumipók  
E Juego de cuerdas con mosquetón para el equipaje



No.	L (cm)	pcs	pcs
82304	86	2	12/48

- PL Taśma do bagażu ze sprzączką
- GB Ratchet tie down
- D Spanggurt
- RUS Ремни для крепления груза с зажимом фиксатором
- CZ Pásy na zavazadla
- RO Cordelina pt. bagaje cu clicheț
- H Csomagrógzítő pánt
- E Cintas para equipaje

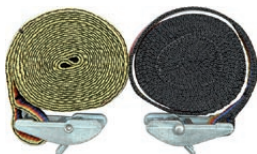

No.	L (cm)	W (mm)	pcs packing	Box
82331	250	25	2	10/80

- PL Taśma do bagażu
- GB Ratchet tie down
- D Spanggurt
- RUS Ремень для крепления багажа с трещоткой
- CZ Pás na zavazadla z napínáním
- RO Cordelina pt. bagaje cu clicheț
- H Csomagrógzítő pánt feszítővel
- E Cinta para equipaje con carraca



No.	L (m)	daN	W (mm)	Box
82377	2	1000	35	10
82378	4	1000	35	10
82379	6	1000	35	10
82380	8	1000	35	10

- PL Taśma do bagażu
- GB Ratchet tie down
- D Spanggurt
- RUS Ремень для крепления багажа с трещоткой
- CZ Pás na zavazadla z napínáním
- RO Cordelina pt. bagaje cu clicheț
- H Csomagrógzítő pánt feszítővel
- E Cinta para equipaje con carraca

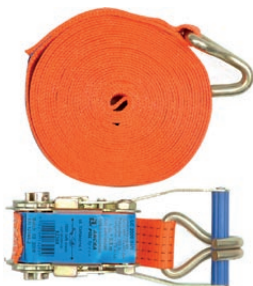

No.	L (m)	daN	W (mm)	Box
82372	4	1600	50	8
82373	6	1600	50	7
82374	8	1600	50	6
82375	10	1600	50	5
82384	6	2000	50	6
82386	8	2000	50	6
82388	10	2000	50	5
82390	12	2000	50	5

- PL Taśma do bagażu ze sprzączką
- GB Ratchet tie down
- D Spanggurt
- RUS Ремни для крепления груза с зажимом фиксатором
- CZ Pásy na zavazadla
- RO Cordelina pt. bagaje cu clicheț
- H Csomagrógzítő pánt
- E Cintas para equipaje



No.	L (m)	W (mm)	Box
82341	5	25	12/48

- PL Taśma do bagażu
- GB Ratchet tie down
- D Spanggurt
- RUS Ремень для крепления багажа с трещоткой
- CZ Pás na zavazadla z napínáním
- RO Cordelina pt. bagaje cu clicheț
- H Csomagrógzítő pánt feszítővel
- E Cinta para equipaje con carraca



No.	L (m)	W (mm)	Box
82351	5	25	12/48

- PL Taśma do bagażu
- GB Ratchet tie down
- D Spanggurt
- RUS Ремень для крепления багажа с трещоткой
- CZ Pás na zavazadla z napínáním
- RO Cordelina pt. bagaje cu clicheț
- H Csomagrógzítő pánt feszítővel
- E Cinta para equipaje con carraca



No.	L (m)	W (mm)	pcs packing	Box
82400	5	25	2	8/16

- PL Taśma do bagażu
- GB Ratchet tie down
- D Spanggurt
- RUS Ремень для крепления багажа с трещоткой
- CZ Pás na zavazadla z napínáním
- RO Cordelina pt. bagaje cu clicheț
- H Csomagrógzítő pánt feszítővel
- E Cinta para equipaje con carraca

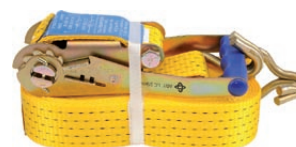

No.	L (m)	daN	W (mm)	Box
82392	6	2500	50	6
82393	8	2500	50	6
82395	12	2500	50	5

PL Taśma do bagażu  
GB Ratchet tie down  
D Spangurt  
RUS Ремень для крепления багажа с трещоткой

CZ Pás na zavazadla z napínáním  
RO Cordelina pt. bagaje cu clicheț  
H Csomagrögzítő pánt feszítővel  
E Cinta para equipaje con carraca



No.	L (m)	daN	W (mm)	
82343	4	1000	25	20

PL Plandeka  
GB Tarpaulin  
D Plane  
RUS Тент

CZ Plachta  
RO Husă  
H Ponyva  
E Toldo

57 g/m<sup>2</sup>



No.	m	g/m <sup>2</sup>	
85122	2x3	57	30
85123	3x5	57	20
85124	4x5	57	10
85125	4x6	57	8
85126	5x8	57	5
85128	6x10	57	3
85129	8x12	57	2
85130	10x15	57	2

PL Plandeka  
GB Tarpaulin  
D Plane  
RUS Тент

CZ Plachta  
RO Husă  
H Ponyva  
E Toldo



No.	m	g/m <sup>2</sup>	
85020	2x3	90	30
85030	3x5	90	18
85040	4x5	90	9
85050	4x6	90	10
85060	5x8	90	5
85080	6x10	90	4
85090	8x12	90	2
85100	10x15	90	1



PL Taśma do bagażu  
GB Ratchet tie down  
D Spangurt  
RUS Ремень для крепления багажа с трещоткой

CZ Pás na zavazadla z napínáním  
RO Cordelina pt. bagaje cu clicheț  
H Csomagrögzítő pánt feszítővel  
E Cinta para equipaje con carraca

2 PCS



No.	L (m)	daN	W (mm)	
82397	5	500	25	20

PL Plandeka  
GB Tarpaulin  
D Plane  
RUS Тент

CZ Plachta  
RO Husă  
H Ponyva  
E Toldo

75 g/m<sup>2</sup>



No.	m	g/m <sup>2</sup>	
85112	2x3	75	30
85113	3x5	75	10
85114	4x5	75	10
85115	4x6	75	8
85116	5x8	75	5
85118	6x10	75	3
85119	8x12	75	2
85120	10x15	75	2

90 g/m<sup>2</sup>





15

Power tools & accessories  
Elektronarzędzia i akcesoria

POWERUP

POWERUP

**Power tools POWER UP**  
Elektronarzędzia POWER UP



206-213

<b>Impact drills</b> Wiertarki udarowe.....	206
<b>Rotary hammers</b> Młoty udarowe.....	206
<b>Cordless tools</b> Urządzenia akumulatorowe.....	207
<b>Angle grinders</b> Szlifierki kątowe.....	208
<b>Multi-purpose oscillating tools</b> Wielofunkcyjne narzędzia oscylacyjne.....	208
<b>Orbital sanders</b> Szlifierki mimośrodowe.....	209
<b>Car polishers</b> Polerki samochodowe.....	209
<b>Jig saws</b> Wyrzynarki.....	209
<b>Sabre saws</b> Piły szablaste.....	209
<b>Circular saws</b> Pilarki tarczowe.....	210
<b>Planers</b> Strugi.....	210
<b>Hot air guns</b> Opalarki.....	210
<b>Glue guns</b> Pistolety do klejenia.....	210
<b>Spray guns</b> Pistolety natryskowe.....	211
<b>Soldering guns</b> Lutownice.....	211
<b>Paint &amp; mortar mixers</b> Mieszarki do zapraw i farb.....	212
<b>Bench tools</b> Elektronarzędzia stołowe.....	212
<b>Pipe welders</b> Zgrzewarki do rur.....	212
<b>Water pumps</b> Pompy wodne.....	213

**Power tools STHOR**  
Elektronarzędzia STHOR



214-220

<b>Impact drills</b> Wiertarki udarowe.....	214
<b>Rotary hammers</b> Młoty udarowe.....	214
<b>Cordless tools</b> Urządzenia akumulatorowe.....	215
<b>Impact wrenches</b> Klucze udarowe.....	216
<b>Angle grinders</b> Szlifierki kątowe.....	216
<b>Finishing sanders</b> Szlifierki oscylacyjne.....	217
<b>Jig saws</b> Wyrzynarki.....	217
<b>Circular saws</b> Pilarki tarczowe.....	217
<b>Hot air guns</b> Opalarki.....	217
<b>Glue guns</b> Pistolety do klejenia.....	218
<b>Spray guns</b> Pistolety natryskowe.....	218
<b>Industrial vacuum cleaners</b> Odkurzacze przemysłowe.....	218
<b>Soldering guns</b> Lutownice.....	218
<b>Bench tools</b> Elektronarzędzia stołowe.....	219
<b>Pipe welders</b> Zgrzewarki do rur.....	220

**Power tools LUND**  
**Elektronarzędzia LUND**

221-224



<b>Impact drills</b> Wiertarki udarowe.....	221
<b>Rotary hammers</b> Młoty udarowe.....	221
<b>Cordless tools</b> Urządzenia akumulatorowe.....	221
<b>Angle grinders</b> Szlifierki kątowe.....	221
<b>Finishing sanders</b> Szlifierki oscylacyjne.....	222
<b>Car polishers</b> Polerki samochodowe.....	222
<b>Jig saws</b> Wyrzynarki.....	222
<b>Circular saws</b> Pilarki tarczowe.....	223
<b>Hot air guns</b> Opalarki.....	223
<b>Glue guns</b> Pistolety do klejenia.....	223
<b>Soldering guns</b> Lutownice.....	224
<b>Pipe welders</b> Zgrzewarki do rur.....	224

**Power tools FLO**  
**Elektronarzędzia FLO**

225-227



<b>Cordless tools</b> Urządzenia akumulatorowe.....	225
<b>Water pumps</b> Pompy wodne.....	225
<b>Grass trimmers</b> Podkaszarki.....	226
<b>Hedge shears</b> Nożyce do żywopłotu.....	227

**Power tools**  
**Elektronarzędzia**

228

**Industrial vacuum cleaners**

Odkurzacze przemysłowe..... 228

**Soldering guns**

Lutownice..... 228

**Bench tools**

Elektronarzędzia stołowe..... 228

**Accessories**  
**Akcesoria**

229-235

**Grass trimmer lines**

Żyłki tnące do podkaszarek..... 229

**Discs**

Tarcze..... 231

**Drill chucks**

Uchwyty wiertarskie..... 231

**Adapters**

Adaptery..... 231

**Drill bit sharpeners**

Ostrzałki do wiertel..... 231

**Stands for power tools**

Statywy do elektronarzędzi..... 232

**Spare blades, brushes, etc. for power tools**

Zapasowe ostrza, szczotki, końcówki do elektronarzędzi..... 232

**Soldering iron accessories**

Akcesoria do lutownic..... 233

**Gasoline water pump accessories**

Akcesoria do pomp spalinowych..... 235

- PL Wiertarka udarowa
- GB Impact drill
- D Schlagbohrmaschine
- RUS Дрель ударная
- CZ Nárazová vrtáčka
- RO Masina de gaurit
- H Kezelési utasítás
- E Taladradora de percusión

230V~50Hz 710 W 13mm 0-2900 min<sup>-1</sup>



$L_{pa} = 92,0 \pm 3,0$  dB;  $L_{wa} = 103,0 \pm 3,0$  dB;  $a_n = 3,76 \pm 1,5 / 15,44 \pm 1,5$  m/s<sup>2</sup>

No.	W	min-1	
79013	710	0-2900	6

- PL Wiertarka udarowa
- GB Impact drill
- D Schlagbohrmaschine
- RUS Дрель ударная
- CZ Nárazová vrtáčka
- RO Masina de gaurit
- H Kezelési utasítás
- E Taladradora de percusión

230V~50Hz 1100 W 13mm 0-2800 min<sup>-1</sup>

CARBON BRUSH INDICATOR  
WSKAZNIK ZUŻYCIA SZCZOTEK

MOTOR DAMAGE INDICATOR  
WSKAZNIK ZWARCIA NA SILNIKU



$L_{pa} = 95,5 \pm 3,0$  dB;  $L_{wa} = 106,5 \pm 3,0$  dB;  $a_n = 3,42 \pm 1,5 / 17,74 \pm 1,5$  m/s<sup>2</sup>

No.	W	min-1	
79026	1100	0-2800	6

- PL Motowiertarka
- GB Rotary hammer
- D Bohrhammer
- RUS Перфоратор
- CZ Vrtací kladivo
- RO Ciocan rotopercutor
- H Fúrókalapács
- E Martillo perforador

230V~50Hz 1800 W 0-800 min<sup>-1</sup> 0-4000 min<sup>-1</sup>

IMPACT ENERGY 2.7J



$L_{pa} = 94,0 \pm 3,0$  dB;  $L_{wa} = 105,0 \pm 3,0$  dB;  $a_n = 19,190 \pm 1,5 / 14,760 \pm 1,5$  m/s<sup>2</sup>

No.	W	min-1	
79048	1800	0-800	2

- PL Wiertarka udarowa
- GB Impact drill
- D Schlagbohrmaschine
- RUS Дрель ударная
- CZ Nárazová vrtáčka
- RO Masina de gaurit
- H Kezelési utasítás
- E Taladradora de percusión

230V~50Hz 850 W 13mm 0-2800 min<sup>-1</sup>

CARBON BRUSH INDICATOR  
WSKAZNIK ZUŻYCIA SZCZOTEK

MOTOR DAMAGE INDICATOR  
WSKAZNIK ZWARCIA NA SILNIKU



$L_{pa} = 95,5 \pm 3,0$  dB;  $L_{wa} = 106,5 \pm 3,0$  dB;  $a_n = 3,42 \pm 1,5 / 17,74 \pm 1,5$  m/s<sup>2</sup>

No.	W	min-1	
79018	850	0-2800	6

- PL Młotowiertarka
- GB Rotary hammer
- D Bohrhammer
- RUS Перфоратор
- CZ Vrtací kladivo
- RO Ciocan rotopercutor
- H Fúrókalapács
- E Martillo perforador

230V~50Hz 800 W 0-1000 min<sup>-1</sup> 0-5000 min<sup>-1</sup>

IMPACT ENERGY 3.5J



$L_{pa} = 89,4 \pm 3,0$  dB;  $L_{wa} = 100,4 \pm 3,0$  dB;  $a_n = 14,936 \pm 1,5 / 14,898 \pm 1,5$  m/s<sup>2</sup>

No.	W	min-1	
79053	800	0-1000	2

- PL Młotowiertarka
- GB Rotary hammer
- D Bohrhammer
- RUS Перфоратор
- CZ Vrtací kladivo
- RO Ciocan rotopercutor
- H Fúrókalapács
- E Martillo perforador

230V~50Hz 1200 W 300-600 min<sup>-1</sup> 1950-3900 min<sup>-1</sup>

IMPACT ENERGY 2.8J



$L_{pa} = 92,2 \pm 3,0$  dB;  $L_{wa} = 103,2 \pm 3,0$  dB;  $a_n = 11,826 \pm 1,5 / 9,602 \pm 1,5$  m/s<sup>2</sup>

No.	W	min-1	
79047	1200	300-600	2



- PL Zakrećarka udarowa
- GB Impact wrench
- D Schlagschrauber
- RUS Ударный гайковерт
- CZ Rázový šroubovák
- RO Mașină de infilțat cu percute
- H Ütvecsavarozó
- E Atomillador de impacto

90 Nm 0-2300 min<sup>-1</sup> 12 V HEX 6.3 mm

2000 mAh Li-Ion



$L_{pa} = 91,37 \pm 3,0$  dB;  $L_{wa} = 102,37 \pm 3,0$  dB;  $a_n = 1,99 \pm 1,5$  m/s<sup>2</sup>

No.	V	min-1	Ø (mm)
78960	12	0-2300	10

- PL Wiertarko-wkręćarka akumulatorowa
- GB Cordless drill
- D Akkuschauber
- RUS Аккумуляторная дрель-шуруповерт
- CZ Vrtáčko-utahovák akumulátorový
- RO Bormașină-șurubelniță cu acumulator
- H Akkumulátoros fűrógép-csavarbehajtó
- E Taladradora - atomilladora acu.

18 Nm 0-350 min<sup>-1</sup> / 0-1200 min<sup>-1</sup> 14.4 V 10 mm

Li-Ion 1h QUICK CHARGING



$L_{pa} = 63,60 \pm 3,0$  dB;  $L_{wa} = 74,60 \pm 3,0$  dB;  $a_n = 1,068 \pm 1,5 / 1,956 \pm 1,5$  m/s<sup>2</sup>

No.	V	min-1	Ø (mm)
78971	14.4	0-350 / 0-1200	10

- PL Akumulator
- GB Battery
- D Akkumulator
- RUS Аккумулятор
- CZ Akumulátor
- RO Acumulatorul
- H Akkumulátor
- E Acumulador

Li-Ion 1h QUICK CHARGING 1300 mAh



No.	V	for / dla
78975	10.8	78970
78976	14.4	78971
78977	18	78973

- PL Wiertarko-wkręćarka akumulatorowa
- GB Cordless drill
- D Akkuschauber
- RUS Аккумуляторная дрель-шуруповерт
- CZ Vrtáčko-utahovák akumulátorový
- RO Bormașină-șurubelniță cu acumulator
- H Akkumulátoros fűrógép-csavarbehajtó
- E Taladradora - atomilladora acu.

16 Nm 0-350 min<sup>-1</sup> / 0-1300 min<sup>-1</sup> 10.8 V 10 mm

Li-Ion 1h QUICK CHARGING



$L_{pa} = 66,9 \pm 3,0$  dB;  $L_{wa} = 77,9 \pm 3,0$  dB;  $a_n = 0,473 \pm 1,5$  m/s<sup>2</sup>

No.	V	min-1	Ø (mm)
78970	10.8	0-350 / 0-1300	10

- PL Wiertarko-wkręćarka akumulatorowa
- GB Cordless drill
- D Akkuschauber
- RUS Аккумуляторная дрель-шуруповерт
- CZ Vrtáčko-utahovák akumulátorový
- RO Bormașină-șurubelniță cu acumulator
- H Akkumulátoros fűrógép-csavarbehajtó
- E Taladradora - atomilladora acu.

21 Nm 0-350 min<sup>-1</sup> / 0-1200 min<sup>-1</sup> 18 V 10 mm

Li-Ion 1h QUICK CHARGING



$L_{pa} = 66,20 \pm 3,0$  dB;  $L_{wa} = 77,20 \pm 3,0$  dB;  $a_n = 1,360 \pm 1,5 / 2,347 \pm 1,5$  m/s<sup>2</sup>

No.	V	min-1	Ø (mm)
78973	18	0-350 / 0-1200	10

- PL Ładowarka
- GB Battery charger
- D Ladegerät
- RUS Зарядное устройство
- CZ Nabíječka baterií
- RO Redresor
- H Akkumulátortöltő
- E Rectificador

230V/50Hz BATTERY CHARGER LADOWARKA for/dla: Li-Ion



No.	for / dla	for / dla
78978	10.8	78970; 78975
78979	14.4	78971; 78976
78980	18	78973; 78977

- PL Szlifierka kątowa
- GB Angle grinder
- D Winkelschleifmaschine
- RUS Углошлифовальная машинка
- CZ Úhlová bruska
- RO Polizor unghiular
- H Sarokcsiszoló
- E Lijadera de angulo

230V~ 50Hz	600 W	12000min <sup>-1</sup>
115mm	M14	
LONG LIFE MOTOR WYTRZYMAŁY SIENIK	POWER OFF PROTECTION SWITCH BEZPIECZNY WŁĄCZNIK	ERGO BODY ERGONOMIACZNA OBLÓDKA



$L_{pA} = 88,2 \pm 3,0$  dB;  $L_{wA} = 99,2 \pm 3,0$  dB;  $a_n = 5,27 \pm 1,5$  m/s<sup>2</sup>

No.	W	min-1	
79099	600	12000	6

- PL Szlifierka kątowa
- GB Angle grinder
- D Winkelschleifmaschine
- RUS Углошлифовальная машинка
- CZ Úhlová bruska
- RO Polizor unghiular
- H Sarokcsiszoló
- E Lijadera de angulo

230V~ 50Hz	1400 W	8000min <sup>-1</sup>	180mm	M14
LED	CARBON BRUSH INDICATOR WSKAZNIK ZUŻYCIA SZCZOTEK	MOTOR DAMAGE INDICATOR WSKAZNIK ZWAGIĘCIA NA BRAMKI		



$L_{pA} = 86,0 \pm 3,0$  dB;  $L_{wA} = 97,0 \pm 3,0$  dB;  $a_n = 11,75 \pm 1,5$  m/s<sup>2</sup>

No.	W	min-1	
79129	1400	8000	4

- PL Pilarka dwutarczowa
- GB Double blade saw
- D Säge mit zwei Sägeblättern
- RUS Многоцелевая двухдисковая пила
- CZ Dvoukotoučová protiběžná pila
- RO Ferăstrău cu două discuri
- H Kéttárcsás daraboló
- E Máquina de serrar de dos discos

230V~ 50Hz	900 W	4200min <sup>-1</sup>	Ø125mm x2
130mm	STEEL STAL		
WOOD DREWNO	PVC		



$L_{pA} = 90,0 \pm 3,0$  dB;  $L_{wA} = 101,0 \pm 3,0$  dB;  $a_n = 3,616 \pm 1,5 / 4,437 \pm 1,5$  m/s<sup>2</sup>

No.	W	min-1	
79255	900	4200	4

- PL Szlifierka kątowa
- GB Angle grinder
- D Winkelschleifmaschine
- RUS Углошлифовальная машинка
- CZ Úhlová bruska
- RO Polizor unghiular
- H Sarokcsiszoló
- E Lijadera de angulo

230V~ 50Hz	900 W	12000min <sup>-1</sup>
125mm	M14	
LONG LIFE MOTOR WYTRZYMAŁY SIENIK	POWER OFF PROTECTION SWITCH BEZPIECZNY WŁĄCZNIK	ERGO BODY ERGONOMIACZNA OBLÓDKA



$L_{pA} = 90,7 \pm 3,0$  dB;  $L_{wA} = 101,7 \pm 3,0$  dB;  $a_n = 6,39 \pm 1,5$  m/s<sup>2</sup>

No.	W	min-1	
79118	900	12000	6

- PL Szlifierka kątowa
- GB Angle grinder
- D Winkelschleifmaschine
- RUS Углошлифовальная машинка
- CZ Úhlová bruska
- RO Polizor unghiular
- H Sarokcsiszoló
- E Lijadera de angulo

230V~ 50Hz	2300 W	6200min <sup>-1</sup>	230mm
M14			



$L_{pA} = 94,0 \pm 3,0$  dB;  $L_{wA} = 105,0 \pm 3,0$  dB;  $a_n = 6,04 \pm 1,5$  m/s<sup>2</sup>

No.	W	min-1	
79141	2300	6200	2

- PL Wielofunkcyjne narzędzie oscylacyjne
- GB Multi-purpose oscillating tool
- D Multifunktionales Oszillationswerkzeug
- RUS Многофункциональный инструмент
- CZ Multifunkční oscilační nářadí
- RO Unealtă multifuncțională oscilantă
- H Multifunkciós rezgő szerszám
- E Herramienta oscilatoria multiusos

230V~ 50Hz	250 W	21000min <sup>-1</sup>



$L_{pA} = 86,0 \pm 3,0$  dB;  $L_{wA} = 97,0 \pm 3,0$  dB;  $a_n = 6,48 \pm 1,5$  m/s<sup>2</sup>

No.	W	min-1	
79237	250	21000	12

- PL Wielofunkcyjne narzędzie oscylacyjne
- GB Multi-purpose oscillating tool
- D Multifunktionales Oszillationswerkzeug
- RUS Многофункциональный инструмент
- CZ Multifunkční oscilační nářadí
- RO Unealtă multifuncțională oscilantă
- H Multifunkciós rezgő szerszám
- E Herramienta oscilatoria multiusos

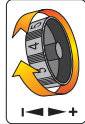
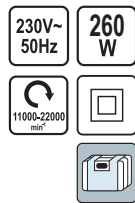

$L_{pa} = 80,0 \pm 3,0$  dB;  $L_{wa} = 91,0 \pm 3,0$  dB;  $a_h = 3,96 \pm 1,5$  m/s<sup>2</sup>

No.	W	min-1	Icon
79238	260	11000-22000	6

- PL Polerka samochodowa
- GB Car polisher
- D Autopoliermaschine
- RUS Полировальная машина
- CZ Leštička na automobily
- RO Masina de lustruit automobile
- H Gépkocsi polirozógép
- E Máquina para pulir coches



$L_{pa} = 85,0 \pm 3,0$  dB;  $L_{wa} = 96,0 \pm 3,0$  dB;  $a_h = 11,59 \pm 1,5$  m/s<sup>2</sup>

No.	W	min-1	Icon
78950	1400	3000	4

- PL Wyrzynarka
- GB Electric jig saw
- D Stichsäge
- RUS Лобзик электрический
- CZ Elektrická vyřezávací pila
- RO Fierastrau pendular
- H Elektromos dekopír fűrész
- E Cortadora eléctrica

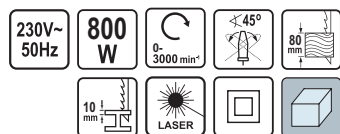

$L_{pa} = 85,78 \pm 3,0$  dB;  $L_{wa} = 96,78 \pm 3,0$  dB;  $a_h = 15,063 \pm 1,5 / 20,492 \pm 1,5$  m/s<sup>2</sup>

No.	W	min-1	Icon
79478	800	0-3000	10

- PL Szlifierka mimośrodowa
- GB Orbital sander
- D Exzentrische Schleifmaschine
- RUS Эксцентриковая шлифовальная машина
- CZ Excentrická bruska
- RO Polizor cu excentric
- H Excenter csiszoló
- E Pulidor excentrico

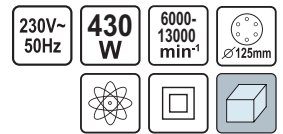

$L_{pa} = 81,0 \pm 3,0$  dB;  $L_{wa} = 92,0 \pm 3,0$  dB;  $a_h = 10,8 \pm 1,5$  m/s<sup>2</sup>

No.	W	min-1	Icon
79309	430	6000-13000	6

- PL Wyrzynarka
- GB Electric jig saw
- D Stichsäge
- RUS Лобзик электрический
- CZ Elektrická vyřezávací pila
- RO Fierastrau pendular
- H Elektromos dekopír fűrész
- E Cortadora eléctrica

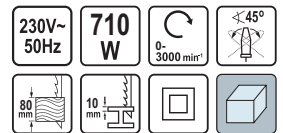

$L_{pa} = 95,0 \pm 3,0$  dB;  $L_{wa} = 106,0 \pm 3,0$  dB;  $a_h = 13,21 \pm 1,5 / 5,63 \pm 1,5$  m/s<sup>2</sup>

No.	W	min-1	Icon
79477	710	0-3000	10

- PL Pila szablata
- GB Sabre saw
- D Stichsäge
- RUS Сабельная пила
- CZ Šavlová pila
- RO Ferăstrău electric
- H Szablyafűrész
- E Sierra de sable

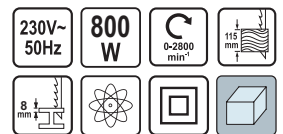

$L_{pa} = 88,0 \pm 3,0$  dB;  $L_{wa} = 99,0 \pm 3,0$  dB;  $a_h = 11,34 \pm 1,5 / 12,15 \pm 1,5$  m/s<sup>2</sup>

No.	W	min-1	Icon
79475	800	0-2800	4

PL Pilarka ręczna  
GB Circular saw  
D Handkreissäge  
RUS Пила циркулярная ручная  
CZ Pila kotoučová  
RO Fierastrau circular  
H Kézi körfűrészgép  
E Sierra de disco

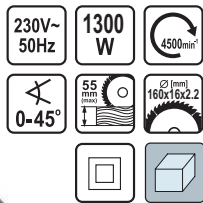

POWERUP

 $L_{pa} = 95,5 \pm 3,0 \text{ dB}; L_{wa} = 106,5 \pm 3,0 \text{ dB}; a_n = 1,749 \pm 1,5 / 2,462 \pm 1,5 \text{ m/s}^2$ 

No.	W	min-1	
79252	1300	4500	4

PL Strug elektryczny do drewna  
GB Electric planer  
D Elektro-höbel  
RUS Электрорубанок  
CZ Elektrický hoblík  
RO Rindea electrică manuală  
H Elektromos gyalu  
E Limadora eléctrica

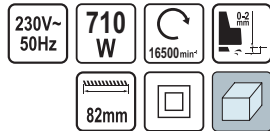

POWERUP

 $L_{pa} = 77,0 \pm 3,0 \text{ dB}; L_{wa} = 88,0 \pm 3,0 \text{ dB}; a_n = 7,47 \pm 1,5 \text{ m/s}^2$ 

No.	W	min-1	
79413	710	16500	4

PL Opalarka z akcesoriami  
GB Hot air gun with accessories  
D Heissluftpistole  
RUS Фен технический в наборе

CZ Opalovací stroj w s příslušenstvím  
RO Fion cu accesorii pt. ars vopseaua  
H Hőlégtűvő tartozékokkal  
E Secadora con accesorios

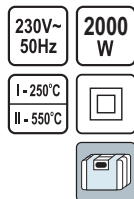

POWERUP

No.	W	°C	
79329	2000	250-550	5

PL Pilarka ręczna  
GB Circular saw  
D Handkreissäge  
RUS Пила циркулярная ручная  
CZ Pila kotoučová  
RO Fierastrau circular  
H Kézi körfűrészgép  
E Sierra de disco

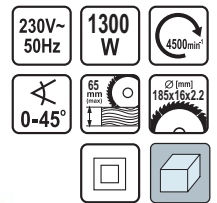

POWERUP

 $L_{pa} = 95,5 \pm 3,0 \text{ dB}; L_{wa} = 106,5 \pm 3,0 \text{ dB}; a_n = 1,749 \pm 1,5 / 2,462 \pm 1,6 \text{ m/s}^2$ 

No.	W	min-1	
79253	1300	4500	4

PL Strug elektryczny do drewna  
GB Electric planer  
D Elektro-höbel  
RUS Электрорубанок  
CZ Elektrický hoblík  
RO Rindea electrică manuală  
H Elektromos gyalu  
E Limadora eléctrica



POWERUP

 $L_{pa} = 91,2 \pm 3,0 \text{ dB}; L_{wa} = 102,2 \pm 3,0 \text{ dB}; a_n = 4,130 \pm 1,5 \text{ m/s}^2$ 

No.	W	min-1	
79410	900	16000	6

PL Pistolet do klejenia  
GB Electric glue gun  
D Heissklebepistole  
RUS Пистолет для клея

CZ Pistole na lepení  
RO Pistol pt. lipit  
H Ragasztópisztoly  
E Pistola de cola

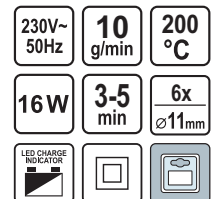

POWERUP

No.	W	
73058	16	10

PL Pistolet do klejenia  
GB Electric glue gun  
D Heissklebepistole  
RUS Пистолет для клея

CZ Pistole na lepení  
RO Pistol pt. lipit  
H Ragasztópisztoly  
E Pistola de cola



230V~ 50Hz	8-12 g/min	200 °C	15 (40) W
3-5 min	2x ∅11mm		



No.	W	
73056	15 (40)	6/48

PL Pistolet do klejenia  
GB Electric glue gun  
D Heissklebepistole  
RUS Пистолет для клея

CZ Pistole na lepení  
RO Pistol pt. lipit  
H Ragasztópisztoly  
E Pistola de cola

230V~ 50Hz	14-16 g/min	200 °C
23 (80) W	3-5 min	2x ∅11mm
		



No.	W	
73057	23 (80)	6/48

PL Lutownica oporowa  
GB Soldering iron  
D Delitkolben  
RUS Электрорпаяльник

CZ Pájka odporová  
RO Ciocan de lipit  
H Huforrasztópáka  
E Soldador de resistencia



230V~ 50Hz	400° C
5-10 min	



No.	W	∅ (mm)	
79382	40	5	25/50
79383	60	6	25/50

PL Pistolet do klejenia  
GB Electric glue gun  
D Heissklebepistole  
RUS Пистолет для клея



CZ Pistole na lepení  
RO Pistol pt. lipit  
H Ragasztópisztoly  
E Pistola de cola

230V~ 50Hz	15 g/min	200 °C
20 (80) W	3-5 min	3x ∅11mm
		



No.	W	
73059	20 (80)	12/48

PL Elektryczny pistolet natryskowy  
GB Electric spray gun  
D Elektro farbspritzpistole  
RUS Электрический пульверизатор  
CZ Elektrická pistole malířská  
RO Pistol de vopsit - electric  
H Elektromos festékszoro pisztoly  
E Pistola de pintar electr.

230V~ 50Hz	500 W	0.85 l/min
700 ml	HVLP	
		



$L_{pa} = 76,93 \pm 3,0$  dB;  $L_{min} = 87,93 \pm 3,0$  dB;  $a_w = 1,564 \pm 1,5$  m/s<sup>2</sup>

No.	W	
79764	500	4

PL Lutownica oporowa  
GB Soldering iron  
D Delitkolben  
RUS Электрорпаяльник

CZ Pájka odporová  
RO Ciocan de lipit  
H Huforrasztópáka  
E Soldador de resistencia

230V~ 50Hz	100 W	400° C
5-10 min	∅ 8 mm	



No.	W	∅ (mm)	
79385	100	8	25/50

PL Stacja lutownicza  
GB Soldering station  
D Lötstation  
RUS Паяльная станция

CZ Letovací stanice  
RO Stație de lipit  
H Forrasztópáka állomás  
E Estación de soldadura

230V  
~50Hz

35(48)  
W

150÷420  
°C

5 mm



No.	W	Icon
79379	35 (48)	8

PL Lutownica transformatorowa  
GB Transformer soldering gun  
D Lötspistole  
RUS Паяльник электрический

CZ Transformátorová páječka  
RO Pistol de lipit + accesorii  
H Forrasztópáka  
E Soldador transformador

230V~  
50Hz

200  
W



No.	W	Icon
79353	200	10

PL Szlifierka stolowa  
GB Bench grinder  
D Doppelschleifmaschine  
RUS Станок точильный

CZ Stůlní bruska  
RO Polizor de banc  
H Asztali kőszőrű  
E Lijadera de mesa

230V~  
50Hz

150  
W

2950  
min<sup>-1</sup>



$L_{pa} = 62,6 \pm 3,0$  dB;  $L_{wa} = 75,6 \pm 3,0$  dB

No.	W	min-1	Icon
79203	150	2950	1

PL Komplet grotów do stacji lutowniczej  
GB Spare soldering tips  
D Lötspitze  
RUS Наконечник паяльника

CZ Hrot do letovačky  
RO Vârf pt. ciocanul de lipit  
H Pákahegy  
E Pico soldador

3  
pcs

∅ 5 mm  
50.2mm

35(48)  
W

420  
°C

for/dla:  
79379



No.	W	pcs	R	for / dla	Icon
79380	35 (48)	3	0.4; 0.8; 1.2	79379	400
79381	35 (48)	3	1.6; 1.6; 3.2	79379	400

PL Mieszarka do zapraw  
GB Hand mixer  
D Mörtelmischgerät  
RUS Растворомешалка  
CZ Ruční míchačka na maltu  
RO Malaxor pt. mortar  
H Habarcskeverő  
E Mezcladora de mortero

230V~  
50Hz

1220  
W

0-700  
min<sup>-1</sup>

M14



$L_{pa} = 85,0 \pm 3,0$  dB;  $L_{wa} = 96,0 \pm 3,0$  dB;  $a_w = 2,92 \pm 1,5$  m/s<sup>2</sup>

No.	W	Icon
78852	1220	2

PL Zgrzewarka do rur termoplastycznych  
GB PVC plastic pipe welder  
D Schweissgerät für thermoplastische Rohre  
RUS Сварочная машина для термопластиковых труб  
CZ Svářečka na termoplastické trubky  
RO Hegesztő berendezés termoplasztikus csövekhez  
H Masina de sudat tevi termoplastice  
E Máquina de soldar las tubos termoplasticos

230V~  
50Hz

∅ [mm]  
16  
20, 25, 32  
40, 50, 63

IPX4

I-800W  
II-1500W

0-300  
°C



No.	W	Icon
78910	800-1500	5

- PL Pompa membranowa zatapialna
- GB Membrane deep well water pump
- D Tauchmotorpumpe
- RUS Погружной насос
- CZ Zátavnací čerpadlo
- RO Pompă pt. apă cu membrană
- H Búvárszivattyú
- E Bomba de diafragma sumergible

230V~ 50Hz	280 W	H max 60 m
1/2" 12.5mm	1080 l/h	



No.	W	l/h	
79942	280	1080	4

- PL Pompa zatapialna do wody brudnej
- GB Dirty water submersible pump
- D Tauchmotorpumpe
- RUS Погружной насос
- CZ Zátavnací čerpadlo
- RO Pompă pt. apă murdară
- H Búvárszivattyú
- E Bomba de inmersión para agua sucia

230V~ 50Hz	400 W	H max 6.0 m	6000 l/h
1" 25mm	5/4" 32mm	1.5" 38mm	



No.	W	l/h	
79909	400	6000	6

- PL Pompa zatapialna do wody brudnej
- GB Dirty water submersible pump
- D Tauchmotorpumpe
- RUS Погружной насос
- CZ Zátavnací čerpadlo
- RO Pompă pt. apă murdară
- H Búvárszivattyú
- E Bomba de inmersión para agua sucia

230V~ 50Hz	400 W	H max 5.0 m
5/4" 32mm	6500 l/h	



No.	W	l/h	
79903	400	6500	4

- PL Pompa zatapialna do wody brudnej
- GB Dirty water submersible pump
- D Tauchmotorpumpe
- RUS Погружной насос
- CZ Zátavnací čerpadlo
- RO Pompă pt. apă murdară
- H Búvárszivattyú
- E Bomba de inmersión para agua sucia

230V~ 50Hz	1" 25mm	5/4" 32mm	1.5" 38mm	
---------------	------------	--------------	--------------	---



No.	W	l/h	H (max)	
79904	550	10000	7	4
79905	750	12500	8	4
79906	900	14000	9	4
79907	1100	15000	10	4

	Memo
--	------

- PL Wiertarka udarowa
- GB Impact drill
- D Schlagbohrmaschine
- RUS Дрель ударная
- CZ Nárazová vrtačka
- RO Masina de gaurit
- H Kezelési utasítás
- E Taladradora de percusión

230V~ 50Hz	580 W	13mm	0-3000 min <sup>-1</sup>



$L_{pa} = 91,0 \pm 3,0$  dB;  $L_{wa} = 102,0 \pm 3,0$  dB;  $a_h = 2,64 \pm 1,5 / 10,81 \pm 1,5$  m/s<sup>2</sup>

No.	W	min-1	
79002	580	0-3000	10

- PL Wiertarka udarowa
- GB Impact drill
- D Schlagbohrmaschine
- RUS Дрель ударная
- CZ Nárazová vrtačka
- RO Masina de gaurit
- H Kezelési utasítás
- E Taladradora de percusión

230V~ 50Hz	650 W	13mm	0-2800 min <sup>-1</sup>



$L_{pa} = 79,0 \pm 3,0$  dB;  $L_{wa} = 90,0 \pm 3,0$  dB;  $a_h = 2,67 \pm 1,5 / 8,00 \pm 1,5$  m/s<sup>2</sup>

No.	W	min-1	
79007	650	0-2800	10

- PL Wiertarka udarowa
- GB Impact drill
- D Schlagbohrmaschine
- RUS Дрель ударная
- CZ Nárazová vrtačka
- RO Masina de gaurit
- H Kezelési utasítás
- E Taladradora de percusión

230V~ 50Hz	910 W	13mm	0-3000 min <sup>-1</sup>



$L_{pa} = 78,0 \pm 3,0$  dB;  $L_{wa} = 89,0 \pm 3,0$  dB;  $a_h = 2,93 \pm 1,5 / 8,43 \pm 1,5$  m/s<sup>2</sup>

No.	W	min-1	
79023	910	0-3000	10

- PL Wiertarka udarowa
- GB Impact drill
- D Schlagbohrmaschine
- RUS Дрель ударная
- CZ Nárazová vrtačka
- RO Masina de gaurit
- H Kezelési utasítás
- E Taladradora de percusión

230V~ 50Hz	600 W	13mm	0-3000 min <sup>-1</sup>



$L_{pa} = 88,0 \pm 3,0$  dB;  $L_{wa} = 99,0 \pm 3,0$  dB;  $a_h = 2,86 \pm 1,5 / 8,67 \pm 1,5$  m/s<sup>2</sup>

No.	W	min-1	
79005	600	0-3000	6

- PL Wiertarka udarowa
- GB Impact drill
- D Schlagbohrmaschine
- RUS Дрель ударная
- CZ Nárazová vrtačka
- RO Masina de gaurit
- H Kezelési utasítás
- E Taladradora de percusión

230V~ 50Hz	710 W	13mm	0-3000 min <sup>-1</sup>



$L_{pa} = 91,1 \pm 3,0$  dB;  $L_{wa} = 102,1 \pm 3,0$  dB;  $a_h = 2,48 \pm 1,5 / 14,67 \pm 1,5$  m/s<sup>2</sup>

No.	W	min-1	
79012	710	0-3000	10

- PL Młot udarowy
- GB Rotary hammer
- D Bohrhammer
- RUS Перфоратор
- CZ Přeřezací kladivo
- RO Ciocan percutant
- H Fűrókalapács-gép
- E Martillo de percusión

230V~ 50Hz	850 W	800 min <sup>-1</sup>			3150 min <sup>-1</sup>
SDS+					



$L_{pa} = 96,1 \pm 3,0$  dB;  $L_{wa} = 107,1 \pm 3,0$  dB;  $a_h = 24,184 \pm 1,5$  m/s<sup>2</sup>

No.	W	min-1	
79030	850	800	3



- PL Młot udarowy  
 GB Rotary hammer  
 D Bohrhämmer  
 RUS Перфоратор
- CZ Přeřezací kladivo  
 RO Ciocan percutatnt  
 H Fúrókalapács-gép  
 E Martillo de percusión

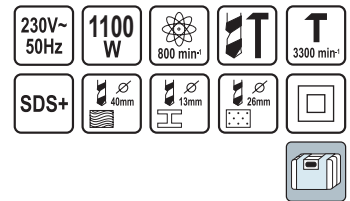

$L_{pa} = 92,6 \pm 3,0$  dB;  $L_{wa} = 103,6 \pm 3,0$  dB;  
 $a_s = 19,257$  (14,718)  $\pm 1,5$  / 15,241 (11,326)  $\pm 1,5$  m/s<sup>2</sup>

No.	W	min-1	
79036	1100	800	3

- PL Wiertarko-wkrętarzka akumulatorowa  
 GB Cordless drill  
 D Akkuschauber  
 RUS Аккумуляторная дрель-шурупверт  
 CZ Vrtáčko-utahovák akumulátorový  
 RO Bormășină-șurubelniță cu acumulator  
 H Akkumulátoros fúrógép-csavarbehajtó  
 E Taladradora - atomilladora acu.



$L_{pa} = 89,0 \pm 3,0$  dB;  $L_{wa} = 100,0 \pm 3,0$  dB;  $a_s = 0,854 \pm 1,5$  / 2,069  $\pm 1,5$  m/s<sup>2</sup>

No.	V	min-1	Ø (mm)	
78981	10.8	0-700	0.8-10	5

- PL Wiertarko-wkrętarzka akumulatorowa  
 GB Cordless drill  
 D Akkuschauber  
 RUS Аккумуляторная дрель-шурупверт  
 CZ Vrtáčko-utahovák akumulátorový  
 RO Bormășină-șurubelniță cu acumulator  
 H Akkumulátoros fúrógép-csavarbehajtó  
 E Taladradora - atomilladora acu.

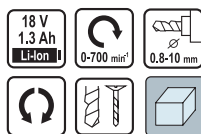

$L_{pa} = 89,0 \pm 3,0$  dB;  $L_{wa} = 100,0 \pm 3,0$  dB;  $a_s = 1,001 \pm 1,5$  / 2,629  $\pm 1,5$  m/s<sup>2</sup>

No.	V	min-1	Ø (mm)	
78983	18	0-700	0.8-10	5

- PL Wiertarko-wkrętarzka akumulatorowa  
 GB Cordless drill  
 D Akkuschauber  
 RUS Аккумуляторная дрель-шурупверт  
 CZ Vrtáčko-utahovák akumulátorový  
 RO Bormășină-șurubelniță cu acumulator  
 H Akkumulátoros fúrógép-csavarbehajtó  
 E Taladradora - atomilladora acu.



$L_{pa} = 87,0 \pm 3,0$  dB;  $L_{wa} = 98,0 \pm 3,0$  dB;  $a_s = 1,292 \pm 1,5$  / 2,312  $\pm 1,5$  m/s<sup>2</sup>

No.	V	min-1	Ø (mm)	
78982	14.4	0-700	0.8-10	5

- PL Akumulator  
 GB Battery  
 D Akkumulator  
 RUS Аккумулятор  
 CZ Akumulátor  
 RO Acumulatorul  
 H Akkumulátor  
 E Acumulador



No.	V	for / dia	
78985	10.8	78981	50
78986	14.4	78982	50
78987	18	78983	50

- PL Ładowarka  
GB Battery charger  
D Ladegerät  
RUS Зарядное устройство
- CZ Nabíječka baterii  
RO Redresor  
H Akkumulátortöltő  
E Rectificador



**STHOR**

No.		for / dla	
79087	15V --- 400mA	79084	30
79088	18V --- 400mA	79085	30
79089	24V --- 400mA	79086	20

- PL Szlifierka kątowa  
GB Angle grinder  
D Winkelschleifmaschine  
RUS Углошлифовальная машинка
- CZ Úhlová bruska  
RO Polizor unghiular  
H Sarokcsiszoló  
E Lijadera de angulo

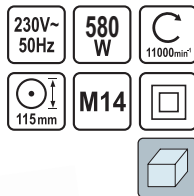

15

**STHOR**

$L_{pa} = 84,0 \pm 3,0$  dB;  $L_{wa} = 95,0 \pm 3,0$  dB;  $a_n = 2,87 \pm 1,5$  m/s<sup>2</sup>

No.	W	min-1	
79104	580	11000	10

- PL Szlifierka kątowa  
GB Angle grinder  
D Winkelschleifmaschine  
RUS Углошлифовальная машинка
- CZ Úhlová bruska  
RO Polizor unghiular  
H Sarokcsiszoló  
E Lijadera de angulo

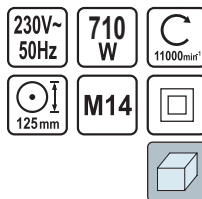

**STHOR**

$L_{pa} = 88,0 \pm 3,0$  dB;  $L_{wa} = 92,5 \pm 3,0$  dB;  $a_n = 3,44 \pm 1,5$  m/s<sup>2</sup>

No.	W	min-1	
79108	710	11000	10

- PL Elektryczny klucz udarowy  
GB Electric impact wrench  
D Elektro-Schlagschrauber  
RUS Электрический гайковерт  
CZ Elektrický rázový utahovák  
RO Cheie electrică  
H Elektromos ütvecsavarozó  
E llave de impacto eléctrica

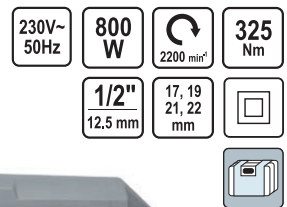

**STHOR**

$L_{pa} = 87,5 \pm 3,0$  dB;  $L_{wa} = 98,5 \pm 3,0$  dB;  $a_n = 9,93 \pm 1,5$  m/s<sup>2</sup>

No.	W	min-1	
57091	800	2200	5

- PL Szlifierka kątowa  
GB Angle grinder  
D Winkelschleifmaschine  
RUS Углошлифовальная машинка
- CZ Úhlová bruska  
RO Polizor unghiular  
H Sarokcsiszoló  
E Lijadera de angulo

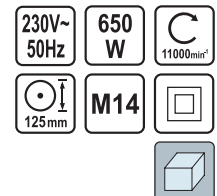

**STHOR**

$L_{pa} = 88,0 \pm 3,0$  dB;  $L_{wa} = 99,0 \pm 3,0$  dB;  $a_n = 3,43 \pm 1,5$  m/s<sup>2</sup>

No.	W	min-1	
79105	650	11000	10

- PL Szlifierka kątowa  
GB Angle grinder  
D Winkelschleifmaschine  
RUS Углошлифовальная машинка
- CZ Úhlová bruska  
RO Polizor unghiular  
H Sarokcsiszoló  
E Lijadera de angulo

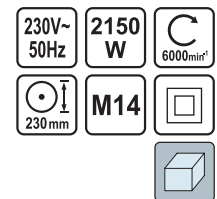

**STHOR**

$L_{pa} = 95,0 \pm 3,0$  dB;  $L_{wa} = 106,0 \pm 3,0$  dB;  $a_n = 6,17 \pm 1,5$  m/s<sup>2</sup>

No.	W	min-1	
79140	2150	6000	2

- PL Szlifierka oscylacyjna
- GB Finishing sander
- D Schwingschleifer
- RUS Виброшлифмашина
- CZ Oscilační bruska
- RO Polizor oscilant
- H Vibrációs csiszológép
- E Lijadora de oscilación

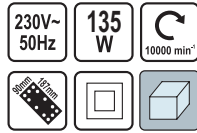

$L_{pA} = 84,0 \pm 3,0$  dB;  $L_{wA} = 95,0 \pm 3,0$  dB;  $a_n = 3,7 \pm 1,5$  m/s<sup>2</sup>

No.	W	min-1	
79491	135	10000	6

- PL Wyrzynarka
- GB Electric jig saw
- D Stichsäge
- RUS Лобзик электрический
- CZ Elektrická vyřezávací pila
- RO Fierastrau pendular
- H Elektromos dekopír fűrész
- E Cortadora electrica

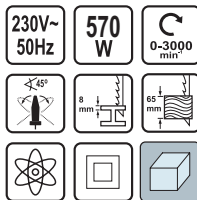

$L_{pA} = 90,0 \pm 3,0$  dB;  $L_{wA} = 101,0 \pm 3,0$  dB;  $a_n = 12,72 \pm 1,5 / 5,97 \pm 1,5$  m/s<sup>2</sup>

No.	W	min-1	
79482	570	0-3000	10

- PL Pilarka ręczna
- GB Circular saw
- D Handkreissäge
- RUS Пила циркулярная ручная
- CZ Pila kotoučová
- RO Fierastrau circular
- H Kézi körfűrészgép
- E Sierra de disco

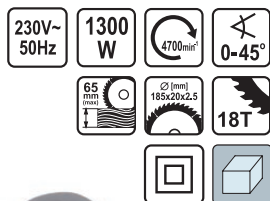

$L_{pA} = 86,0 \pm 3,0$  dB;  $L_{wA} = 97,0 \pm 3,0$  dB;  $a_n = 4,26 \pm 1,5$  m/s<sup>2</sup>

No.	W	min-1	
79249	1300	4700	4

- PL Wyrzynarka
- GB Electric jig saw
- D Stichsäge
- RUS Лобзик электрический
- CZ Elektrická vyřezávací pila
- RO Fierastrau pendular
- H Elektromos dekopír fűrész
- E Cortadora electrica

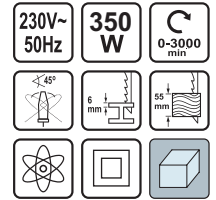

$L_{pA} = 90,0 \pm 3,0$  dB;  $L_{wA} = 101,0 \pm 3,0$  dB;  $a_n = 4,73 \pm 1,5 / 7,66 \pm 1,5$  m/s<sup>2</sup>

No.	W	min-1	
79332	350	0-3000	10

- PL Pilarka ręczna
- GB Circular saw
- D Handkreissäge
- RUS Пила циркулярная ручная
- CZ Pila kotoučová
- RO Fierastrau circular
- H Kézi körfűrészgép
- E Sierra de disco

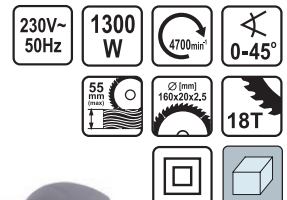

$L_{pA} = 86,0 \pm 3,0$  dB;  $L_{wA} = 97,0 \pm 3,0$  dB;  $a_n = 4,26 \pm 1,5$  m/s<sup>2</sup>

No.	W	min-1	
79248	1300	4700	4

- PL Opalarka
- GB Hot air gun
- D Heissluftpistole
- RUS Фен технический
- CZ Opalovací stroj
- RO Pistol aer cald
- H Hőlégfúvó tartozékokkalai
- E Secadora

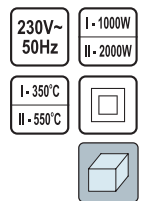

No.	W	°C	
79320	1000-2000	350-550	10

PL Opalarka  
GB Hot air gun  
D Heissluftpistole  
RUS Фен технический

CZ Opalovací stroj  
RO Pistol aer cald  
H Hőlégfúvó tartozékokkal  
E Secadora

230V~ 50Hz	I - 1000W II - 1500W
I - 300°C II - 500°C	



**STHOR**

No.	W	°C	
79327	1000-1500	300-500	10

PL Pistolet do klejenia  
GB Electric glue gun  
D Heissklebepistole  
RUS Пистолет для клея

CZ Pistolet na lepení  
RO Pistol pt. lipit  
H Ragasztópisztoly  
E Pistola de cola

230V~ 50Hz	15 g/min	180-200 °C	15(100) W
3-6 min	2x ∅11mm		



**STHOR**

No.	W	
73052	15 (100)	12/48

PL Odkurzacz przemysłowy  
GB Industrial vacuum cleaner  
D Industriesauger  
RUS Пылесос промышленный

CZ Průmyslový vysavač  
RO Aspirator industrial  
H Ipani porszívó  
E Aspirador industria

230V~ 50Hz	1600 W	30 l
16 kPa	IPX4	
POWER SOCKET GNIAZDO ZASILAJĄCE	WET AND DRY SUCHO MOKRO	
BLOW FUNCTION FUNKCJA DMUCHAWY		



**STHOR**

No.	W	
78873	1600	1

PL Opalarka z akcesoriami  
GB Hot air gun with accessories  
D Heissluftpistole  
RUS Фен технический в наборе

CZ Opalovací stroj w s příslušenstvím  
RO Fion cu accesorii pt. ars vopseaua  
H Hőlégfúvó tartozékokkal  
E Secadora con accesorios

230V~ 50Hz	I - 1000W II - 1500W
I - 300°C II - 500°C	



**STHOR**

No.	W	°C	
79328	1000-1500	300-500	5

PL Elektryczny pistolet natrykowy  
GB Electric spray gun  
D Elektro farbspritzpistole  
RUS Электрический пульверизатор

CZ Elektrická pistole malířská  
RO Pistol de vopsit - electric  
H Elektromos festékszoro pisztoly  
E Pistola de pintar electr.

230V~ 50Hz	60 W	0.24 l/min
800 ml	HVLP	



**STHOR**

$L_{pA} = 86,57 \pm 3,0$  dB;  $L_{wA} = 97,57 \pm 3,0$  dB;  $a_w = 10,46 \pm 1,5$  m/s<sup>2</sup>

No.	W	
79766	60	5

PL Lutownica oporowa  
GB Soldering iron  
D Delötkolben  
RUS Элктропаяльник

CZ Pájka odporová  
RO Ciocan de lipit  
H Huformasztópáka  
E Soldador de resistencia

230V~ 50Hz	400°C	5-10 min	
---------------	-------	-------------	--



**STHOR**

No.	W	
79365	30	25/50
79366	40	25/50
79367	60	25/50
79368	80	25/50

- PL Stacja lutownicza  
 GB Soldering station  
 D Lötstation  
 RUS Паяльная станция
- CZ Letovací stanice  
 RO Stație de lipit  
 H Forrasztópáka állomás  
 E Estación de soldadura

230V  
~50Hz

40  
W

150÷420  
°C

4.7 mm







No.	W	Icon
79376	40	

- PL Lutownica transformatorowa  
 GB Transformer soldering gun  
 D Lötpistole  
 RUS Паяльник электрический
- CZ Transformátorová páječka  
 RO Pistol de lipit + accesorii  
 H Forrasztópáka  
 E Soldador transformador

230V~  
50Hz

100  
W



No.	W	Icon
79354	100	

- PL Szlifierka stolowa  
 GB Bench grinder  
 D Doppelschleifmaschine  
 RUS Станок точильный
- CZ Stolní bruska  
 RO Polizor de banc  
 H Asztali kőszőrű  
 E Lijadera de mesa

230V~  
50Hz

150  
W

2950  
min<sup>-1</sup>

$L_{pA} = 63,0 \pm 3,0$  dB;  $L_{wA} = 76,0 \pm 3,0$  dB

No.	W	min-1	Icon
79206	150	2950	

- PL Komplet grotów do stacji lutowniczej  
 GB Spare soldering tips  
 D Lötspitze  
 RUS Наконечник паяльника
- CZ Hrot do letovačky  
 RO Vârf pt. ciocanul de lipit  
 H Pákahegy  
 E Pico soldador

3  
pcs



∅4.7 mm  
56.5 mm

40  
W

420  
°C

for/dla:  
79376





No.	W	pcs	R	for / dla	Icon
79377	40	3	0.4; 0.8; 1.2	79376	
79378	40	3	1.6; 1.6; 3.2	79376	

- PL Szlifierka stolowa  
 GB Bench grinder  
 D Doppelschleifmaschine  
 RUS Станок точильный
- CZ Stolní bruska  
 RO Polizor de banc  
 H Asztali kőszőrű  
 E Lijadera de mesa

230V~  
50Hz

120  
W

2950  
min<sup>-1</sup>

$L_{pA} = 63,0 \pm 3,0$  dB;  $L_{wA} = 76,0 \pm 3,0$  dB



No.	W	min-1	Icon
79205	120	2950	

- PL Szlifierka stolowa  
 GB Bench grinder  
 D Doppelschleifmaschine  
 RUS Станок точильный
- CZ Stolní bruska  
 RO Polizor de banc  
 H Asztali kőszőrű  
 E Lijadera de mesa

230V~  
50Hz

350  
W

2950  
min<sup>-1</sup>

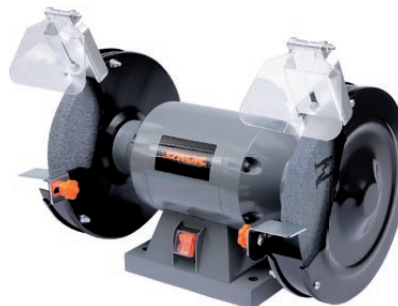
$L_{pA} = 63,0 \pm 3,0$  dB;  $L_{wA} = 76,0 \pm 3,0$  dB

No.	W	min-1	Icon
79207	350	2950	

- PL Zgrzewarka do rur termoplastycznych
- GB PVC plastic pipe welder
- D Schweissgerät für thermoplastische Rohre
- RUS Сварочная машина для термопластиковых труб
- CZ Svářečka na termoplastické trubky
- RO Hegesztő berendezés termoplasztikus csövekhez
- H Masina de sudat tevi termoplastice
- E Maquina de soldar las tubos termoplasticos

230V~ 50Hz	∅ [mm] 20, 25, 32 40, 50, 63
750 W	IPX0
1500 W	0-300 °C



No.	W	
78912	750-1500	4

Memo

- PL Wiertarka udarowa
- GB Impact drill
- D Schlagbohrmaschine
- RUS Дрель ударная
- CZ Nárazová vrtačka
- RO Masina de gaurit
- H Kezelési utasítás
- E Taladradora de percusión

230V~50Hz 500 W 13mm 0-3100 min<sup>-1</sup>



$L_{pa} = 88,0 \pm 3,0$  dB;  $L_{wa} = 99,0 \pm 3,0$  dB;  $a_h = 13,25 \pm 1,5 / 2,67 \pm 1,5$  m/s<sup>2</sup>

No.	W	min-1	
79024	500	0-3100	10

- PL Wiertarka udarowa
- GB Impact drill
- D Schlagbohrmaschine
- RUS Дрель ударная
- CZ Nárazová vrtačka
- RO Masina de gaurit
- H Kezelési utasítás
- E Taladradora de percusión

230V~50Hz 750 W 13mm 0-3000 min<sup>-1</sup>



$L_{pa} = 78,0 \pm 3,0$  dB;  $L_{wa} = 89,0 \pm 3,0$  dB;  $a_h = 2,93 \pm 1,5 / 8,43 \pm 1,5$  m/s<sup>2</sup>

No.	W	min-1	
79015	750	0-3000	10

- PL Wkrętarka akumulatorowa
- GB Cordless screwdriver
- D Akku-schrauber
- RUS Аккумуляторный шуруповерт
- CZ Utahovák akumulátorový
- RO Șurubelniță cu acumulator
- H Akkumulátoros csavarbehajtó
- E Herramienta de resistencia para soldar

3.6 V 800 mAh Li-Ion 250 min<sup>-1</sup> 2.0 Nm LED CHARGE INDICATOR LIGHT



$L_{pa} = 58,1 \pm 3,0$  dB;  $L_{wa} = 69,1 \pm 3,0$  dB;  $a_h = 0,409 \pm 1,5$  m/s<sup>2</sup>

No.	V	min-1	
79060	3.6	250	20

- PL Wiertarka udarowa
- GB Impact drill
- D Schlagbohrmaschine
- RUS Дрель ударная
- CZ Nárazová vrtačka
- RO Masina de gaurit
- H Kezelési utasítás
- E Taladradora de percusión

230V~50Hz 600 W 13mm 0-2800 min<sup>-1</sup>



$L_{pa} = 83,0 \pm 3,0$  dB;  $L_{wa} = 94,0 \pm 3,0$  dB;  $a_h = 2,89 \pm 1,5 / 9,08 \pm 1,5$  m/s<sup>2</sup>

No.	W	min-1	
79004	600	2800	6

- PL Młot udarowy
- GB Rotary hammer
- D Bohrhammer
- RUS Плещфоратор
- CZ Přeřezací kladivo
- RO Ciocan percutatnt
- H Fűrőkalapács-gép
- E Martillo de percusión

230V~50Hz 1050 W 900 min<sup>-1</sup> 4000 min<sup>-1</sup> 4.5J SDS+



$L_{pa} = 92,3 \pm 3,0$  dB;  $L_{wa} = 103,3 \pm 3,0$  dB;  $a_h = 12,730 \pm 1,5$  m/s<sup>2</sup>

No.	W	min-1	
79046	1050	900	2

- PL Szlifierka kątowa
- GB Angle grinder
- D Winkelschleifmaschine
- RUS Углошлифовальная машинка
- CZ Úhlová bruska
- RO Polizor unghiular
- H Sarokcsiszoló
- E Lijadera de angulo

230V~50Hz 900 W 10500 min<sup>-1</sup> 125 mm M14



$L_{pa} = 86,3 \pm 3,0$  dB;  $L_{wa} = 97,3 \pm 3,0$  dB;  $a_h = 8,673 \pm 1,5$  m/s<sup>2</sup>

No.	W	min-1	
79116	900	10500	6

- PL Szlifierka kątowa
- GB Angle grinder
- D Winkelschleifmaschine
- RUS Углошлифовальная машинка
- CZ Úhlová bruska
- RO Polizor unghiular
- H Sarokcsiszoló
- E Lijadera de angulo

230V~ 50Hz	2200 W	6300 min <sup>-1</sup>
230 mm	M14	



LUND

$L_{pA} = 96,0 \pm 3,0$  dB;  $L_{wA} = 107,0 \pm 3,0$  dB;  $a_h = 6,49 \pm 1,5$  m/s<sup>2</sup>

No.	W	min-1	
79150	2200	6300	4

- PL Szlifierka oscylacyjna
- GB Finishing sander
- D Schwingschleifer
- RUS Виброшлифовальная машина
- CZ Oscilační bruska
- RO Polizor oscilant
- H Vibrációs csiszológép
- E Lijadora de oscilación

230V~ 50Hz	135 W	11000 min <sup>-1</sup>
240 mm		



LUND

$L_{pA} = 79,7 \pm 3,0$  dB;  $L_{wA} = 90,7 \pm 3,0$  dB;  $a_h = 6,140 \pm 1,5 / 7,629 \pm 1,5$  m/s<sup>2</sup>

No.	W	min-1	
79493	135	11000	10

- PL Polerka samochodowa
- GB Car polisher
- D Autopoliermaschine
- RUS Полировальная машина
- CZ Leštička na automobily
- RO Maşina de lustruit automobile
- H Gépkocsi polirozógép
- E Máquina para pulir coches

230V~ 50Hz	1100 W	0-4000 min <sup>-1</sup>	180 mm
M14			



LUND

$L_{pA} = 68,0 \pm 3,0$  dB;  $L_{wA} = 79,0 \pm 3,0$  dB;  $a_h = 5,07 \pm 1,5$  m/s<sup>2</sup>

No.	W	min-1	
78945	1100	1500-4200	4

- PL Uniwersalna szlifierka wielofunkcyjna
- GB Mini grinder
- D Universal-Mehrzweckschleifmaschine
- RUS Универсальная шлифовальная машина
- CZ Všeúčelová univerzální bruska
- RO Maşina de şlefuit universală multifuncţională
- H Universalus daugiafunkcis šlifuoškis
- E Lijadora multifunción

230V~ 50Hz	135 W	40 pcs
10000-35000 min <sup>-1</sup>	2,3, 3,2 Ø mm	



LUND

$L_{pA} = 75,7 \pm 3,0$  dB;  $L_{wA} = 86,7 \pm 3,0$  dB;  $a_h = 2,397 \pm 1,5 / 1,739 \pm 1,5$  m/s<sup>2</sup>

No.	W	min-1	
79314	135	10000-35000	10

- PL Polerka samochodowa
- GB Car polisher
- D Autopoliermaschine
- RUS Полировальная машинка
- CZ Leštička na automobily
- RO Maşina de lustruit automobile
- H Gépkocsi polirozógép
- E Máquina para pulir coches

230V~ 50Hz	120 W	3200 min <sup>-1</sup>
240 mm		



LUND

$L_{pA} = 58,0 \pm 3,0$  dB;  $L_{wA} = 69,0 \pm 3,0$  dB;  $a_h = 14,8 \pm 1,5$  m/s<sup>2</sup>

No.	W	min-1	
82942	120	3200	6

- PL Wyrzynarka
- GB Electric jig saw
- D Stichsäge
- RUS Лобзик электрический
- CZ Elektrická vyřezávací pila
- RO Fierastrău pendular
- H Elektromos dekopír fűrész
- E Cortadora electrica

230V~ 50Hz	450 W	0-3000 min <sup>-1</sup>
45°	55 mm	8 mm



LUND

$L_{pA} = 84,0 \pm 3,0$  dB;  $L_{wA} = 95,0 \pm 3,0$  dB;  $a_h = 7,33 \pm 1,5 / 4,40 \pm 1,5$  m/s<sup>2</sup>

No.	W	min-1	
79479	450	0-3000	10



- PL Wyrzynarka
- GB Electric jig saw
- D Stichsäge
- RUS Лобзик электрический
- CZ Elektrická vyřezávací pila
- RO Fierastrau pendular
- H Elektromos dekopír fűrész
- E Cortadora electrica

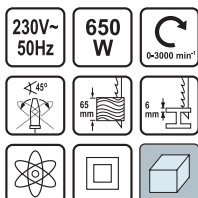

**LUND**

$L_{pa} = 90,0 \pm 3,0$  dB;  $L_{wa} = 101,0 \pm 3,0$  dB;  $a_n = 7,66 \pm 1,5 / 4,73 \pm 1,5$  m/s<sup>2</sup>

No.	W	min-1	
79481	650	0-3000	10

- PL Opalarka
- GB Hot air gun
- D Heissluftpistole
- RUS Фен технический
- CZ Opalovací stroj
- RO Pistol aer cald
- H Hőlégfúvó tartozékokkal
- E Secadora

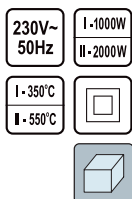

**LUND**

No.	W	°C	
79324	750-1500	300-500	10

- PL Opalarka z akcesoriami
- GB Hot air gun with accessories
- D Heissluftpistole
- RUS Фен технический в наборе
- CZ Opalovací stroj w s příslušenstvím
- RO Fion cu accesorii pt. ars vopseaua
- H Hőlégfúvó tartozékokkal
- E Secadora con accesorios

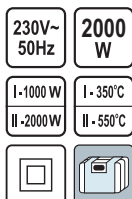

**LUND**

No.	W	°C	
79318	1000-2000	350-550	10

- PL Pilarka ręczna
- GB Circular saw
- D Handkreissäge
- RUS Пила циркулярная ручная
- CZ Pila kotoučová
- RO Fierastrau circular
- H Kézi körfűrészgép
- E Sierra de disco

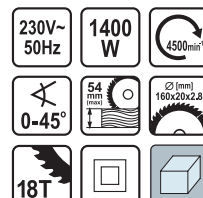

**LUND**

$L_{pa} = 101,8 \pm 3,0$  dB;  $L_{wa} = 112,8 \pm 3,0$  dB;  $a_n = 3,981 \pm 1,5 / 4,492 \pm 1,5$  m/s<sup>2</sup>

No.	W	min-1	
79334	1400	4500	4

- PL Opalarka z akcesoriami
- GB Hot air gun with accessories
- D Heissluftpistole
- RUS Фен технический в наборе
- CZ Opalovací stroj w s příslušenstvím
- RO Fion cu accesorii pt. ars vopseaua
- H Hőlégfúvó tartozékokkal
- E Secadora con accesorios

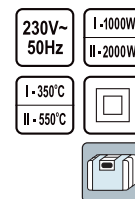

**LUND**

No.	W	°C	
79325	1000-2000	350-550	10

- PL Pistolet do klejenia
- GB Electric glue gun
- D Heissklebepistole
- RUS Пистолет для клея
- CZ Pistole na lepení
- RO Pistol pt. lipit
- H Ragasztópisztoly
- E Pistola de cola



**LUND**

No.	W	
73040	8 (30)	12/48

PL Pistolet do klejenia  
GB Electric glue gun  
D Heissklebepistole  
RUS Пистолет для клея

CZ Pistole na lepení  
RO Pistol pt. lipit  
H Ragasztópisztoly  
E Pistola de cola

230V~ 50Hz	7 g/min	190-210 °C	12(72) W
3-5 min	2x ∅11mm		



LUND

No.	W	
73051	12 (72)	12/48

PL Stacja lutownicza  
GB Soldering station  
D Lötstation  
RUS Паяльная станция

CZ Letovací stanice  
RO Stație de lipit  
H Forrasztópáka állomás  
E Estación de soldadura

230V~ 50Hz	40 W	150 ± 420 °C
2x ∅3.8mm		



LUND

No.	W	
79373	40	20

PL Lutownica transformatorowa  
GB Transformer soldering gun  
D Lötstation  
RUS Паяльник электрический

CZ Transformátorová páječka  
RO Pistol de lipit + accesorii  
H Forrasztópáka  
E Soldador transformador

230V~ 50Hz	100 W			
---------------	-------	--	--	--



LUND

No.	W	
79355	100	10

PL Pistolet do klejenia  
GB Electric glue gun  
D Heissklebepistole  
RUS Пистолет для клея

CZ Pistole na lepení  
RO Pistol pt. lipit  
H Ragasztópisztoly  
E Pistola de cola

230V~ 50Hz	11 g/min	200 °C	16 W
3-5 min	∅11 mm		



LUND

No.	W	
73060	16	10

PL Komplet grotów do stacji lutowniczej  
GB Spare soldering tips  
D Lötspitze  
RUS Наконечник паяльника

CZ Hrot do letovačky  
RO Vârf pt. ciocanul de lipit  
H Pákahegy  
E Pico soldador

2 pcs	R1.0 mm 4.2 mm	∅3.8 mm 25.5 mm	for/dla: 79373
40 W	420 °C		



LUND

No.	W	pcs	for / dla	
79374	40	2	79373	1000

PL Zgrzewarka do rur termoplastycznych  
GB PVC plastic pipe welder  
D Schweissgerät für thermoplastische Rohre  
RUS Сварочная машина для термопластиковых труб  
CZ Svářečka na termoplastické trubky  
RO Hegesztő berendezés termoplasztikus csövekhez  
H Masina de sudat tevi termoplastice  
E Maquina de soldar las tubos termoplasticos

230V~ 50Hz	800 W	0-300 °C	IPX4
∅ 16, 20, 25 [mm] 32, 40, 50			



LUND

No.	W	
78911	800	5

- PL** Akumulatorowe nożyce do trawy i krzewów  
**GB** Cordless grass and shrub shears  
**D** Akkuscherer mit Gras- und Strauchmesser  
**RUS** Аккумуляторные ножницы для травы и кустов  
**CZ** Akumulátorové nůžky na trávu a keře  
**RO** Trimmer cu acumulator pt. iarba si gard viu  
**H** Foarfecele cu acumulator pt. tăiat iarba  
**E** Tijeras a batería para hierba y arbustos

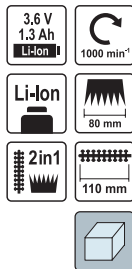
 $L_{pa} = 74,6 \pm 3,0 \text{ dB}; L_{wa} = 86,4 \pm 3,0 \text{ dB}; a_n = 1,63 \pm 1,5 \text{ m/s}^2$ 

No.	min-1	
79500	1000	8

- PL** Pompa zatapialna do wody brudnej  
**GB** Dirty water submersible pump  
**D** Tauchmotorpumpe  
**RUS** Погружной насос  
**CZ** Zátavnovací čerpadlo  
**RO** Pompă pt. apă murdară  
**H** Búvárszivattyú  
**E** Bomba de inmersión para agua sucia

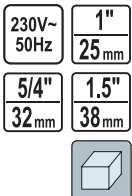

No.	W	l / h	H (max)	
79890	400	7500	5	4
79891	550	10500	7	4
79892	750	13000	9	2
79893	900	14000	10	2
79894	1100	15000	11	2

- PL** Pompa zatapialna do wody brudnej i ścieków  
**GB** Submersible pump for dirty water and wastewater  
**D** Tauchpumpe für Schmutzwasser  
**RUS** Погружной насос для грязной воды  
**CZ** Ponořené čerpadlo pro odpadní vody  
**RO** Pompă submersibilă pt. apă uzată  
**H** Búvárszivattyú szennyvíz  
**E** Bomba sumergible para aguas residuales



No.	W	l / h	H (max)	
79880	450	16000	9	1

- PL** Akumulatorowe nożyce do trawy i krzewów  
**GB** Cordless grass and shrub shears  
**D** Akkuscherer mit Gras- und Strauchmesser  
**RUS** Аккумуляторные ножницы для травы и кустов  
**CZ** Akumulátorové nůžky na trávu a keře  
**RO** Trimmer cu acumulator pt. iarba si gard viu  
**H** Foarfecele cu acumulator pt. tăiat iarba  
**E** Tijeras a batería para hierba y arbustos

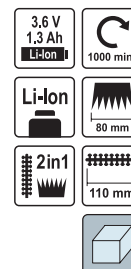
 $L_{pa} = 74,6 \pm 3,0 \text{ dB}; L_{wa} = 86,4 \pm 3,0 \text{ dB}; a_n = 1,63 \pm 1,5 \text{ m/s}^2$ 

No.	min-1	
79501	1000	8

- PL** Pompa zatapialna do wody brudnej  
**GB** Dirty water submersible pump  
**D** Tauchmotorpumpe  
**RUS** Погружной насос  
**CZ** Zátavnovací čerpadlo  
**RO** Pompă pt. apă murdară  
**H** Búvárszivattyú  
**E** Bomba de inmersión para agua sucia

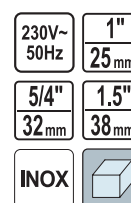

No.	W	l / h	H (max)	
79896	550	12500	8	2
79898	900	14500	10	2
79899	1100	15500	11	2

- PL** Pompa ogrodowa  
**GB** Jet pump  
**D** Gartenpumpe  
**RUS** Насос садовый  
**CZ** Zahradní čerpadlo  
**RO** Pompa apa  
**D** Gartenpumpe  
**H** Kerti szivattyúhoz  
**E** Bomba de jardín con cabeza

 $L_{wa} = 85,0 \text{ dB}$ 

No.	W	l / h	H (max)	max. pressure / max. ciśnienie (bar)	
79912	600	2800	35	3.5	1
79913	800	3200	40	4.0	1
79914	1000	3500	44	4.4	1

- PL Pompa fontanna
- GB Fountain pump
- D Springbrunnenpumpe
- RUS Фонтанный насос
- CZ Fontánová pumpa
- RO Pompa pt. fantana arteziana
- H Pumpa szökőkúthoz
- E Bomba para las fuentes

230V~  
50Hz

3  
NOZZLES  
DYSZE

IPX8



No.	W	l / h	H (max)	
79926	8	600	1.0	12
79927	16	800	1.3	12
79928	22	1000	1.6	12

- PL Pompa fontanna
- GB Fountain pump
- D Springbrunnenpumpe
- RUS Фонтанный насос
- CZ Fontánová pumpa
- RO Pompa pt. fantana arteziana
- H Pumpa szökőkúthoz
- E Bomba para las fuentes

230V~  
50Hz

CABLE  
10m

IP68

5  
NOZZLES



No.	W	l / h	H (max)	
79931	55	2000	2.5	8
79932	85	3000	3.5	8
79933	100	4500	4.5	6

- PL Pompa fontanna
- GB Fountain pump
- D Springbrunnenpumpe
- RUS Фонтанный насос
- CZ Fontánová pumpa
- RO Pompa pt. fantana arteziana
- H Pumpa szökőkúthoz
- E Bomba para las fuentes

230V~  
50Hz

5  
NOZZLES  
DYSZE

IPX8



No.	W	l / h	H (max)	
79929	28	1400	2.0	8
79930	40	1800	2.5	8

- PL Podkaszarka elektryczna
- GB Electric grass trimmer
- D Elektrische Untergrasmämaschine
- RUS Триммер электрический
- CZ Elektrická sekáčka na trávu
- RO Cositoare pt. iarba
- H Elektromos fűnyíró
- E Segadora

230V~  
50Hz

250  
W

14000  
min<sup>-1</sup>

200mm



$L_{pa} = 82,3 \pm 3,0$  dB;  $L_{wa} = 91,8 \pm 2,29$  dB;  $a_b = 4,549 \pm 1,5$  m/s<sup>2</sup>

No.	W	min-1	Ø (mm)	
79456	250	14000	200	6/12

- PL** Podkaszarka elektryczna  
**GB** Electric trimmer  
**D** Elektro-Rasentrimmer  
**RUS** Электрический триммер  
**CZ** Elektrická sekačka  
**RO** Cositoare electrică  
**H** Elektromos fűnyíró  
**E** Segadora eléctrica

 $L_{pa} = 83,2 \pm 3,0 \text{ dB}; L_{wa} = 94,1 \pm 1,94 \text{ dB}; a_n = 0,794 \pm 1,5 \text{ m/s}^2$ 

No.	W	min-1	Ø (mm)	
79467	500	10500	280	4

- PL** Nożyce do żywoplotu  
**GB** Hedge shears  
**D** Heckenscheren  
**RUS** Ножницы для живой изгороди  
**CZ** Nůžky na živý plot  
**RO** Foarfece pt. gard viu  
**H** Sövényvágó olló  
**E** Tijera para vallado

 $L_{pa} = 81,2 \pm 1,8 \text{ dB}; L_{wa} = 101,2 \pm 1,8 \text{ dB}; a_n = 2,840 \pm 1,5 \text{ m/s}^2$ 

No.	W	min-1	L (mm)	
79444	520	1600	510	4

- PL** Elektryczne nożyce do żywoplotu  
**GB** Hedge shears  
**D** Heckenscheren  
**RUS** Ножницы для живой изгороди  
**CZ** Nůžky na živý plot  
**RO** Foarfece pt. gard viu  
**H** Sövényvágó olló  
**E** Tijera para vallado

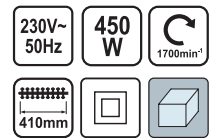
 $L_{pa} = 81,6 \pm 3,0 \text{ dB}; L_{wa} = 101,6 \pm 3,0 \text{ dB}; a_n = 5,328 \pm 1,5 / 6,1214 \pm 1,5 \text{ m/s}^2$ 

No.	W	min-1	L (mm)	
79442	450	1700	410	4

- PL** Nożyce do żywoplotu  
**GB** Hedge shears  
**D** Heckenscheren  
**RUS** Ножницы для живой изгороди  
**CZ** Nůžky na živý plot  
**RO** Foarfece pt. gard viu  
**H** Sövényvágó olló  
**E** Tijera para vallado

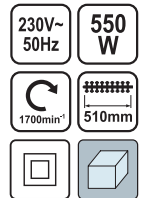
 $L_{pa} = 78,58 \pm 1,489 \text{ dB}; L_{wa} = 98,54 \pm 1,489 \text{ dB}; a_n = 3,272 \pm 1,5 / 3,435 \pm 1,5 \text{ m/s}^2$ 

No.	W	min-1	L (mm)	
79448	550	1700	510	4

PL Odkurzacz przemysłowy  
 GB Industrial vacuum cleaner  
 D Industriesauger  
 RUS Пылесос промышленный

CZ Průmyslový vysavač  
 RO Aspirator industrial  
 H Ipari porszívó  
 E Aspirador industria

230V~50Hz  
 1000 W  
 20l  
 17 kPa  
 IP24  
 BLOW FUNCTION  
 FUNKCJA DMUCHAWY  
 WET AND DRY  
 SUCHO MOKRO



No.	W	
78871	1000	1

PL Lutownica transformatorowa  
 GB Transformer soldering gun  
 D Lötspistole  
 RUS Паяльник электрический

CZ Transformátorová páječka  
 RO Pistol de lipit  
 H Forrasztópáka  
 E Soldador transformador

230V~50Hz  
 100 W  
 Light bulb icon  
 Square icon  
 Cube icon



No.	W	
79350	100	24

PL Przecinarka do glazury  
 GB Tile cutting machine  
 D Fliesenschneidmaschine  
 RUS Плиткорез электрический

CZ Stolní řezačka na kachličky  
 RO Aparat electric pt. taiat faianta  
 H Kezelési utasítási  
 E Cortadora de gres

230V~50Hz  
 600W  
 2950min<sup>-1</sup>  
 35 mm (max)  
 22mm  
 180mm  
 2.2mm  
 300mm  
 0-45°  
 Square icon  
 Cube icon



L<sub>PA</sub> = 92,0 ± 3,0 dB; L<sub>WA</sub> = 105,0 ± 3,0 dB

No.	W	min-1	Ø (mm)	
79261	600	2950	180	1

PL Lutownica pistoletowa  
 GB Soldering iron  
 D Delötkolben  
 RUS Электропаяльник

CZ Pájka odporová  
 RO Ciocan de lipit  
 H Huforrasztópáka  
 E Soldador de resistencia

230V~50Hz  
 40 W  
 420°C  
 3.8 mm  
 70 mm  
 Square icon  
 Cube icon



No.	W	
79358	40	25/50

PL Lutownica transformatorowa  
 GB Transformer soldering gun  
 D Lötspistole  
 RUS Паяльник электрический

CZ Transformátorová páječka  
 RO Pistol de lipit  
 H Forrasztópáka  
 E Soldador transformador

230V~50Hz  
 100 W  
 Light bulb icon  
 Square icon  
 Cube icon



No.	W	
79351	100	10

PL Głowica żyłkowa  
GB Line head  
D Trimmerkopf  
RUS Головка с леской  
CZ Strunová hlava  
RO Cap cu cablu  
H Damil fej  
E Cabezal de hilo



No.	Ø (mm)	Box
79550	2.0-2.4	10/40

PL Głowica żyłkowa  
GB Line head  
D Trimmerkopf  
RUS Головка с леской  
CZ Strunová hlava  
RO Cap cu cablu  
H Damil fej  
E Cabezal de hilo



No.	Ø (mm)	Box
79552	2.4-2.7	10/40

PL Żyłka tnąca  
GB Grass trimmer line  
D Mähfaden  
RUS Леска для триммера  
CZ Struna do strunové sekačky  
RO Furtun gradina  
H Damil szegélynyíró géphez  
E Hilo de cortar



No.	Ø (mm)	L (m)	profil	Box
89401	1.3	10	o	20/240
89402	1.6	10	o	20/240
89403	2.0	10	o	20/240
89404	2.4	10	o	12/144
89405	2.6	10	o	12/144
89406	3.0	10	o	12/144

PL Żyłka tnąca  
GB Grass trimmer line  
D Mähfaden  
RUS Леска для триммера  
CZ Struna do strunové sekačky  
RO Furtun gradina  
H Damil szegélynyíró géphez  
E Hilo de cortar



No.	Ø (mm)	L (m)	profil	Box
89411	1.3	10	□	20/240
89412	1.6	10	□	20/240
89413	2.0	10	□	20/240
89414	2.4	10	□	12/144
89415	2.6	10	□	12/144
89416	3.0	10	□	12/144

PL Głowica żyłkowa  
GB Line head  
D Trimmerkopf  
RUS Головка с леской  
CZ Strunová hlava  
RO Cap cu cablu  
H Damil fej  
E Cabezal de hilo

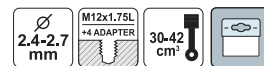

No.	Ø (mm)	Box
79551	2.4-2.7	10/40

PL Głowica żyłkowa  
GB Line head  
D Trimmerkopf  
RUS Головка с леской  
CZ Strunová hlava  
RO Cap cu cablu  
H Damil fej  
E Cabezal de hilo



No.	Ø (mm)	for / dla	Box
79468	1.2	79467	20/100

PL Żyłka tnąca  
GB Grass trimmer line  
D Mähfaden  
RUS Леска для триммера  
CZ Struna do strunové sekačky  
RO Furtun gradina  
H Damil szegélynyíró géphez  
E Hilo de cortar



No.	Ø (mm)	L (m)	profil	Box
89441	2.0	120	o	27
89442	2.4	90	o	27
89443	2.6	70	o	27
89444	3.0	56	o	27
89445	3.3	45	o	27

PL Żyłka tnąca  
GB Grass trimmer line  
D Mähfaden  
RUS Леска для триммера  
CZ Struna do strunové sekačky  
RO Furtun gradina  
H Damil szegélynyíró géphez  
E Hilo de cortar



No.	Ø (mm)	L (m)	profil	Box
89452	2.4	90	□	16
89453	2.6	70	□	16
89454	3.0	56	□	16

- PL Żyłka tnąca
- GB Grass trimmer line
- D Mähfaden
- RUS Леска для триммера
- CZ Struna do stminové sekačky
- RO Furtun gradina
- H Damil szegélynyíró géphez
- E Hilo de cortar



**FLO**

No.	Ø (mm)	L (m)	profil	
89421	1.3	15	☆	24/288
89422	1.6	15	☆	20/240
89423	2.0	15	☆	16/192
89424	2.4	15	☆	12/144
89425	2.6	15	☆	12/144
89426	3.0	15	☆	10/120

- PL Żyłka tnąca
- GB Grass trimmer line
- D Mähfaden
- RUS Леска для триммера
- CZ Struna do stminové sekačky
- RO Furtun gradina
- H Damil szegélynyíró géphez
- E Hilo de cortar



**FLO**

EXTRANYL

No.	Ø (mm)	L (m)	profil	
89462	2.4	15		10/120
89463	2.7	15		10/120
89464	3.0	12		10/120

- PL Żyłka tnąca
- GB Grass trimmer line
- D Mähfaden
- RUS Леска для триммера
- CZ Struna do stminové sekačky
- RO Furtun gradina
- H Damil szegélynyíró géphez
- E Hilo de cortar



**FLO**

TRYGON

No.	Ø (mm)	L (m)	profil	
89470	2.4	15		10/120
89471	2.7	15		10/120
89472	3.0	12		10/120

- PL Żyłka tnąca
- GB Grass trimmer line
- D Mähfaden
- RUS Леска для триммера
- CZ Struna do stminové sekačky
- RO Furtun gradina
- H Damil szegélynyíró géphez
- E Hilo de cortar



**FLO**

SILENT

No.	Ø (mm)	L (m)	profil	
89478	1.6	15		20/240
89479	2.0	15		20/240
89480	2.4	15		10/120
89481	2.7	15		10/120
89482	3.0	12		10/120

- PL Żyłka tnąca
- GB Grass trimmer line
- D Mähfaden
- RUS Леска для триммера
- CZ Struna do stminové sekačky
- RO Furtun gradina
- H Damil szegélynyíró géphez
- E Hilo de cortar



**FLO**

No.	Ø (mm)	L (m)	profil	
89456	2.0	90	☆	9/27
89457	2.4	90	☆	9/27
89458	2.6	90	☆	9/27
89459	3.0	60	☆	9/27

- PL Żyłka tnąca
- GB Grass trimmer line
- D Mähfaden
- RUS Леска для триммера
- CZ Struna do stminové sekačky
- RO Furtun gradina
- H Damil szegélynyíró géphez
- E Hilo de cortar



**FLO**

EXTRANYL

No.	Ø (mm)	L (m)	profil	
89465	2.4	90		10/20
89466	2.7	70		10/20
89467	3.0	60		10/20

- PL Żyłka tnąca
- GB Grass trimmer line
- D Mähfaden
- RUS Леска для триммера
- CZ Struna do stminové sekačky
- RO Furtun gradina
- H Damil szegélynyíró géphez
- E Hilo de cortar



**FLO**

TRYGON

No.	Ø (mm)	L (m)	profil	
89473	2.4	90		10/20
89474	2.7	70		10/20
89475	3.0	60		10/20

- PL Żyłka tnąca
- GB Grass trimmer line
- D Mähfaden
- RUS Леска для триммера
- CZ Struna do stminové sekačky
- RO Furtun gradina
- H Damil szegélynyíró géphez
- E Hilo de cortar



**FLO**

SILENT

No.	Ø (mm)	L (m)	profil	
89483	2.0	90		10/20
89484	2.4	90		10/20
89485	2.7	70		10/20
89486	3.0	60		10/20



- PL Przyłącze do węzła do pomp zasilanych  
 GB Hose connection  
 D Druckleitung-Anschlussstütze  
 RUS Соединитель для шланга  
 CZ Koleno k hadici  
 RO Ștuț de fixare furtun  
 H Tömlő csatlakozó  
 E Tubuladura para manguera para bombas de inmersiyn

G 1.5" for: dla:  
 79903 79907  
 79904 79921  
 79905 79923  
 79906

G 38mm



No.		
79919		100

- PL Glowica do wiertarki samozaciskowej  
 GB Drill chuck  
 D Schnellspanbohrfutter  
 RUS Патрон для дрели быстрозажимной
- CZ Hlava na vrtáčku samosvorná  
 RO Mandrină cu autostrângere pt. bormașină  
 H Az önbeszorulós fűrőgéptokmányfej  
 E Cabeza para taladradora autoapriete



No.	Ø (mm)	size / rozmiar	
79570	1-10	3/8" (10.0 mm)	10/50
79572	1-10	1/2" (12.5 mm)	10/50

- PL Glowica do wiertarki na klucz  
 GB Drill chuck  
 D Schnellspanbohrfutter  
 RUS Патрон для дрели зубчатый
- CZ Hlava na vrtáčku na klíč  
 RO Mandrină cu cheie pt. bormașină  
 H Az önbeszorulós fűrőgéptokmányfej  
 E Cabeza para taladradora de llave



No.	Ø (mm)	size / rozmiar	
79600	1.5-10	3/8" (10.0 mm)	10/50
79620	1.5-10	1/2" (12.5 mm)	10/50
79630	1.5-13	1/2" (12.5 mm)	5/40

- PL Wielofunkcyjna ostrzałka do wiertel  
 GB Multipurpose drill bit sharpener  
 D Vielzweck Bohrerschleifgerät  
 RUS Машина для заточки сверл
- CZ Ostrůvka pro ostření vrtáků  
 RO Masina de ascuțit burghie  
 H Fűrőléző  
 E Afiladora de brocas



TWO ABRASIVE DISCS  
 DWIE TARCZE ŚCIERNE

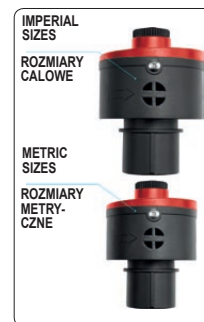

230V~50Hz 70 W 230V~50Hz  
 1600min<sup>-1</sup> 3-16mm

No.	w	
73470	70	6

- PL Komplet tarcz do pilarki dwutarczowej  
 GB Set of discs for double-disc sawing machines  
 D Sägeblattsatz für eine Zweischeibensäge  
 RUS Комплект дисков для двухдисковой пилы  
 CZ Sada kotoučů pro dvoukotoučovou pilu  
 RO Set de discuri pt. ferăstrău cu două discuri  
 H Tárcakészlet két tárcsás fűrészhez  
 E Juego de discos para máquina de serrar de dos discos

2 PCS 32T 125x16x1.6 125x28x1.6  
 for/dla: 79255

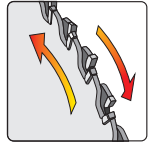

No.	Ø (mm)	for / dla	pcs	
79256	125x16x1.6; 125x28x1.6	79255	2	50

- PL Glowica do wiertarki samozaciskowej  
 GB Drill chuck  
 D Schnellspanbohrfutter  
 RUS Патрон для дрели быстрозажимной
- CZ Hlava na vrtáčku samosvorná  
 RO Mandrină cu autostrângere pt. bormașină  
 H Az önbeszorulós fűrőgéptokmányfej  
 E Cabeza para taladradora autoapriete

2-13 mm

1/2" (12.5 mm) - 20 UNF



No.	Ø (mm)	size / rozmiar	
79580	2-13	1/2" (12.5 mm)	5/40

- PL Adapter SDS-plus - UNF 1/2"  
 GB Adapter SDS-plus - UNF 1/2"  
 D Adapter SDS-plus - UNF 1/2"  
 RUS Переходник с SDS плюс на 1/2 дюйма  
 CZ Přenoska SDS-plus - UNF 1/2"  
 RO Adaptor SDS-plus - UNF 1/2"  
 H SDS-plus adapter - UNF 1/2"  
 E Adaptor SDS-plus - UNF 1/2"

1/2" (12.5 mm) - 20 UNF

SDS+



No.	size / rozmiar	
79800	1/2" (12.5 mm)	12/144

- PL Ostrzałka wielofunkcyjna  
 GB Multi-function sharpener  
 D Multifunktionales schärfgerät  
 RUS Многофункциональный заточной станок  
 CZ Všeúčelová bruska  
 RO Mașină de ascuțit multifuncțională  
 H Multifunkciós élezőgép  
 E Afilador multifuncional

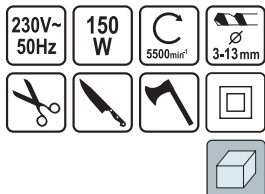

**STHOR**

$L_{pA} = 81,56 \pm 3,0$  dB;  $L_{wA} = 94,56 \pm 3,0$  dB

No.	W	
73473	150	2

- PL Stojak do wiertarki  
 GB Drill stand  
 D Bohrmaschinenständer  
 RUS Сверлильная станция  
 CZ Stativ do vrtačky  
 RO Suport masina de gaurit  
 H Fűrőállvány  
 E Soporte para taladro

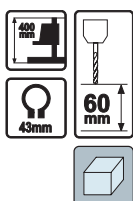

**VOREL**

No.	h (mm)	
79640	400	10

- PL Tamiki trzpieniowe  
 GB Rotary file set  
 D Raspelaufsatz  
 RUS Набор металлических бор-фрез
- CZ Hrotové rašple  
 RO Set raspile cu tija  
 H Fareszelőkészlet, csapszárú  
 E Escofinas



No.	Ø (mm)	pcs	
25450	6	5	25/200

- PL Statyw do szlifierek kątowych  
 GB Angle grinder stand  
 D Winkelschleif-Trennständer  
 RUS Штатив
- CZ Stojan pro úhlovou brusku  
 RO Stativ pt. polizor unghiular  
 H Állvány sarokcsiszolóhoz  
 E Soporte para lijadora de ángulo



**VOREL**

No.	
79641	4

- PL Zapasowe ostrza do struga elektrycznego  
 GB Spare cutting knife for electric planner  
 D Hobelmesser für Elektrohobel  
 RUS Лезвия для электрорубанка  
 CZ Náhradní nůž pro elektr. hoblíku  
 RO Lamă de rezervă pt. rindea electrică  
 H Tartalék gyalukés elektromos gyalugéphez  
 E Filos de repuesto para capillo eléctrico



**STHOR**

No.	pcs packing	
79346	2	30/360

- PL Kamienie szlifierskie trzpieniowe  
 GB Mounted stone set  
 D Schleifsteinaufsätze  
 RUS Набор абразивных наконечников
- CZ Brusné kameny hrotové  
 RO Set pietre abrazive cu tija  
 H Csiszolókészlet, csapszárú  
 E Discos de esmeril

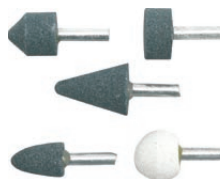
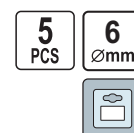

No.	Ø (mm)	pcs	
25400	6	5	25/200

- PL Zestaw końcówek do szlifierek  
 GB Mini grinder accessories set  
 D Schleifaufsätze  
 RUS Набор шлифовальных и полировочных насадок для арт.79316
- CZ Soustava koncovek na brusku  
 RO Set pietre abrazive si pasla pt. slefuit  
 H Fejkészlet csiszológéphez  
 E Juego de puntas de pulir



**VOREL**

No.	pcs	
25410	13	10/50

- PL Zestaw końcówek do szlifierki  
 GB Mini grinder accessories set  
 D Schleifaufsätze  
 RUS Набор шлифовальных и полировочных насадок для арт.79316
- CZ Soustava koncovek na brusku  
 RO Set pietre abrazive si pasla pt. slefuit  
 H Fejkészlet csiszológéphez  
 E Juego de puntas de pulir

17  
PCS





**VOREL**

No.	pcs	
25411	17	10/50

- PL Nakładki polerujące  
 GB Polishing covers  
 D Polierscheibe  
 RUS Полировочные накладки
- CZ Leštící kotouč  
 RO Polizor captusit  
 H Polírozó korong  
 E Fundas

2  
PCS

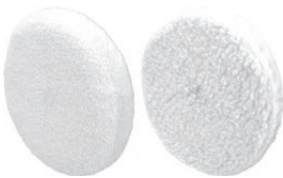
Ø [mm]  
245

**VOREL**

No.	Ø (mm)	for / dla	pcs packing	
82941	245	82940	2	10/100

- PL Wkłady klejowe  
 GB Glue sticks  
 D Heissklebpatronen  
 RUS Тубы для клеящего пистолета
- CZ Lepící vložky  
 RO Articole plastic (pt. pistol lipit)  
 H Ragasztóbetét  
 E Cartucho de cola



**STHOR**

No.	mm	pcs	
73260	7x100	12	50/200
73270	11x100	6	20/120
73271	11x150	12	20/60

- PL Stojak do lutownicy  
 GB Soldering iron stand  
 D LötKolbenständer  
 RUS Подставка для паяльника
- CZ Stojan na pájku  
 RO Suport pt. ciocan lipit  
 H Forrasztópáka tartó  
 E Caballete de soldador



**VOREL**

No.		
79386		50

- PL Zestaw końcówek do szlifierki  
 GB Mini grinder accessories set  
 D Schleifaufsätze  
 RUS Набор шлифовальных и полировочных насадок для арт.79316
- CZ Soustava koncovek na brusku  
 RO Set pietre abrazive si pasla pt. slefuit  
 H Fejkészlet csiszológéphez  
 E Juego de puntas de pulir

22  
PCS



**VOREL**

No.	pcs packing	
25412	22	10/50

- PL Wkłady klejowe  
 GB Glue sticks  
 D Heissklebpatronen  
 RUS Тубы для клеящего пистолета
- CZ Lepící vložky  
 RO Articole plastic (pt. pistol lipit)  
 H Ragasztóbetét  
 E Cartucho de cola



**VOREL**

No.	mm	kg	
73300	11x200	1	10

- PL Zestaw „trzecia ręka”  
 GB Helping hand with magnifying glass  
 D Hilfhand mit Lupe  
 RUS Комплект „третья рука” с лупой  
 CZ Sada „třetí ruka”  
 RO Ceva cu lupa  
 H Paneltartó állvány „harmadik kéz”  
 E Juego „la tercera mano” con lupa



No.	glass / szkło Ø (mm)	
73500	62	10/40

- PL Spoiwo lutownicze  
 GB Solder  
 D Lötzinn  
 RUS Припой
- CZ Pájka  
 RO Sarna de sudura  
 H Forrasztó ón  
 E Estaño plata

Sn60  
Pb40



**Cynel**  
unipress

>>>

No.	Ø (mm)	weight / waga (g)	
76800	0.5	100	60
76801	0.5	250	40
76806	0.7	100	60
76807	0.7	250	40
76810	1.0	100	60

- PL Spoiwo lutownicze  
GB Solder  
D Lötzin  
RUS Припой
- CZ Pájka  
RO Sama de sudura  
H Forrasztó ón  
E Estaño plata

Sn60  
Pb40



No.	Ø (mm)	weight / waga (g)	
76811	1.0	250	20
76814	1.5	100	60
76815	1.5	250	20
76818	2.0	100	60
76819	2.0	250	20
76820	2.0	500	20
76822	2.5	100	60
76823	2.5	250	40
76824	2.5	500	20
76826	3.0	100	60
76827	3.0	250	40
76828	3.0	500	20

- PL Pasta lutownicza  
GB Solder paste  
D Lotpaste  
RUS Паяльная паста
- CZ Pájeci pasty  
RO Pasta decapante sudura  
H Forrasztó paszta  
E Pasta de soldar

FLUX  
TOPNIK  
1.12 G  
PN EN 28454



No.	weight / waga (g)	
76835	40	50

- PL Kalafonia lutownicza  
GB Rosin  
D Kolophonium  
RUS Канифоль
- CZ Kalafuna  
RO Colofoniu  
H Forrasztó gyanta  
E Colofonia



No.	weight / waga (g)	
76836	45	50

- PL Zestaw narzędzi lutowniczych  
GB Soldering accessories  
D Lötzubehör  
RUS Принадлежности для пайки
- CZ Pájeci příslušenství  
RO Accesorii de lipit  
H Forrasztó tartozékok  
E Jooteseadmed tarvikud

6  
PCS

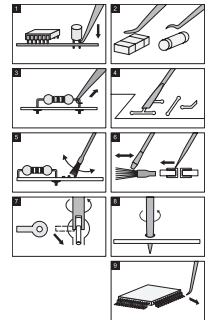

No.	pcs	
79398	6	25/100

- PL Spoiwo lutownicze  
GB Solder  
D Lötzin  
RUS Припой
- CZ Pájka  
RO Sama de sudura  
H Forrasztó ón  
E Estaño plata

Sn60  
Pb40



No.	Ø (mm)	weight / waga (g)	
76830	1.0	16	25/500

- PL Cyna w lasce  
GB Solder stick  
D Stangenlötzin  
RUS Припой
- CZ Pájka v tyčkách  
RO Baghete de sudura  
H Forrasztó rúd  
E Barra estaño plomo

Sn60  
Pb40



No.	dimensions / wymiary (mm)	weight / waga (kg)	
76832	7x7x322	5	1

- PL Odsysacz do cyny  
GB Desoldering pump  
D Entlötsaugpumpe  
RUS Шприц для удаления припоя
- CZ Odpájeci sací pumpa  
RO Pompa fluidor  
H Ónszipantó  
E Bomba desoldadora

PTFE  
TIP



No.	
79390	100/400

PL Odsyszac do cyny  
GB Desoldering pump  
D Entlötlötpumpe  
RUS Шприц для удаления припоя

CZ Odpájecí sací pumpa  
RO Pompa fluidor  
H Ónszippantó  
E Bomba desoldadora



No.	
79391	70/140

PL Wąż tłoczny do motopomp z końcówkami  
GB Pumping hose for motor pumps with terminals  
D Druckschlauch für Motorpumpen mit Anschlussstücken  
RUS Напорный рукав для мотопомп с наконечниками  
CZ Výtlačná hadice s koncovkami pro motorová čerpadla  
RO Furtun pt. motopompe cu capete  
H Szivattyú nyomótömlő kápcsokkal szerelve  
E Manguera para bombear para motobombas con terminales



No.	L (m)	Ø	max. working pressure / max. ciśnienie robocze (bar)	bursting pressure / ciśnienie rozrywające (bar)	
79977	20	2" (50 mm)	6	24	1
79978	20	3" (75 mm)	6	24	1
79979	20	4" (100 mm)	6	24	1

PL Nasada Storza z gwintem wewnętrznym  
GB Storz attachment with internal thread  
D Aufsatzarmatur mit Innengewinde wg Storz  
RUS Гайка Шторца с внутренней резьбой

CZ Adaptér Storz s vnitřním závitem  
RO Racord Storz cu filet interior  
H Csonkkapocs belső menetes  
E Boquilla Storz con rosca interna



No.	Ø	bursting pressure / ciśnienie rozrywające (bar)	
79990	2" (50 mm)	48	1
79991	3" (75 mm)	48	1
79992	4" (100 mm)	48	1

PL Wąż ssący z końcówkami  
GB Suction hose with terminals  
D Saugschlauch mit Anschlussstücken  
RUS Шланг всасывающий с наконечниками

CZ Sací hadice s koncovkami  
RO Furtun sucțiune cu capete  
H Szivattyú szívótömlő kápcsokkal szerelve  
E Manguera de succión con terminales



No.	L (m)	Ø	
80001	2.5	3" (75 mm)	1
80002	2.5	4" (100 mm)	1

PL Opaska antystatyczna  
GB Antistatic wrist strap  
D Antistatisches Armband  
RUS Браслет антистатический

CZ Pásek antistatický  
RO Cureau antistatică  
H Antisztatikus csuklópánt  
E Pulsera antiestática



No.	
79395	100

PL Wąż tłoczny do motopomp  
GB Pumping hose for motor pumps  
D Druckschlauch für Motorpumpen  
RUS Напорный рукав для мотопомп

CZ Výtlačná hadice pro motorová čerpadla  
RO Furtun pt. motopompe  
H Szivattyú nyomótömlő  
E Manguera para bombear para motobombas



No.	L (m)	Ø	max. working pressure / max. ciśnienie robocze (bar)	bursting pressure / ciśnienie rozrywające (bar)	
79982	50	1" (25 mm)	2	6	1
79983	50	2" (50 mm)	2	6	1
79984	50	3" (75 mm)	2	6	1

PL Łączniki Storza tłoczne  
GB Pumping Storz connectors  
D Druckverbinderarmatur wg Storz  
RUS Гайки Шторца напорные

CZ Spojka Storz výtlačná  
RO Racorduri Storz descărcare  
H Tömlőkapcsok, nyomó  
E Conectores Storz para bombeo



No.	Ø	bursting pressure / ciśnienie rozrywające (bar)	
79993	2" (50 mm)	48	1
79994	3" (75 mm)	48	2

PL Łączniki Storza ssawne  
GB Suction Storz connectors  
D Saugverbinderarmatur wg Storz  
RUS Гайки Шторца всасывающие

CZ Spojka Storz sací  
RO Racorduri Storz sucțiune  
H Tömlőkapcsok, szívó  
E Conectores Storz para succión



No.	Ø	bursting pressure / ciśnienie rozrywające (bar)	
79996	2" (50 mm)	48	1
79997	3" (75 mm)	48	1
79998	4" (100 mm)	48	2



# 16

## Welding equipment Sprzęt spawalniczy

**Welding accessories**  
**Akcesoria spawalnicze**

238-243

<b>Electrodes &amp; welding wires</b>	
Elektrody i druty do spawania.....	238
<b>Clamps</b>	
Zaciski spawalnicze.....	238
<b>Welding goggles &amp; masks</b>	
Okulary i maski spawalnicze.....	238
<b>Hammers</b>	
Młotki.....	241
<b>Lock grip pliers</b>	
Szczypcy zaciskowe.....	241
<b>Tin snips</b>	
Nożyce do blachy.....	242

PL Elektrody rutyłowe  
GB Welding electrodes  
D Rutilstabelektroden  
RUS Сварочный электрод

CZ Elektrody  
RO Electrozi pt. sudura  
H Elektrodák  
E Elektrodos



No.	Ø (mm)	L (mm)	kg	☐
74307	2.5	350	4	1
74311	3.2	450	5	1
74316	4.0	450	6	1

PL Zacisk spawalniczy  
biegunowo-kleszczowy  
GB Clamp  
D Schweisseklemme  
RUS Клепцы для сварки

CZ Kleště svářečské zemnicí  
RO Cleste pt. sudura  
H Testkábel-csatlakozó  
E Cocodrilo para soldar



No.	max welding current / max prąd spawania (A)	Ø earthing cable / Ø kabla masowego (mm <sup>2</sup> )	max range / max rozwarcie (mm)	weight / waga (kg)	type	☐
74420	160	35	50	0.21	ZBK-35	25
74421	315	70	60	0.25	ZBK-70	25
74422	520	95	70	0.29	ZBK-95	25

PL Okulary spawalnicze  
GB Welding goggles  
D Schweisserbrille  
RUS Очки газосварщика

CZ Brýle svářečské  
RO Ochelari pt. sudura  
H Hegesztőszemüveg  
E Gafas para soldar

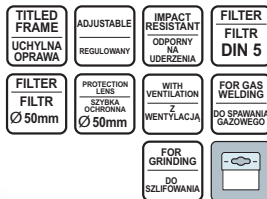

**VOREL**

No.	☐
74400	25/100

PL Okulary spawalnicze  
GB Welding goggles  
D Schweisserbrille  
RUS Очки газосварщика

CZ Brýle svářečské  
RO Ochelari pt. sudura  
H Hegesztőszemüveg  
E Gafas para soldar

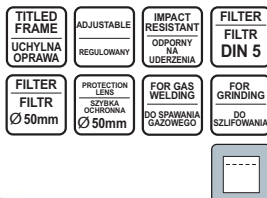

No.	☐
74411	10/100

PL Drut spawalniczy  
GB Welding wire  
D Fühldraht  
RUS Сварочная проволока стальная

CZ Drát svařovací  
RO Sarmă pt. sudura  
H Forrasztó ón  
E Alambre de soldado



No.	Ø (mm)	kg	☐
74255	0.8	5	1

PL Uchwyt spawalniczy elektrodowy  
GB Electrode holder  
D Schweisselectrodengriff  
RUS Клепцы для сварки (электродные)

CZ Držák elektrod  
RO Cleste pt. sudura cu electrod  
H Elektrodafogó  
E Abrazadera para soldar, de electrodos



No.	max welding current / max prąd spawania (A)	electrode diameter / średnica elektrod (mm)	Ø welding cable / Ø przewodu spawalniczego (mm <sup>2</sup> )	weight / waga (kg)	type	☐
74430	200A (X=60%) / 315A (X=35%)	35-50	2-5	0.32	UE-200	25
74431	315A (X=60%) / 400A (X=35%)	50-70	2.5-6.3	0.42	UE-300	25
74432	430A (X=60%) / 530A (X=35%)	70-95	3.5-6.3	0.50	UE-400	25

PL Okulary spawalnicze  
GB Welding goggles  
D Schweisserbrille  
RUS Очки газосварщика

CZ Brýle svářečské  
RO Ochelari pt. sudura  
H Hegesztőszemüveg  
E Gafas para soldar



No.	☐
74410	5/100

PL Maska spawalnicza  
GB Welding mask  
D Schweissermaske  
RUS Щиток сварщика  
CZ Svářečská maska  
RO Mască de sudură  
H Hegesztőpajzs  
E Mascara de soldador



No.	type	☐
74440	TSM-3	30



- PL Maska spawalnicza  
 GB Welding mask  
 D Schweissmaske  
 RUS Щиток сварщика  
 CZ Svářečská maska  
 RO Mască de sudură  
 H Hegesztőpajzs  
 E Mascara de soldador

FILTER SIZE ROZMIAR FILTRA 50x100 mm	222x372 x80 mm	FILTER FILTR DIN 10	WEIGHT WITHOUT LENS WAGA BEZ SZKIEŁ 366 g	
--	-------------------	---------------------------	---	--



No.	type	
74442	TSM	30

- PL Maska spawalnicza  
 GB Welding mask  
 D Schweissmaske  
 RUS Щиток сварщика  
 CZ Svářečská maska  
 RO Mască de sudură  
 H Hegesztőpajzs  
 E Mascara de soldador

FILTER SIZE ROZMIAR FILTRA 50x100 mm	257x450 x96 mm	WEIGHT WITHOUT LENS WAGA BEZ SZKIEŁ 455 g	
--	-------------------	---	--



No.	type	
74450	TSD-3	20

- PL Przyłbica spawalnicza z podglądem  
 GB Welding mask  
 D Schweissmaske  
 RUS Щиток сварщика с подсмотром  
 CZ Svářečská přilba s nakoukáváním  
 RO Mască de sudură cu geam  
 H Hegesztősisak kitékintővel  
 E Mascara de soldador con mirador

FILTER SIZE ROZMIAR FILTRA 50x100 mm DIN 8-13	SPECTACLE LENS SIZE SZKIEŁ ROZMIAR 20x100 mm (DIN 5)	225x290 x175 mm	
FILTER FILTR DIN 10	WEIGHT WITHOUT LENS WAGA BEZ SZKIEŁ 427 g		



No.	type	
74448	PS-3	10

- PL Maska spawalnicza  
 GB Welding mask  
 D Schweissmaske  
 RUS Щиток сварщика  
 CZ Svářečská maska  
 RO Mască de sudură  
 H Hegesztőpajzs  
 E Mascara de soldador

FILTER SIZE ROZMIAR FILTRA 50x100 mm	SPECTACLE LENS SIZE SZKIEŁ ROZMIAR 20x100 mm (DIN 5)	222x372 x80 mm	FILTER FILTR DIN 10	WEIGHT WITHOUT LENS WAGA BEZ SZKIEŁ 408 g	
--	---	-------------------	---------------------------	---	--



No.	type	
74443	TSM	20

- PL Przyłbica spawalnicza z podglądem  
 GB Welding mask  
 D Schweissmaske  
 RUS Щиток сварщика с подсмотром  
 CZ Svářečská přilba s nakoukáváním  
 RO Mască de sudură cu geam  
 H Hegesztősisak kitékintővel  
 E Mascara de soldador con mirador

FILTER SIZE ROZMIAR FILTRA 50x100 mm DIN 8-13	SPECTACLE LENS SIZE SZKIEŁ ROZMIAR 20x100 mm (DIN 5)	195x265 x170 mm	FILTER FILTR DIN 10	WEIGHT WITHOUT LENS WAGA BEZ SZKIEŁ 332 g	
---	---	--------------------	---------------------------	---	--



No.	type	
74447	PSMP	20

- PL Maska spawalnicza  
 GB Welding mask  
 D Schweissmaske  
 RUS Щиток сварщика  
 CZ Svářečská maska  
 RO Mască de sudură  
 H Hegesztőpajzs  
 E Mascara de soldador

110x90 mm	FILTER FILTR DIN 12	
--------------	---------------------------	--



No.	
74441	20



PL Przyłbica spawalnicza  
GB Welding mask  
D Schweissmaske  
RUS Щиток сварщика

CZ Svářečská přilba s nakoukáváním  
RO Mască de sudură cu geam  
H Hegesztősisak kitekintővel  
E Mascara de soldador con mirador



No.	4
74457	20

PL Przyłbica spawalnicza samościemniająca  
GB Auto-darkening welding helmet  
D Schweissmaske, selbstverdunkelnd  
RUS Маска для сварки, самостоятельно затемняющаяся  
CZ Svářečská kukla samostmívaci  
RO Mască de sudură auto-întunecare  
H Őnmagától sötétedő hegesztőpajzs  
E Casco auto-oscurecedor para soldadura

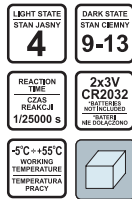

No.	6
74436	6

PL Przyłbica spawalnicza samościemniająca  
GB Auto-darkening welding helmet  
D Schweissmaske, selbstverdunkelnd  
RUS Маска для сварки, самостоятельно затемняющаяся  
CZ Svářečská kukla samostmívaci  
RO Mască de sudură auto-întunecare  
H Őnmagától sötétedő hegesztőpajzs  
E Casco auto-oscurecedor para soldadura

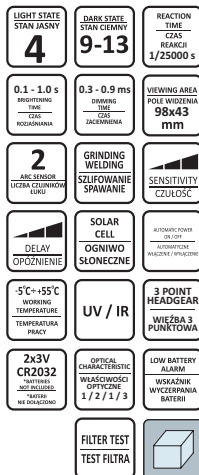

No.	6
74481	6

PL Przyłbica spawalnicza samościemniająca  
GB Auto-darkening welding helmet  
D Schweissmaske, selbstverdunkelnd  
RUS Маска для сварки, самостоятельно затемняющаяся  
CZ Svářečská kukla samostmívaci  
RO Mască de sudură auto-întunecare  
H Őnmagától sötétedő hegesztőpajzs  
E Casco auto-oscurecedor para soldadura

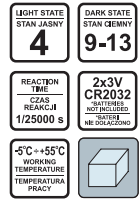

No.	6
74435	6

PL Przyłbica spawalnicza samościemniająca  
GB Auto-darkening welding helmet  
D Schweissmaske, selbstverdunkelnd  
RUS Маска для сварки, самостоятельно затемняющаяся  
CZ Svářečská kukla samostmívaci  
RO Mască de sudură auto-întunecare  
H Őnmagától sötétedő hegesztőpajzs  
E Casco auto-oscurecedor para soldadura

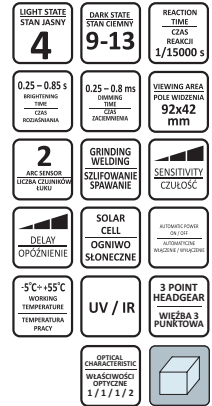

No.	6
74480	6

PL Przyłbica spawalnicza samościemniająca  
GB Auto-darkening welding helmet  
D Schweissmaske, selbstverdunkelnd  
RUS Маска для сварки, самостоятельно затемняющаяся  
CZ Svářečská kukla samostmívaci  
RO Mască de sudură auto-întunecare  
H Őnmagától sötétedő hegesztőpajzs  
E Casco auto-oscurecedor para soldadura

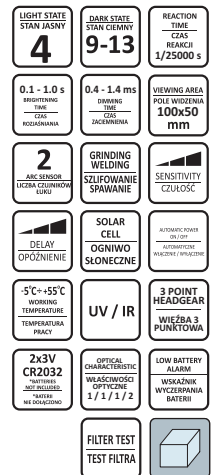

No.	6
74482	6

- PL Przyłbica spawalnicza  
 GB Welding helmet  
 D Schweissermaske  
 RUS Щиток сварщика  
 CZ Svářečská maska  
 RO Mască de sudură  
 H Hegesztőpajzs  
 E Mascara de soldador



No.	mm	type / typ	pcs
74449			12

- PL Filtr spawalniczy  
 GB Welding filter  
 D Vorsatzglas  
 RUS Фильтр для сварки
- CZ Filtr svářečský  
 RO Filtru pt. sudări  
 H Hegesztőszűrő  
 E Pantalla de filtro de soldador



No.	mm	type / typ	pcs
74452	50x100	DIN 8	100
74453	50x100	DIN 9	100
74454	50x100	DIN 10	100
74455	50x100	DIN 11	100
74456	50x100	DIN 12	100

- PL Młotek blacharski, guma - plastik  
 GB Soft faced mallet  
 D Ausbeulhammer  
 RUS Молоток рихтовочный
- CZ Klempířská kladívko  
 RO Ciocan pt. tabla  
 H Bádogos kalapács  
 E Mazo goma-plastico



No.	mm	pcs
33950	35	30/60

- PL Szczypce spawalnicze  
 GB Lock grip pliers  
 D Schweisserzange  
 RUS Ключ - зажим
- CZ Svářečské kleště  
 RO Clește autoblocant pt. sudura  
 H Hegesztő fogó  
 E Alicates de soldar



No.	L (mm)	type	pcs
44300	275	C	6/36

- PL Osłona filtra  
 GB Filter shield  
 D Filterabdeckung  
 RUS Кожух фильтра
- CZ Ochrana filtru  
 RO Apărătoare de filtru  
 H Szűrőfedél  
 E Protección de filtro



No.	mm	type / typ	pcs
74451	50x100	DIN 0	150

- PL Osłona filtra przyłbicy samościemniającej  
 GB Self-dimming helmet filter protection  
 D Filtereinsatz eines selbstabdunkelnden Schutzhelms  
 RUS Кожух фильтра самозатемняющегося шитка  
 CZ Ochranná fólie filtru samostmívající kukly  
 RO Carcasă filtru vizieră heliomată  
 H Hegesztőpajzs szűrő, önsötétedő  
 E Protección del filtro de visera autooscurecedora



No.	mm	pcs	pcs
74439	90x110	5	20

- PL Młotek spawalniczy  
 GB Welder's hammer  
 D Schweisserhammer  
 RUS Молоток сварочный
- CZ Svářečská kladívko  
 RO Ciocan de sudură  
 H Hegesztő kalapács  
 E Martillo para soldar



No.	g	pcs
32110	350	5

- PL Szczypce zaciskowe klamrowe typu „C”  
 GB Welding locking pliers „C” type  
 D Klemm- und Klammerzange vom Typ „C”  
 RUS Клещи давяльные типа „C”  
 CZ Kleště samosvorné upínací typu „C”  
 RO Clește de strângere cu clemă tip „C”  
 H „C” fogó  
 E Pinzas de tornillo (de apriete) de grapa tipo „C”



No.	L (mm)	type	pcs
44301	280	C	6/30

PL Szczypce spawalnicze  
 GB Lock grip pliers  
 D Schweisserzange  
 RUS Ключ - зажим

CZ Svářečské kleště  
 RO Cleste autoblocant pt. sudura  
 H Hegesztő fogó  
 E Alicates de soldar

225  
mm



No.	L (mm)	type	
44400	225	W	6/36

PL Nożyce do blachy  
 GB Figure tin snips  
 D Blechscherer  
 RUS Ножницы по металлу

CZ Nůžky na plech  
 RO Foarfece pt. tablă  
 H Lemezvágó olló  
 E Tijeras para hojalata



No.	max (mm)	
48000	1.5	6/36

PL Nożyce do blachy  
 GB Figure tin snips  
 D Blechscherer  
 RUS Ножницы по металлу

CZ Nůžky na plech  
 RO Foarfece pt. tablă  
 H Lemezvágó olló  
 E Tijeras para hojalata



16



No.	L (mm)	
48080	250	6/36

PL Nożyce do blachy  
 GB Figure tin snips  
 D Blechscherer  
 RUS Ножницы по металлу

CZ Nůžky na plech  
 RO Foarfece pt. tablă  
 H Lemezvágó olló  
 E Tijeras para hojalata

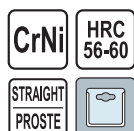

No.	L (mm)	
48082	250	6/36

PL Szczypce spawalnicze  
 GB Lock grip pliers  
 D Schweisserzange  
 RUS Ключ - зажим

CZ Svářečské kleště  
 RO Cleste autoblocant pt. sudura  
 H Hegesztő fogó  
 E Alicates de soldar

250  
mm



No.	L (mm)	type	
44500	250	SM	6/36

PL Nożyce do blachy  
 GB Figure tin snips  
 D Blechscherer  
 RUS Ножницы по металлу

CZ Nůžky na plech  
 RO Foarfece pt. tablă  
 H Lemezvágó olló  
 E Tijeras para hojalata



No.	max (mm)	
48060	1.2	6/48

PL Nożyce do blachy  
 GB Figure tin snips  
 D Blechscherer  
 RUS Ножницы по металлу

CZ Nůžky na plech  
 RO Foarfece pt. tablă  
 H Lemezvágó olló  
 E Tijeras para hojalata



No.	L (mm)	
48100	250	6/60

PL Nożyce do blachy  
 GB Figure tin snips  
 D Blechscherer  
 RUS Ножницы по металлу

CZ Nůžky na plech  
 RO Foarfece pt. tablă  
 H Lemezvágó olló  
 E Tijeras para hojalata



No.	L (mm)	
48200	250	6/60



# 17

## Safes, padlocks & locks Sejfy, klódki i zamki



**Safes**  
Sejfy

246

**Key boxes**  
Skrzynki na klucze

246

**Cash boxes**  
Kasetki na pieniądze

246-247

**Padlocks**  
Kłódki

247-249

**Cast iron padlocks**

Kłódki żeliwne..... 247

**Brass padlocks**

Kłódki mosiężne..... 248

**Lock cylinders & bodies**  
Wkładki do zamków i zamki

249-255

**Brass lock cylinders**

Wkładki mosiężne..... 249

**Door locks**

Zamki do drzwi..... 250

**Bolts & safety chains**

Zasuwki i łańcuchy do drzwi..... 253

**Door closers**

Samozamykacze..... 255

**Door peep holes**

Wizjery..... 255

**Bicycle & motorcycle locks**  
Zamknięcia do rowerów i motocykli

255-257



PL Sejf z zamkiem cyfrowym  
GB Safe with digital lock  
D Seif mit Digitalschloss  
RUS Сейф с электронным замком

CZ Pancéřová pokladna z digitálním zámkem  
RO Seif cu broasca cu cifru  
H Számzáras széf  
E Caja de seguridad con cerradura digital



No.	cm	
78641	35x25x25	1

PL Skrzynka na klucze  
GB Key box  
D Schlüsselkasten  
RUS Ящик для ключей  
CZ Skříňka na klíče  
RO Cutie pt. chei  
H Kulcstartó doboz  
E Caja para llaves

200x160x78 mm

2x 15x HOOKS HACZYKÓW



No.	size / rozmiar (mm)	
78432	200x160x78	20

PL Skrzynka na klucze  
GB Key box  
D Schlüsselkasten  
RUS Ящик для ключей

CZ Skříňka na klíče  
RO Cutie pt. chei  
H Kulcstartó doboz  
E Caja para llaves

450x380x80 mm

2x 80x HOOKS HACZYKÓW



17



No.	size / rozmiar (mm)	
78436	450x380x80	5

PL Kasetka na pieniądze  
GB Cash box  
D Geldkassette  
RUS Ящик для денег  
CZ Kasetá na peníze  
RO Casetá (cutie) pt. bani  
H Pénzes kassetta  
E Caja para efectivo

200x160x90 mm

2x



No.	size / rozmiar (mm)	colour / kolor	
78622	200x160x90		10
78612	200x160x90		10

PL Sejf z zamkiem cyfrowym  
GB Safe with digital lock  
D Seif mit Digitalschloss  
RUS Сейф с электронным замком

CZ Pancéřová pokladna z digitálním zámkem  
RO Seif cu broasca cu cifru  
H Számzáras széf  
E Caja de seguridad con cerradura digital



No.	cm	
78642	31x20x20	1

PL Skrzynka na klucze  
GB Key box  
D Schlüsselkasten  
RUS Ящик для ключей

CZ Skříňka na klíče  
RO Cutie pt. chei  
H Kulcstartó doboz  
E Caja para llaves

250x180x80 mm

2x 48x HOOKS HACZYKÓW



No.	size / rozmiar (mm)	
78434	250x180x80	10

PL Kasetka na pieniądze  
GB Cash box  
D Geldkassette  
RUS Ящик для денег  
CZ Kasetá na peníze  
RO Casetá (cutie) pt. bani  
H Pénzes kassetta  
E Caja para efectivo

150x120x80 mm

2x



No.	size / rozmiar (mm)	colour / kolor	
78620	150x120x80		20
78611	150x120x80		20

PL Kasetka na pieniądze  
GB Cash box  
D Geldkassette  
RUS Ящик для денег  
CZ Kasetá na peníze  
RO Casetá (cutie) pt. bani  
H Pénzes kassetta  
E Caja para efectivo

200x160x90 mm

CODE SZYFR



No.	size / rozmiar (mm)	colour / kolor	
78624	200x160x90		10
78613	200x160x90		10



- PL Kasetka na pieniądze
- GB Cash box
- D Geldkassette
- RUS Ящик для денег
- CZ Kasetka na peníze
- RO Casetă (cutie) pt. bani
- H Pénzes kasszeta
- E Caja para efectivo

250x200x90  
mm

2x 





No.	size / rozmiar (mm)	colour / kolor	
78626	250x200x90		10
78614	250x200x90		10

- PL Kasetka na pieniądze
- GB Cash box
- D Geldkassette
- RUS Ящик для денег
- CZ Kasetka na peníze
- RO Casetă (cutie) pt. bani
- H Pénzes kasszeta
- E Caja para efectivo

300x240x90  
mm

2x 



No.	size / rozmiar (mm)	colour / kolor	
78630	300x240x90		10
78616	300x240x90		10

- PL Kłódka żeliwna
- GB Iron padlock
- D Vorhängeschloss
- RUS Замок навесной
- CZ Stavební visací zámek
- RO Lacăt pt. construcții
- H Óriás lakat
- E Candado de hierro fundido

3x  



No.	L (mm)	
77010	32	6/120
77020	38	6/120
77030	50	6/60
77040	63	6/36
77050	75	6/36

- PL Kłódka żeliwna
- GB Iron padlock
- D Vorhängeschloss
- RUS Замок навесной
- CZ Stavební visací zámek
- RO Lacăt pt. construcții
- H Óriás lakat
- E Candado de hierro fundido

3x  





No.	L (mm)	
77051	32	12/240
77052	38	6/240
77053	50	6/120
77054	63	6/60
77055	75	6/36

- PL Kasetka na pieniądze
- GB Cash box
- D Geldkassette
- RUS Ящик для денег
- CZ Kasetka na peníze
- RO Casetă (cutie) pt. bani
- H Pénzes kasszeta
- E Caja para efectivo

250x180x90  
mm

CODE  
SZYFR





No.	size / rozmiar (mm)	colour / kolor	
78628	250x180x90		10
78615	250x180x90		10

- PL Kasetka na pieniądze
- GB Cash box
- D Geldkassette
- RUS Ящик для денег
- CZ Kasetka na peníze
- RO Casetă (cutie) pt. bani
- H Pénzes kasszeta
- E Caja para efectivo

2x 



No.	size / rozmiar (mm)	colour / kolor	
78632	180x115x55		24
78633	240x155x55		20

- PL Kłódka żeliwna
- GB Iron padlock
- D Vorhängeschloss
- RUS Замок навесной
- CZ Stavební visací zámek
- RO Lacăt pt. construcții
- H Óriás lakat
- E Candado de hierro fundido

3x  



No.	L (mm)	
77061	32	12/120
77062	38	12/120
77063	50	6/60
77064	63	6/36

- PL Kłódka żeliwna powlekana
- GB Alloy covered iron padlock
- D Vorhängeschloss
- RUS Замок навесной
- CZ Stavební visací zámek
- RO Lacăt pt. construcții
- H Óriás lakat
- E Candado de hierro fundido

4x  



No.	L (mm)	
77004	40	12/96
77005	50	12/72
77006	60	12/48

- PL Klódka żeliwna
- GB Iron padlock
- D Vorhängeschloss
- RUS Замок навесной
- CZ Stavební visací zámek
- RO Lacăt pt. construcții
- H Óriás lakat
- E Candado de hierro fundido



No.	L (mm)	
77110	40	6/120
77120	50	6/60
77130	60	6/36
77140	75	6/36
77150	85	6/36

- PL Klódka trzpieniowa
- GB Alloy covered padlock
- D Vorhängeschloss
- RUS Стержневой навесной замок чугунный
- CZ Stavební visací zámek
- RO Lacăt pt. construcții
- H Óriás lakat
- E Candado de mandril de hierro fundido cubierto



No.	L (mm)	
77241	90	6/24

17

- PL Klódka mosiężna
- GB Plated brass padlock
- D Vorhängeschloss
- RUS Замок навесной латунный
- CZ Zámek visací mosazný
- RO Lacăt alama
- H Lakat sárgaréz
- E Candado de latón



No.	L (mm)	
77250	25	12/600
77300	30	12/480
77350	35	12/300
77400	40	12/240
77500	50	12/144
77600	60	12/144

- PL Klódka żeliwna
- GB Alloy covered iron padlock
- D Vorhängeschloss
- RUS Замок навесной
- CZ Stavební visací zámek
- RO Lacăt pt. construcții
- H Óriás lakat
- E Candado de hierro fundido



No.	L (mm)	
77230	40	6/72
77231	50	6/72
77232	60	6/48

- PL Klódka trzpieniowa
- GB Rectangular brass padlock
- D Messigvorhängeschloss
- RUS Стержневой навесной замок латунный
- CZ Visací zámek čepový
- RO Lacăt din alamă cu belciug drept
- H Réz hengerzáras u lakat
- E Candado de latón de mandril



No.	L (mm)	
77210	50	6/120
77211	65	6/96
77212	75	6/60
77213	90	6/36

- PL Klódka mosiężna
- GB Plated brass padlock
- D Vorhängeschloss
- RUS Замок навесной латунный
- CZ Zámek visací mosazný
- RO Lacăt alama
- H Lakat sárgaréz
- E Candado de latón



No.	L (mm)		
77603	25	4	12/120

PL Kłódka sztyfowa  
 GB Brass combination padlock  
 D Vorhängeschloss  
 RUS Замок навесной  
 CZ Zámek visací s číselným klíčem  
 RO Lacat alama cu cifru  
 H Lakat sárgaréz számkombinációs  
 E Candado de latón

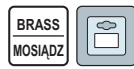

No.		
77607		12/120

PL Wkładka do zamka  
 GB Lock cylinder  
 D Schliesszylinder  
 RUS Личинка замка латунная

CZ Vložka na zámek  
 RO Yală pt. broască  
 H Zárbetét  
 E Inserción cromado



BRASS  
MOSIADZ



No.	L (mm)	mm	key / klucz pcs	
77200	62	31/31	3	12/72
77203	72	31/41	3	12/72
77204	67	31/36	3	12/72
77205	87	36/51	3	12/72

PL Wkładka do zamka  
 GB Lock cylinder  
 D Schliesszylinder  
 RUS Личинка замка латунная

CZ Vložka na zámek  
 RO Yală pt. broască  
 H Zárbetét  
 E Inserción cromado



BRASS  
MOSIADZ



No.	L (mm)	mm	key / klucz pcs	
77190	62	31/31	6	12/72
77191	67	31/36	6	12/72
77192	72	31/41	6	12/72
77193	87	36/51	6	12/72

PL Kłódka mosiężna  
 GB Plated brass padlock  
 D Vorhängeschloss  
 RUS Замк

CZ Zámek visací mosazný  
 RO Lacat alama  
 H Lakat sárgaréz  
 E Candado de latón



No.	mm	
77700	40x105	12/240

PL Wkładka do zamka chromowana  
 GB Lock cylinder  
 D Schliesszylinder  
 RUS Личинка замка

CZ Vložka na zámek  
 RO Yală pt. broască  
 H Zárbetét  
 E Inserción cromado



BRASS  
MOSIADZ



No.	L (mm)	mm	key / klucz pcs	
77170	62	31/31	3	12/72
77171	67	31/36	3	12/72

PL Wkładka do zamka chromowana  
 GB Lock cylinder  
 D Schliesszylinder  
 RUS Личинка замка

CZ Vložka na zámek  
 RO Yală pt. broască  
 H Zárbetét  
 E Inserción cromado



BRASS  
MOSIADZ



No.	L (mm)	mm	key / klucz pcs	
77180	62	31/31	6	12/72

- PL Wkładka do zamka  
 GB Lock cylinder  
 D Schliesszylinder  
 RUS Личинка замка латунная
- CZ Vložka na zámek  
 RO Yală pt. broască  
 H Zárbetét  
 E Inserción cromado



No.	L (mm)	mm	key / klucz pcs	
77195	67	31/36	6	12/72
77196	67	36/31	6	12/72

- PL Zamek wpuszczany bębnekowy  
 GB Mortise lock for keyed cylinder and universal strike plate  
 D Zylinder-Einbauschloss  
 RUS Замок врезной цилиндрический
- CZ Zámek zadlabací vložkový  
 RO Broască cu cilindru  
 H Cilindres bevesőzár  
 E Cerradura empotrada de tambor

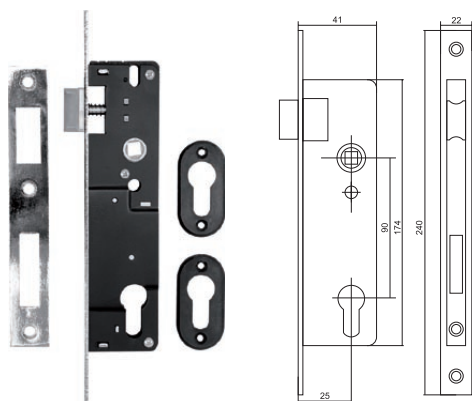
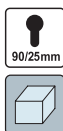

17



No.	mm	
78480	90/25	6/24

- PL Zamek wpuszczany bębnekowy  
 GB Mortise lock for keyed cylinder and universal strike plate  
 D Zylinder-Einbauschloss  
 RUS Замок врезной цилиндрический
- CZ Zámek zadlabací vložkový  
 RO Broască cu cilindru  
 H Cilindres bevesőzár  
 E Cerradura empotrada de tambor

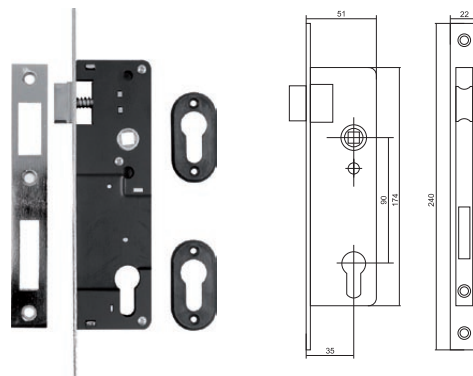

No.	mm	
78482	90/35	6/36

- PL Wkładka do zamka chromowana  
 GB Lock cylinder  
 D Schliesszylinder  
 RUS Личинка замка
- CZ Vložka na zámek  
 RO Yală pt. broască  
 H Zárbetét  
 E Inserción cromado



No.	L (mm)	mm	key / klucz pcs	
77185	67	31/36	6	12/72
77187	72	31/41	6	12/72
77188	72	41/31	6	12/72

- PL Zamek wpuszczany bębnekowy  
 GB Mortise lock for keyed cylinder and universal strike plate  
 D Zylinder-Einbauschloss  
 RUS Замок врезной цилиндрический
- CZ Zámek zadlabací vložkový  
 RO Broască cu cilindru  
 H Cilindres bevesőzár  
 E Cerradura empotrada de tambor

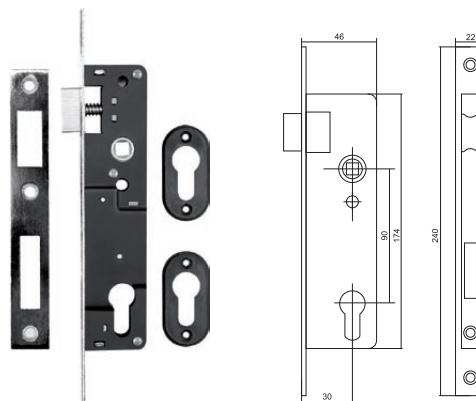
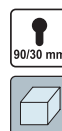

No.	mm	
78481	90/30	6/24

- PL Zamek wpuszczany bębenkowy  
 GB Mortise lock for keyed cylinder and universal strike plate  
 D Zylinder-Einbauschloss  
 RUS Замок врезной цилиндрический

- CZ Zámek zadlabací vložkový  
 RO Broască cu cilindru  
 H Cilindres bevesőzár  
 E Cerradura empotrada de tambor

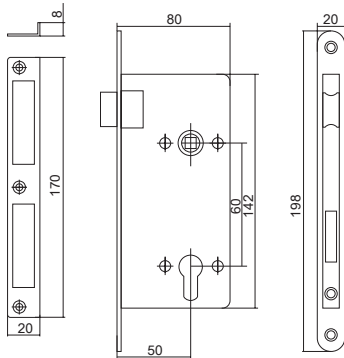

No.	mm	
78490	60/50	6/36

- PL Zamek wpuszczany bębenkowy  
 GB Mortise lock for keyed cylinder and universal strike plate  
 D Zylinder-Einbauschloss  
 RUS Замок врезной цилиндрический

- CZ Zámek zadlabací vložkový  
 RO Broască cu cilindru  
 H Cilindres bevesőzár  
 E Cerradura empotrada de tambor

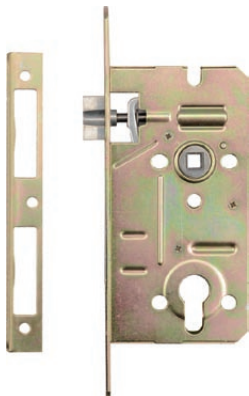
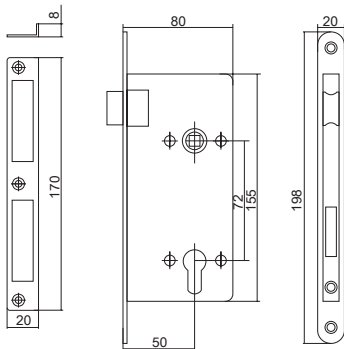

No.	mm	
78493	72/50	6/36

- PL Zamek wpuszczany na klucz  
 GB Mortise lock with lever mechanism and universal strike plate  
 D Einbauschloss für Schlüssel  
 RUS Замок врезной под ключ

- CZ Zámek zadlabací na klíč  
 RO Broască uşă cu cheie  
 H Bevesőzár, kulcsos  
 E Cerradura empotrada de llave

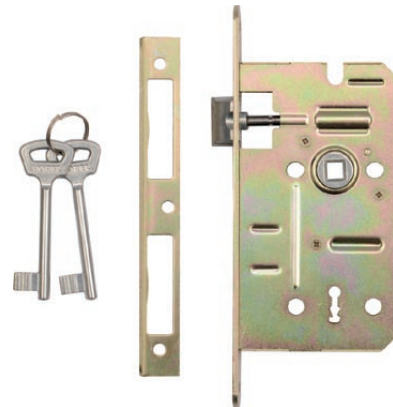
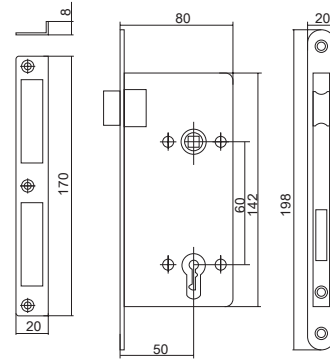

No.	mm	
78491	60/50	6/36

- PL Zamek wpuszczany na klucz  
 GB Mortise lock with lever mechanism and universal strike plate  
 D Einbauschloss für Schlüssel  
 RUS Замок врезной под ключ

- CZ Zámek zadlabací na klíč  
 RO Broască uşă cu cheie  
 H Bevesőzár, kulcsos  
 E Cerradura empotrada de llave

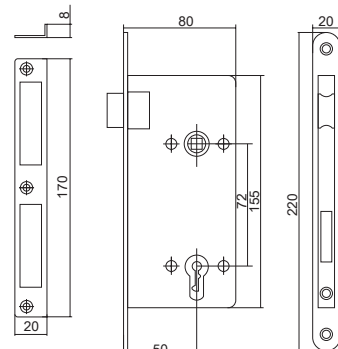

No.	mm	
78494	72/50	6/24

- PL Zamek wpuszczany bębnowy  
 GB Mortise lock for keyed cylinder and universal strike plate  
 D Zylinder-Einbauschloss  
 RUS Замок врезной цилиндрический
- CZ Zámek zadlabací vložkový  
 RO Broască cu cilindru  
 H Cilindres bevesőzár  
 E Cerradura empotrada de tambor

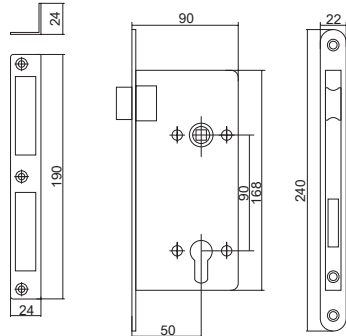

No.	mm	
78500	90/50	12/36

- PL Zamek wpuszczany bębnowy  
 GB Mortise lock for keyed cylinder and universal strike plate  
 D Zylinder-Einbauschloss  
 RUS Замок врезной цилиндрический
- CZ Zámek zadlabací vložkový  
 RO Broască cu cilindru  
 H Cilindres bevesőzár  
 E Cerradura empotrada de tambor

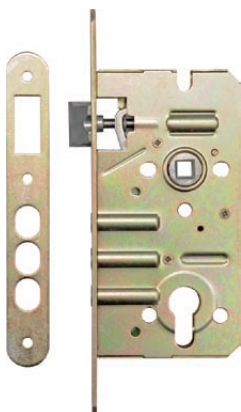
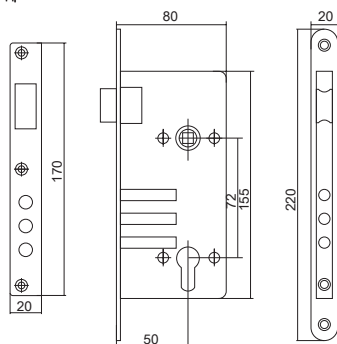

No.	mm	
78510	72/50	6/24

- PL Zamek wpuszczany na klucz  
 GB Mortise lock with lever mechanism and universal strike plate  
 D Einbauschloss für Schlüssel  
 RUS Замок врезной под ключ
- CZ Zámek zadlabací na kľúč  
 RO Broască uşă cu cheie  
 H Bevesőzár, kulcsos  
 E Cerradura empotrada de llave

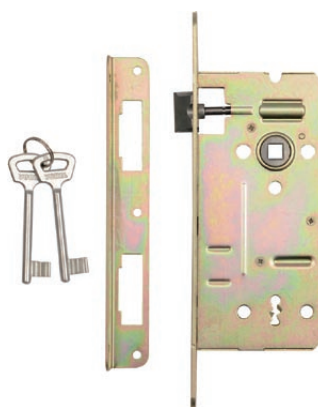
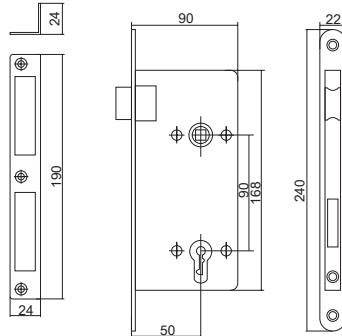

No.	mm	
78501	90/50	6/24

- PL Zamek wpuszczany bębnowy  
 GB Mortise lock for keyed cylinder and universal strike plate  
 D Zylinder-Einbauschloss  
 RUS Замок врезной цилиндрический
- CZ Zámek zadlabací vložkový  
 RO Broască cu cilindru  
 H Cilindres bevesőzár  
 E Cerradura empotrada de tambor

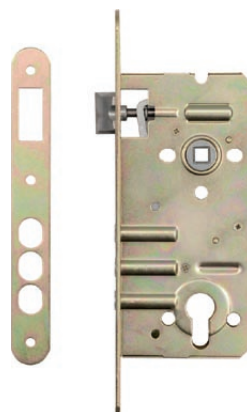
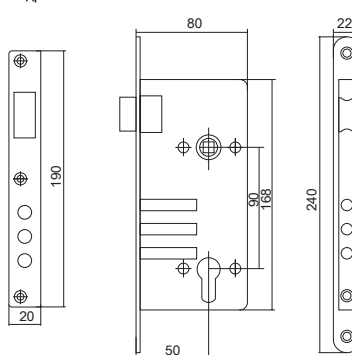

No.	mm	
78511	90/50	6/24

- PL Zamek wpuszczany bębnowy  
 GB Mortise lock for keyed cylinder and universal strike plate  
 D Zylinder-Einbauschloss  
 RUS Замок врезной цилиндрический
- CZ Zámek zadlabací vložkový  
 RO Broască cu cilindru  
 H Cilindres bevéşőzár  
 E Cerradura empotrada de tambor

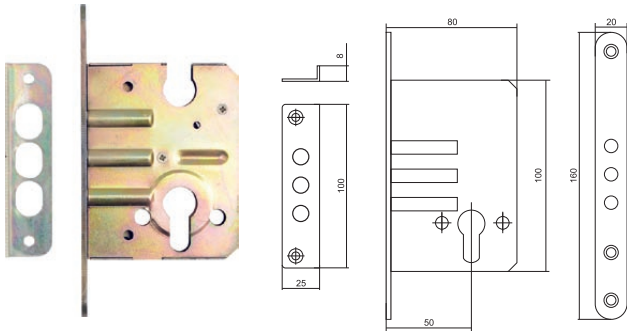

No.	mm	
78513	50	12/48

- PL Zamek wpuszczany łazienkowy  
 GB Mortise lock with one side knob and universal strike plate  
 D Einbauschloss für Badezimmer  
 RUS Замок врезной для ванной комнаты
- CZ Zámek zadlabací pro koupelny  
 RO Broască uşă baie  
 H Bevéşőzár, fürdőszobai  
 E Cerradura empotrada para baños

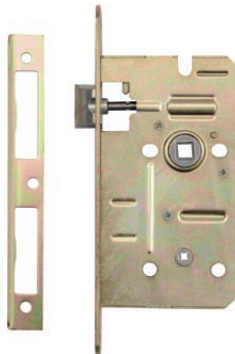
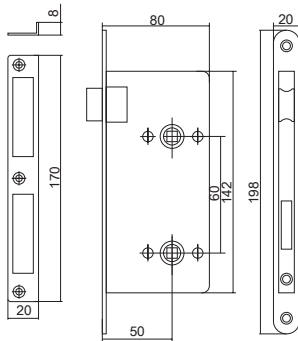

No.	mm	
78525	60/50	6/36

- PL Zasułka mosiądzowana  
 GB Bolt  
 D Türriegel, mit Messingüberzug  
 RUS Задвижка латунированная
- CZ Dveřní zastrč pomosazená  
 RO Zăvor alamă  
 H Sárgaréz tolózár  
 E Cerrojo de latón



No.	slide length / długość trzpienia (mm)	body length / długość obudowy (mm)	striker length / długość obejmę (mm)	height / wysokość (mm)	
76900	40	40	23	26	18/144
76901	50	51	23	26	12/144
76902	63	64	23	26	12/144
76905	121	127	29	35	12/120
76906	138	152	29	35	12/96

- PL Zamek wpuszczany  
 GB Mortise lock for keyed cylinder with latch and bolt  
 D Einbauschloss  
 RUS Замок врезной
- CZ Zámek zadlabací  
 RO Yalá uşă  
 H Bevéşőzár  
 E Cerradura empotrada

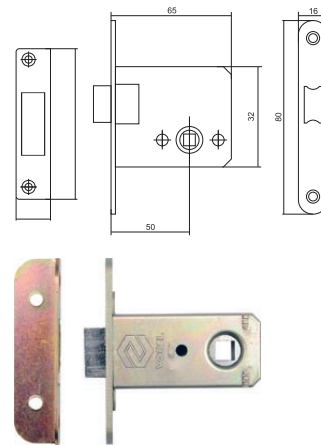
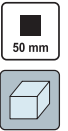

No.	mm	
78520	50	12/72

- PL Zamek wpuszczany łazienkowy  
 GB Mortise lock with one side knob and universal strike plate  
 D Einbauschloss für Badezimmer  
 RUS Замок врезной для ванной комнаты
- CZ Zámek zadlabací pro koupelny  
 RO Broască uşă baie  
 H Bevéşőzár, fürdőszobai  
 E Cerradura empotrada para baños

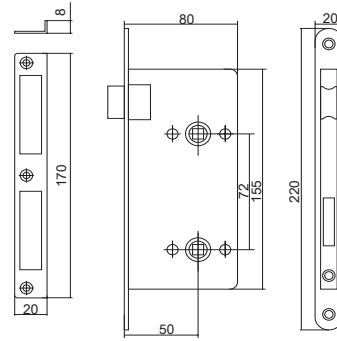

No.	mm	
78526	72/50	6/36



PL Zasuwka mosiądzowana  
GB Bolt  
D Türriegel, mit Messingüberzug  
RUS Задвижка латунированная

CZ Dveřní zastrč pomosazená  
RO Zăvor alamă  
H Sárgaréz tolózár  
E Cerrojo de latón



No.	slide legh / dlugość trzpienia (mm)	body length / dlugość obudowy (mm)	striker length / dlugość obejmę (mm)	height / wysokość (mm)	
76910	50	35	16	40	12/288
76911	63	45	16	40	12/288
76912	75	55	16	40	12/240
76913	100	77	16	40	12/192
76914	125	98	16	40	12/144
76915	150	120	16	40	12/120

PL Zasuwka ocynkowana  
GB Bolt  
D Türriegel, verzinkt  
RUS Задвижка оцинкованная

CZ Dveřní zastrč pozinkovaná  
RO Zăvor zincat  
H Galvanizált tolózár  
E Cerrojo galvanizado



No.	slide legh / dlugość trzpienia (mm)	body length / dlugość obudowy (mm)	striker length / dlugość obejmę (mm)	height / wysokość (mm)	
76941	127	85	27	70	10/60
76942	148	100	27	70	10/60

PL Zasuwka stalowa czerniona  
GB Bolt  
D Stahltürriegel, geschwärzt  
RUS Задвижка стальная вороненая

CZ Dveřní zastrč ocelová černěná  
RO Zăvor de oțel brunat  
H Bamiított acél tolózár  
E Cerrojo de acero pavonado



No.	slide legh / dlugość trzpienia (mm)	body length / dlugość obudowy (mm)	striker length / dlugość obejmę (mm)	height / wysokość (mm)	
76951	133	117	30	45	12/96

PL Zasuwka niklowana  
GB Bolt  
D Türriegel, vernickelt  
RUS Задвижка никелированная

CZ Dveřní zastrč poniklovaná  
RO Zăvor nichel  
H Nikkelezett tolózár  
E Cerrojo niquelado

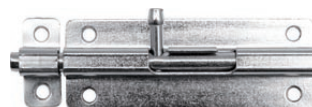

No.	slide legh / dlugość trzpienia (mm)	body length / dlugość obudowy (mm)	striker length / dlugość obejmę (mm)	height / wysokość (mm)	
76930	53	40	13	32	12/288
76931	64	50	13	31	12/288
76933	95	77	15	36	12/192
76934	114	100	15	36	12/144

PL Zasuwka ocynkowana  
GB Bolt  
D Türriegel, verzinkt  
RUS Задвижка оцинкованная

CZ Dveřní zastrč pozinkovaná  
RO Zăvor zincat  
H Galvanizált tolózár  
E Cerrojo galvanizado

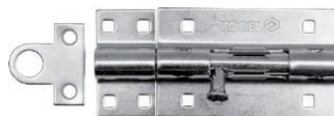

No.	slide legh / dlugość trzpienia (mm)	body length / dlugość obudowy (mm)	striker length / dlugość obejmę (mm)	height / wysokość (mm)	
76943	105	93	38	70	10/40
76944	127	116	38	70	10/40
76945	180	152	38	70	10/30

PL Łańcuch do drzwi  
GB Safety chain  
D Türsicherungskette  
RUS Замок-цепь для двери

CZ Řetěz na dveře  
RO Lanț pt. ușă  
H Ajtólánc  
E Cadena para puerta



No.	
77900	12/120



PL Łańcuch do drzwi  
GB Safety chain  
D Türsicherungskette  
RUS Замок-цепь для двери

CZ Řetěz na dveře  
RO Lanț pt. ușă  
H Ajtólánc  
E Cadena para puerta



No.			
77910		12/120	

PL Wizjer z klapką  
GB Door peep hole with flap  
D Türspion  
RUS Глазок дверной с заслонкой

CZ Hledáček s klapkou  
RO Vizor cu clapă  
H Kitekintő, fedéllel  
E Mirilla con tapa



No.	mm	angle / kať	
77920	35-50	200°	40/480

PL Zawieszki plastikowe do kluczy  
GB Key indicators  
D Schlüsselanhänger  
RUS Брелок для ключей

CZ Přívěšek na klíče  
RO Breloc  
H Kulcstartó  
E Llaveros de plástico



No.	pcs packing	
77930	12	12/120

PL Linka rowerowa  
GB Bicycle lock  
D Fahrradschloss  
RUS Замок велосипедный

CZ Zámek jízdního kola  
RO Antifurt pt. bicicleta  
H Kerékpárzár  
E Cable antirrobo para bicicletas



No.	L (cm)	Ø (mm)	colour / kolor	
77831	65	8		12/120

PL Automacyjny zamykacz do drzwi  
GB Door closer  
D Automatischer Türschließer  
RUS Доводчик дверной

CZ Automatický zavírač dveří  
RO Încuietoare automată ușă  
H Ajtófék  
E Muelle de puerta



No.	kg	
78463	45-65	10

PL Wizjer z klapką  
GB Door peep hole with flap  
D Türspion  
RUS Глазок дверной с заслонкой

CZ Hledáček s klapkou  
RO Vizor cu clapă  
H Kitekintő, fedéllel  
E Mirilla con tapa



No.	mm	angle / kať	
77921	35-50	200°	40/480

PL Linka rowerowa  
GB Bicycle lock  
D Fahrradschloss  
RUS Замок велосипедный

CZ Zámek jízdního kola  
RO Antifurt pt. bicicleta  
H Kerékpárzár  
E Cable antirrobo para bicicletas



No.	L (cm)	Ø (mm)	colour / kolor	
77830	65	8		12/120

PL Linka rowerowa  
GB Bicycle lock  
D Fahrradschloss  
RUS Замок велосипедный

CZ Zámek jízdního kola  
RO Antifurt pt. bicicleta  
H Kerékpárzár  
E Cable antirrobo para bicicletas



No.	L (cm)	Ø (mm)	colour / kolor	
77833	120	8		10/60
77834	120	10		10/60
77835	180	10		10/60

PL Linka rowerowa  
GB Bicycle lock  
D Fahrradschloss  
RUS Замок велосипедный

CZ Zámek jízdního kola  
RO Antifurt pt. bicicleta  
H Kerékpárzár  
E Cable antirrobo para bicicletas



**VOREL**

No.	L (cm)	Ø (mm)	colour / kolor	
77837	120	8		10/60
77838	150	10		10/60

PL Linka rowerowa  
GB Bicycle lock  
D Fahrradschloss  
RUS Замок велосипедный

CZ Zámek jízdního kola  
RO Antifurt pt. bicicleta  
H Kerékpárzár  
E Cable antirrobo para bicicletas



**VOREL**

No.	L (cm)	Ø (mm)	colour / kolor	
77840	180	12		10/40

PL Zapięcie rowerowe  
GB Bicycle lock  
D Fahrradschloss  
RUS Замок велосипедный

CZ Zámek jízdního kola  
RO Antifurt pt. bicicleta  
H Kerékpárzár  
E Cable antirrobo para bicicletas



**VOREL**

No.	L (cm)	Ø (mm)	
77850	100	18	12/24

PL Zapięcie rowerowe  
GB Bicycle lock  
D Fahrradschloss  
RUS Замок велосипедный

CZ Zámek jízdního kola  
RO Antifurt pt. bicicleta  
H Kerékpárzár  
E Cable antirrobo para bicicletas



**VOREL**

No.	L (cm)	Ø (mm)	
77852	120	20	12/24

PL Linka rowerowa  
GB Bicycle lock  
D Fahrradschloss  
RUS Замок велосипедный

CZ Zámek jízdního kola  
RO Antifurt pt. bicicleta  
H Kerékpárzár  
E Cable antirrobo para bicicletas

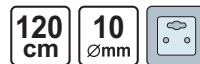

**VOREL**

No.	L (cm)	Ø (mm)	colour / kolor	
77845	120	10		20/40

PL Linka stalowa z klódką  
GB Security cable and lock  
D Stahlseil, mit Vorhängeschloss  
RUS Канат стальной с замком

CZ Ocelové lanko s visacím zámekem  
RO Sârmă de oțel cu lacăt  
H Drótkötél, lakattal  
E Cuerda de acero con candado

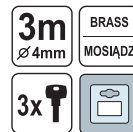

**VOREL**

No.	L (m)	Ø (mm)	
77815	3	4	12/48

PL Zapięcie rowerowe  
GB Bicycle lock  
D Fahrradschloss  
RUS Замок велосипедный

CZ Zámek jízdního kola  
RO Antifurt pt. bicicleta  
H Kerékpárzár  
E Cable antirrobo para bicicletas



**VOREL**

No.	L (cm)	Ø (mm)	
77851	120	18	12/24

PL Zapięcie motocyklowe  
GB Motorcycle lock  
D Stahlgliederschloss  
RUS Замок до мотоцикла

CZ Zámek na kolo  
RO Anti-furt motocicletă  
H Láncslakat motorbiciklihez  
E Candado para Moto



**VOREL**

No.	L (cm)	Ø (mm)	
77860	100	22	12

- PL Zapięcie motocyklowe  
 GB Motorcycle lock  
 D Stahlgliederschloss  
 RUS Замок до мотоцикла
- CZ Zámek na kolo  
 RO Anti-furt motocicletă  
 H Láncslakát motorbiciklihez  
 E Candado para Moto



No.	L (cm)	Ø (mm)	☐
77861	150	25	6/12

- PL Zapięcie typu U-lock  
 GB U-type lock  
 D Bügelschloss  
 RUS Замок до мотоцикла
- CZ Zámek na kolo „U” typ  
 RO Anti-furt tip „U”  
 H U-lakat motorbiciklihez  
 E Candado tipo „U”



No.	L (cm)	Ø (mm)	☐
77870	21	13	10/20

- PL Zapięcie typu U-lock  
 GB U-type lock  
 D Bügelschloss  
 RUS Замок до мотоцикла
- CZ Zámek na kolo „U” typ  
 RO Anti-furt tip „U”  
 H U-lakat motorbiciklihez  
 E Candado tipo „U”



No.	L (cm)	Ø (mm)	☐
77872	30	15	5/10

- PL Zapięcie łańcuchowe z zamkiem  
 GB Chain lock  
 D Kettenverschluss mit Schloss  
 RUS Цепь с замком
- CZ Bezpečnostní řetěz se zámkem  
 RO Încuietoare lanț cu lacăt  
 H Kerékpár lakat  
 E Candado de cadena con cerradura



No.	L (cm)	Ø (mm)	☐
77881	120	7	12

- PL Zapięcie typu U-lock  
 GB U-type lock  
 D Bügelschloss  
 RUS Замок до мотоцикла
- CZ Zámek na kolo „U” typ  
 RO Anti-furt tip „U”  
 H U-lakat motorbiciklihez  
 E Candado tipo „U”

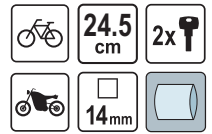

No.	L (cm)	☐ (mm)	☐
77871	24.5	14	6/12

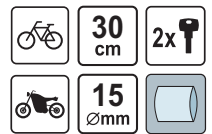

Memo



# 18

## Tool bags & boxes Torby i skrzynki narzędziowe

**Tool bags & boxes**  
**Torby i skrzynki narzędziowe**

.....260-262

**Tool bags**

Torby narzędziowe..... 260

**Leather tool belts**

Skórzane pasy narzędziowe..... 260

**Plastic tool boxes**

Plastikowe skrzynki narzędziowe..... 260

- PL Torba narzędziowa  
GB Tool bag  
D Werkzeugkoffer  
RUS Сумка для инструмента
- CZ Nástrojová taška  
RO Geantă pt. scule  
H Szerszámotáska  
E Maletín de herramientas



No.	dimensions / wymiary (mm)	
78700	380x250x110	4
78710	455x280x130	2

- PL Torba narzędziowa  
GB Tool bag  
D Werkzeugkoffer  
RUS Сумка для инструмента
- CZ Nástrojová taška  
RO Geantă pt. scule  
H Szerszámotáska  
E Maletín de herramientas



No.	dimensions / wymiary (mm)	
78730	400x260x140	2

- PL Skrzynka narzędziowa  
GB Tool box  
D Plastikwerkzeugkoffer  
RUS Ящик для инструмента-пластмассовый
- CZ Nástrojová skříňka plastikov  
RO Cutie din plastic pt. scule  
H Szerszámotáska, műanyag  
E Caja de herramientas de plástico



VOREL

No.	size / rozmiar	dimensions / wymiary (mm)	
78801	12" (30 cm)	312x167x130	1
78800	16" (40 cm)	415x226x200	1

- PL Skrzynka narzędziowa  
GB Tool box  
D Plastikwerkzeugkoffer  
RUS Ящик для инструмента-пластмассовый
- CZ Nástrojová skříňka plastikov  
RO Cutie din plastic pt. scule  
H Szerszámotáska, műanyag  
E Caja de herramientas de plástico



VOREL

No.	size / rozmiar	dimensions / wymiary (mm)	
78811	12" (30 cm)	312x167x130	1
78812	16" (40 cm)	415x226x200	1
78813	20" (50 cm)	525x256x246	1
78815	26" (65 cm)	595x337x316	1

- PL Torba narzędziowa  
GB Tool bag  
D Werkzeugkoffer  
RUS Сумка для инструмента
- CZ Nástrojová taška  
RO Geantă pt. scule  
H Szerszámotáska  
E Maletín de herramientas



No.	dimensions / wymiary (mm)	
78720	430x285x170	2

- PL Pas monterski  
GB Tool belt  
D Leder-gürteltasche  
RUS Пояс монтажника кожаный
- CZ Montéřský pás kožený  
RO Centura port scule - piele  
H Bőr szerszámotás  
E Cinturon de montaje de piel



No.		
78750		50

- PL Skrzynka narzędziowa  
GB Tool box  
D Plastikwerkzeugkoffer  
RUS Ящик для инструмента-пластмассовый
- CZ Nástrojová skříňka plastikov  
RO Cutie din plastic pt. scule  
H Szerszámotáska, műanyag  
E Caja de herramientas de plástico



VOREL

No.	size / rozmiar	dimensions / wymiary (mm)	
78802	20" (50 cm)	525x256x246	1

- PL Skrzynka narzędziowa  
GB Tool box  
D Plastikwerkzeugkoffer  
RUS Ящик для инструмента-пластмассовый
- CZ Nástrojová skříňka plastikov  
RO Cutie din plastic pt. scule  
H Szerszámotáska, műanyag  
E Caja de herramientas de plástico



VOREL

No.	size / rozmiar	dimensions / wymiary (mm)	load capacity / noşność (kg)	
78814	20" (50 cm)	525x256x325	25 + 3	1

PL Szufladki warsztatowe  
 GB Workshop drawers  
 D Werkstattschubfächer  
 RUS Ящики для инструментов  
 CZ Skříňka se zásobníky  
 RO Sertare atelier  
 H Műhely zsámoly fiókkal  
 E Cajones para taller



No.	dimensions / wymiary (mm)	compartments / szufladki	
78785	225x155x100	10	20

PL Organizer Domino  
 GB Organizer  
 D Werkzeugkaste  
 RUS Органайзер  
 CZ Organizér  
 RO Cutie tip organizator  
 H Mű. csavartartó doboz  
 E Caja



No.	dimensions / wymiary (mm)	compartments / przegródki	
78793	120x100x30	8	38

PL Organizer  
 GB Organizer  
 D Werkzeugkaste  
 RUS Органайзер  
 CZ Organizér  
 RO Cutie tip organizator  
 H Mű. csavartartó doboz  
 E Caja



No.	dimensions / wymiary (mm)	
78816	310x210x55	10
78818	350x250x55	10

PL Organizer  
 GB Organizer  
 D Werkzeugkaste  
 RUS Органайзер  
 CZ Organizér  
 RO Cutie tip organizator  
 H Mű. csavartartó doboz  
 E Caja



No.	dimensions / wymiary (mm)	
78819	460x320	5

PL Organizer  
 GB Organizer  
 D Werkzeugkaste  
 RUS Органайзер  
 CZ Organizér  
 RO Cutie tip organizator  
 H Mű. csavartartó doboz  
 E Caja



No.	dimensions / wymiary (mm)	compartments / przegródki	
78790	200x145x35	7	10

PL Organizer  
 GB Organizer  
 D Werkzeugkaste  
 RUS Органайзер  
 CZ Organizér  
 RO Cutie tip organizator  
 H Mű. csavartartó doboz  
 E Caja



No.	dimensions / wymiary (mm)	compartments / przegródki	
78791	300x220x55	10	10

PL Organizer Domino  
 GB Organizer  
 D Werkzeugkaste  
 RUS Органайзер  
 CZ Organizér  
 RO Cutie tip organizator  
 H Mű. csavartartó doboz  
 E Caja



No.	dimensions / wymiary (mm)	
78794	360x270	5

PL Pojemnik magazynowy  
 GB Storage case  
 D Lagersichtbox  
 RUS Ящик для склада  
 CZ Box skladovací  
 RO Cutie scule diverse  
 H Tárolók  
 E Contenedor de almacen



No.	type	dimensions / wymiary (mm)	
78821	P-1	108x110x75	40
78822	P-2	160x115x75	40
78824	P-4	235x173x125	20
78825	P-5	340x200x150	9
78826	P-6	440x315x180	6

- PL Pojemnik magazynowy
- GB Container
- D Vorratsbehälter
- RUS Ящик складской
- CZ Box skladovací
- RO Cutie depozitare
- H Tároló doboz
- E Caja de almacenamiento



No.	type / typ	dimensions / wymiary (mm)	
78830	XS	116x112x75	270
78831	S	116x161x75	190
78833	M	170x240x126	44
78834	L	204x340x155	27
78835	XL	333x500x187	7

- PL Przykrywka do pojemnika magazynowego
- GB Container cover
- D Lagerbehälter Deckel
- RUS Крышка к ящику складскому
- CZ Viko na kontejner
- RO Capac cutie de depozitare
- H Láda fedél
- E Tapa para recipiente



No.	dimensions / wymiary (mm)	for / dla	
78832	116x212x75	78831	54

Memo



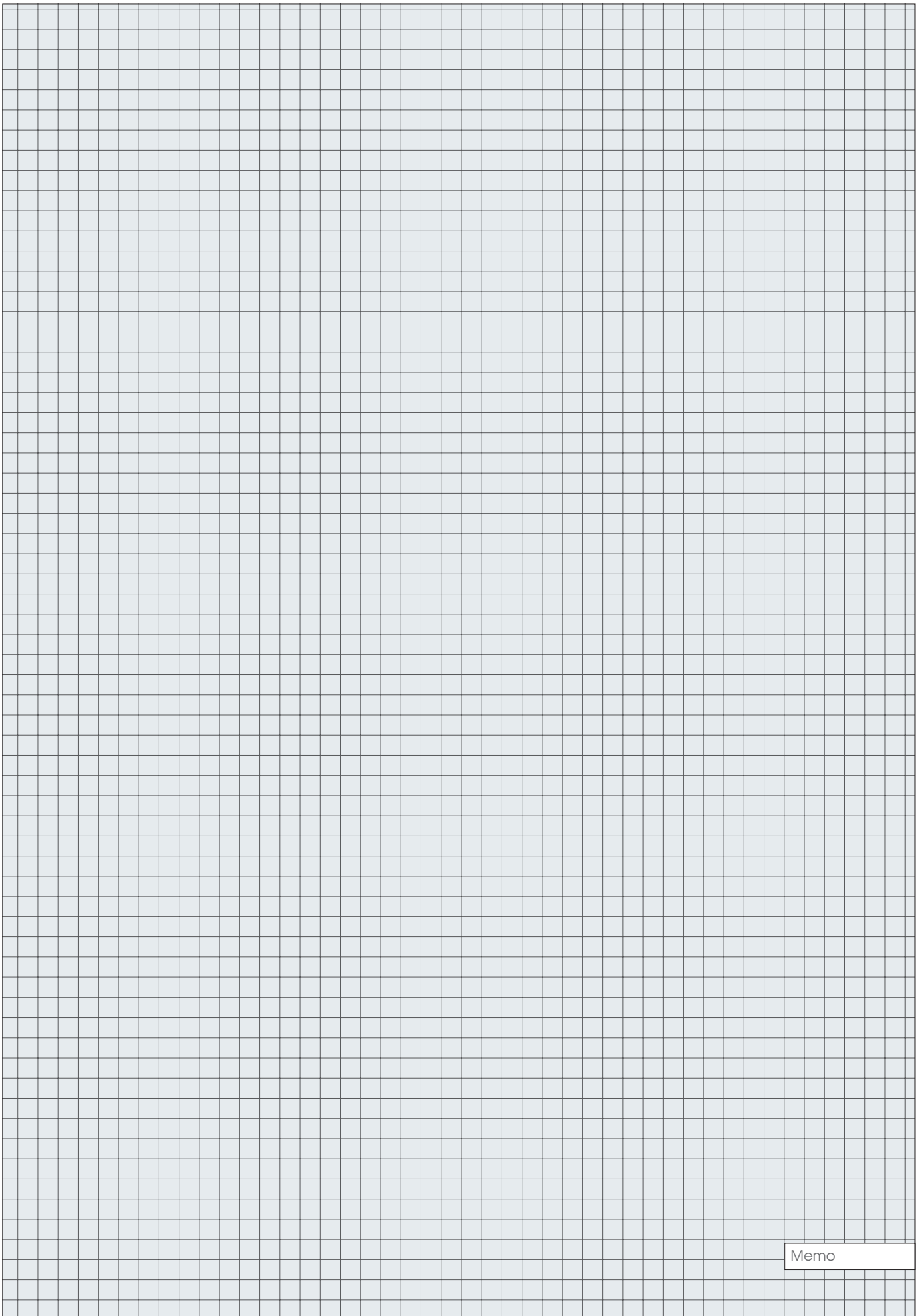





Memo

# 19

## Bicycle accessories Akcesoria rowerowe



<b>Bicycle lamps</b> Lampy rowerowe	
..... 266	
<b>Bicycle &amp; motorcycle locks</b> Zamknięcia do rowerów i motocykli	
..... 266-268	
<b>Bicycle pumps</b> Pompki rowerowe	
..... 268-269	
<b>Bicycle tools</b> Narzędzia rowerowe	
..... 269-270	

- PL LED front bike light  
 GB Fahrrad Frontscheinwerfer LED  
 D Lampe rowerowa przednia LED  
 RUS Светодиодный фонарик для велосипеда
- CZ Přední světla LED na kolo  
 RO Lanterna pt. bicicleta LED  
 H LED-os első kerékpár lámpa  
 E Linterna LED frontal para bicicleta

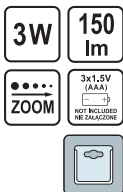

**POWER LED**



**VOREL**

No.	battery / bateria	
88411	3x1.5V	12/48

- PL LED bike light set  
 GB Fahrrad-Beleuchtungsset LED  
 D Zestaw lamp rowerowych LED  
 RUS Набор светодиодных велосипедных фонарей
- CZ Set LED osvětlení na kolo  
 RO Set lanterna bicicleta LED  
 H LED kerékpár lámpa szett  
 E Juego de luces LED para bicicleta

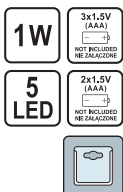

**POWER LED**



**VOREL**

No.	battery / bateria	
88421	3x1.5V / 2x1.5V	12/120

- PL Linka rowerowa  
 GB Bicycle lock  
 D Fahrradschloss  
 RUS Замок велосипедный
- CZ Zámek jízdního kola  
 RO Antifurt pt. bicicleta  
 H Kerékpárzár  
 E Cable antirrobo para bicicletas



**VOREL**

No.	L (cm)	Ø (mm)	colour / kolor	
77831	65	8	● ● ●	12/120



- PL Linka rowerowa  
 GB Bicycle lock  
 D Fahrradschloss  
 RUS Замок велосипедный
- CZ Zámek jízdního kola  
 RO Antifurt pt. bicicleta  
 H Kerékpárzár  
 E Cable antirrobo para bicicletas



**VOREL**

No.	L (cm)	Ø (mm)	colour / kolor	
77837	120	8	● ● ●	10/60
77838	150	10	● ● ●	10/60



- PL LED bike light set  
 GB Fahrrad-Beleuchtungsset LED  
 D Zestaw lamp rowerowych LED  
 RUS Набор светодиодных велосипедных фонарей
- CZ Set LED osvětlení na kolo  
 RO Set lanterna bicicleta LED  
 H LED kerékpár lámpa szett  
 E Juego de luces LED para bicicleta



**POWER LED**



**VOREL**

No.	battery / bateria	
88422	3x1.5V / 2x1.5V	12/48

- PL Linka rowerowa  
 GB Bicycle lock  
 D Fahrradschloss  
 RUS Замок велосипедный
- CZ Zámek jízdního kola  
 RO Antifurt pt. bicicleta  
 H Kerékpárzár  
 E Cable antirrobo para bicicletas



**VOREL**

No.	L (cm)	Ø (mm)	colour / kolor	
77830	65	8	● ● ●	12/120



- PL Linka rowerowa  
 GB Bicycle lock  
 D Fahrradschloss  
 RUS Замок велосипедный
- CZ Zámek jízdního kola  
 RO Antifurt pt. bicicleta  
 H Kerékpárzár  
 E Cable antirrobo para bicicletas



**VOREL**

No.	L (cm)	Ø (mm)	colour / kolor	
77833	120	8	● ● ●	10/60
77834	120	10	● ● ●	10/60
77835	180	10	● ● ●	10/60



- PL Linka rowerowa  
 GB Bicycle lock  
 D Fahrradschloss  
 RUS Замок велосипедный
- CZ Zámek jízdního kola  
 RO Antifurt pt. bicicleta  
 H Kerékpárzár  
 E Cable antirrobo para bicicletas



**VOREL**

No.	L (cm)	Ø (mm)	colour / kolor	
77845	120	10	● ● ●	20/40



- PL Linka rowerowa  
GB Bicycle lock  
D Fahrradschloss  
RUS Замок велосипедный

- CZ Zámek jízdního kola  
RO Antifurt pt. bicicleta  
H Kerékpárzár  
E Cable antirobo para bicicletas



No.	L (cm)	Ø (mm)	colour / kolor	
77840	180	12		10/40

- PL Zapięcie rowerowe  
GB Bicycle lock  
D Fahrradschloss  
RUS Замок велосипедный

- CZ Zámek jízdního kola  
RO Antifurt pt. bicicleta  
H Kerékpárzár  
E Cable antirobo para bicicletas



No.	L (cm)	Ø (mm)	
77850	100	18	12/24

- PL Zapięcie rowerowe  
GB Bicycle lock  
D Fahrradschloss  
RUS Замок велосипедный

- CZ Zámek jízdního kola  
RO Antifurt pt. bicicleta  
H Kerékpárzár  
E Cable antirobo para bicicletas



No.	L (cm)	Ø (mm)	
77852	120	20	12/24

- PL Zapięcie motocyklowe  
GB Motorcycle lock  
D Stahlgliederschloss  
RUS Замок до мотоцикла

- CZ Zámek na kolo  
RO Anti-furt motocicletă  
H Láncakát motorbiciklihez  
E Candado para Moto



No.	L (cm)	Ø (mm)	
77861	150	25	6/12

- PL Linka stalowa z kłódką  
GB Security cable and lock  
D Stahseil, mit Vorhängeschloss  
RUS Канат стальной с замком

- CZ Ocelové lanko s visacím zámekem  
RO Sârmă de oțel cu lacăt  
H Drótkötél, lakattal  
E Cuerda de acero con candado



No.	L (m)	Ø (mm)	
77815	3	4	12/48

- PL Zapięcie rowerowe  
GB Bicycle lock  
D Fahrradschloss  
RUS Замок велосипедный

- CZ Zámek jízdního kola  
RO Antifurt pt. bicicleta  
H Kerékpárzár  
E Cable antirobo para bicicletas



No.	L (cm)	Ø (mm)	
77851	120	18	12/24

- PL Zapięcie motocyklowe  
GB Motorcycle lock  
D Stahlgliederschloss  
RUS Замок до мотоцикла

- CZ Zámek na kolo  
RO Anti-furt motocicletă  
H Láncakát motorbiciklihez  
E Candado para Moto

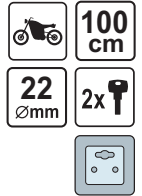

No.	L (cm)	Ø (mm)	
77860	100	22	12

- PL Zapięcie łańcuchowe z zamkiem  
GB Chain lock  
D Kettenverschluss mit Schloss  
RUS Цепь с замком

- CZ Bezpečnostní řetěz se zámekem  
RO Încuietoare lanț cu lacăt  
H Kerékpár lakat  
E Candado de cadena con cerradura



No.	L (cm)	Ø (mm)	
77881	120	7	12

PL Zapięcie typu U-lock  
GB U-type lock  
D Bügelschloss  
RUS Замок до мотоцикла

CZ Zámek na kolo „U” typ  
RO Anti-furt tip „U”  
H U-lakat motorbiciklilhez  
E Candado tipo „U”



**VOREL**

No.	L (cm)	Ø (mm)	☐
77870	21	13	10/20

PL Zapięcie typu U-lock  
GB U-type lock  
D Bügelschloss  
RUS Замок до мотоцикла

CZ Zámek na kolo „U” typ  
RO Anti-furt tip „U”  
H U-lakat motorbiciklilhez  
E Candado tipo „U”



**VOREL**

No.	L (cm)	Ø (mm)	☐
77872	30	15	5/10

PL Pompka rowerowa  
GB Bike hand pump  
D Fahrradpumpe  
RUS Велосипед ручной насос

CZ Pumpyčka na kolo  
RO Pompă de bicicletă  
H Kerékpár pumpa  
E Bomba de bicicleta



**VOREL**

No.	☐
82032	60

PL Pompka łukowa nożna  
GB Foot pump  
D Fussluftpumpe mit manometer  
RUS Насос ножной с манометром

CZ Nožní pumpa z manometrem  
RO Pompă de picior  
H Lábpumpa nyomásmérővel  
E Bomba de pierna con manometro



No.	MPa	☐
82005	0.7	5

PL Zapięcie typu U-lock  
GB U-type lock  
D Bügelschloss  
RUS Замок до мотоцикла

CZ Zámek na kolo „U” typ  
RO Anti-furt tip „U”  
H U-lakat motorbiciklilhez  
E Candado tipo „U”

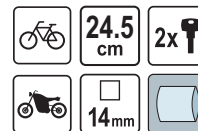

**VOREL**

No.	L (cm)	☐ (mm)	☐
77871	24.5	14	6/12

PL Teleskopowa pompka aluminiowa  
GB Double cylinder aluminium hand pump  
D Aluminium Handpumpe Doppelzylinder  
RUS Насос телескопический алюминиевый

CZ Pumpa ruční double-pístové hliníkové  
RO Pompa Aluminium duo telescope  
H Pumpa alumíniium dupla dugattyús  
E Bomba de mano de doble cilindro de aluminio



**VOREL**

No.	☐
82031	60

PL Pompka nożna z manometrem  
GB Foot pump with manometer  
D Fussluftpumpe mit manometer  
RUS Насос ножной с манометром

CZ Nožní pumpa z manometrem  
RO Pompă de picior cu manometru  
H Lábpumpa nyomásmérővel  
E Bomba de pierna con manometro



No.	☐
82000	20

PL Pompka łukowa nożna  
GB Foot pump  
D Fussluftpumpe mit manometer  
RUS Насос ножной с манометром

CZ Nožní pumpa z manometrem  
RO Pompă de picior  
H Lábpumpa nyomásmérővel  
E Bomba de pierna con manometro



**VOREL**

No.	MPa	☐
82001	0-0.7	12

- PL Pompka tłokowa nożna  
 GB Foot pump  
 D Fussluftpumpe mit manometer  
 RUS Насос ножной с манометром
- CZ Nožní pumpa z manometrem  
 RO Pompa de picior  
 H Lábpumpa nyomásmérővel  
 E Bomba de pierna con manometro



**VOREL**

No.	MPa	
82015	0-0.7	6

- PL Pompka słupkowa z manometrem  
 GB Hand pump with manometer  
 D Hand-Luftpumpe mit Manometer  
 RUS Насос ручной с манометром  
 CZ Pumpa z manometrem  
 RO Pompa de mana cu manometru  
 H Kézi pumpa manométerrel  
 E Bomba de barrote con manometro



**VOREL**

No.	MPa	
82021	1	10

- PL Zestaw do naprawy roweru  
 GB Bike hand tool set  
 D Fahrrad-Reparatur-Set  
 RUS Набор инструментов для велосипеда  
 CZ Cyklistické nářadí  
 RO Instrumente ciclism  
 H Kerékpár szerszámok  
 E Herramientas Ciclismo

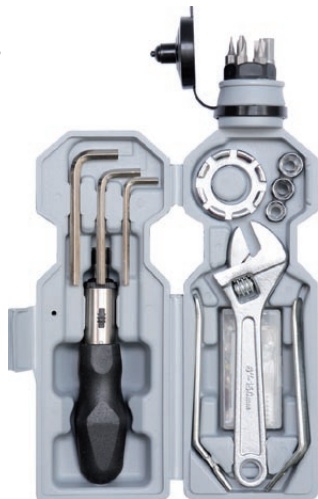

**VOREL**

No.	
77795	20

- Set includes / Zestaw zawiera:  
 - Hex key / Klucze imbusowe:  
 4mm, 5mm, 6mm  
 - Ratchet screwdriver / Wkrętak z grzechotką  
 - Adjustable wrench / Klucz nastawny  
 - Crowbar / Łyzki do opon rowerowych: x2  
 - Sockets / Nasadki: 8mm, 9mm, 10mm  
 - Wheels spokes wrench / Klucz do regulacji szprych  
 - Bits set + adaptor / Zestaw końcówek wkrętakowych + adapter  
 - Tire repair kit / Zestaw naprawy do dętek

- PL Pompka słupkowa ręczna  
 GB Hand pump  
 D Hand-Luftpumpe  
 RUS Насос ручной  
 CZ Hustička ruční  
 RO Pompa de mana cu manometru  
 H Kézi pumpa  
 E Bomba de barrote de mano



No.	MPa	
82020	0.3	20

- PL Pompka słupkowa z manometrem  
 GB Hand pump with manometer  
 D Hand-Luftpumpe mit Manometer  
 RUS Насос ручной с манометром  
 CZ Pumpa z manometrem  
 RO Pompa de mana cu manometru  
 H Kézi pumpa manométerrel  
 E Bomba de barrote con manometro



**VOREL**

No.	MPa	
82022	0.1-1	10

- PL Zestaw kluczy imbusowych  
 GB Hex key set  
 D Sechskant-Stiftschluselsatz  
 RUS Набор шестигранников
- CZ Imbusové klíče  
 RO Chei imbus  
 H Imbisz kulcs  
 E Juego de llaves hex



**VOREL**

No.	mm	pcs	
56505	1.5; 2; 2.5; 3; 4; 5; 6; 8	8	25/100

- PL Zestaw kluczy imbusowych  
 GB Hex key set  
 D Sechskant-Stiftschluselsatz  
 RUS Набор шестигранников
- CZ Imbusové klíče  
 RO Chei imbus  
 H Imbisz kulcs  
 E Juego de llaves hex



**VOREL**

No.	mm	pcs	
56506	1.5; 2; 2.5; 3; 4; 5; 6; 8	8	25/100

PL Zestaw kluczy Torx  
 GB Torx key set  
 D Torx-Stiftschluselsatz  
 RUS Набор ключей Torx

CZ Souprava klíčů Torx  
 RO Set de chei Torx  
 H Kulcskészlet, Torx  
 E Juego de llaves Torx

8 PCS	CrV 6150	TORX
T9 T10 T15 T20 T25 T27 T30 T40		



No.	pcs	
56507	8	25/100

PL Stojak do obsługi rowerów  
 GB Bike repair stand  
 D Fahrrad montagesänder  
 RUS Стенд для ремонта велосипедов  
 CZ Montážní stojan  
 RO Stand pt. repararea bicicletei  
 H Kerékpár szerelő  
 E Soporte de reparación



 105-145 cm
 360°
 max 30 kg
 ∅ 25-80 mm



No.	
77715	2

Memo



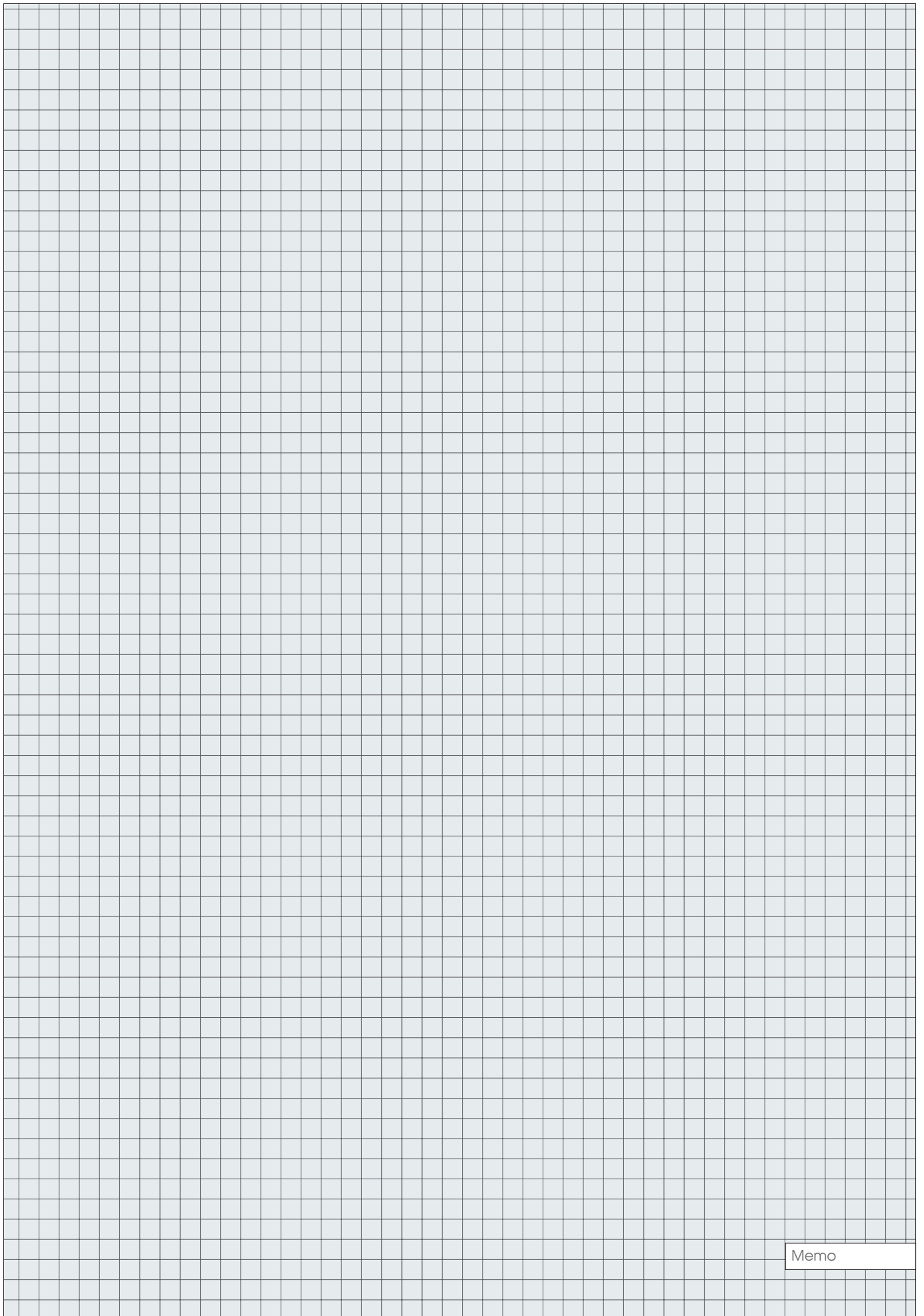













Memo

20

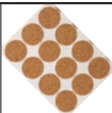
Household equipment  
Gospodarstwo domowe



<b>Mailboxes</b> Skrzynki na listy		274-275	<b>Pumps</b> Pompki		285
<b>Coal stoves &amp; accessories</b> Piecyki węglowe i akcesoria		275-278	<b>Hydraulic accessories</b> Akcesoria hydrauliczne		285
<b>Brushes</b> Szczotki		279-280	<b>Vaselines</b> Wazeliny techniczne		285
<b>Mops</b> Zgarniacze do wody		280	<b>Hand trucks</b> Wózki magazynowe		286
<b>Snow shovels</b> Łopaty do śniegu		280-281	<b>Casters</b> Kółka		286-288
<b>Bags</b> Worki		281-282	<b>Seals</b> Uszczelnienia		288-289
<b>Tarpaulins</b> Plandeki		282-283	<b>Self-adhesive furniture pads</b> Podkładki samoprzylepne pod meble		289-292
<b>Vacuum cleaners, ash separators &amp; accessories</b> Odkurzacze, separatory popiołu i akcesoria		283-284	<b>Plastic stools</b> Stołki plastikowe		292
<b>Syphon pumps</b> Pompy syfonowe		284-285	<b>Hooks &amp; furniture protection</b> Haczyki i zabezpieczenia		292-295
			<b>Hooks</b> Wieszaki		296
			<b>Cable organizers</b> Organizery do kabli		296-297

- PL Skrzynka na listy
- GB Mailbox
- D Briefkasten
- RUS Почтовый ящик
- CZ Schránka na dopisy
- RO Cutie poştală
- H Levélláda
- E Buzón



300x210x65 mm



No.	size / rozmiar (mm)	colour / kolor	
78550	300x210x65	●	12
78551	300x210x65	●	12
78552	300x210x65	●	12
78553	300x210x65	●	12

- PL Skrzynka na listy
- GB Mailbox
- D Briefkasten
- RUS Почтовый ящик
- CZ Schránka na dopisy
- RO Cutie poştală
- H Levélláda
- E Buzón



360x230x90 mm



No.	size / rozmiar (mm)	colour / kolor	
78560	360x230x90	●	10
78561	360x230x90	●	10
78562	360x230x90	●	10

- PL Skrzynka na listy
- GB Mailbox
- D Briefkasten
- RUS Почтовый ящик
- CZ Schránka na dopisy
- RO Cutie poştală
- H Levélláda
- E Buzón



310x360x100 mm



No.	size / rozmiar (mm)	colour / kolor	
78575	310x360x100	●	6
78576	310x360x100	●	6
78577	310x360x100	●	6

- PL Skrzynka na listy
- GB Mailbox
- D Briefkasten
- RUS Почтовый ящик
- CZ Schránka na dopisy
- RO Cutie poştală
- H Levélláda
- E Buzón



360x260x80 mm



No.	size / rozmiar (mm)	colour / kolor	
78555	360x260x80	●	6
78556	360x260x80	●	6
78557	360x260x80	●	6

- PL Skrzynka na listy
- GB Mailbox
- D Briefkasten
- RUS Почтовый ящик
- CZ Schránka na dopisy
- RO Cutie poştală
- H Levélláda
- E Buzón



400x250x100 mm



No.	size / rozmiar (mm)	colour / kolor	
78570	400x250x100	●	6
78571	400x250x100	●	6
78572	400x250x100	●	6

- PL Skrzynka na listy
- GB Mailbox
- D Briefkasten
- RUS Почтовый ящик
- CZ Schránka na dopisy
- RO Cutie poştală
- H Levélláda
- E Buzón



380x320x105 mm



No.	size / rozmiar (mm)	colour / kolor	
78580	380x320x105	●	5
78581	380x320x105	●	5
78582	380x320x105	●	5

PL Skrzynka na listy  
GB Mailbox  
D Briefkasten  
RUS Почтовый ящик  
CZ Schránka na dopisy  
RO Cutie poştală  
H Levélláda  
E Buzón

380x320x105  
mm

2x



**VOREL**

No.	size / rozmiar (mm)	colour / kolor	
78585	380x320x105	●	5
78586	380x320x105	●	5
78587	380x320x105	●	5

PL Piecyk węglowy  
GB Coal stove  
D Kohleofen  
RUS Угольная печь  
CZ Kamna na uhlí  
RO Soba  
H Szenes kályha  
E Calentador de carbón



No.	type / typ	kW	chamottes quantity / ilość szamotów	weight / waga (kg)	
72988	W3T	6	5	26	8

PL Piecyk węglowy  
GB Coal stove  
D Kohleofen  
RUS Угольная печь  
CZ Kamna na uhlí  
RO Soba  
H Szenes kályha  
E Calentador de carbón



No.	type / typ	kW	chamottes quantity / ilość szamotów	weight / waga (kg)	
72990	W4T	6	7	27	8

PL Skrzynka na listy  
GB Mailbox  
D Briefkasten  
RUS Почтовый ящик

CZ Schránka na dopisy  
RO Cutie poştală  
H Levélláda  
E Buzón

480x280x80  
mm

2x



**VOREL**

No.	size / rozmiar (mm)	colour / kolor	
78590	480x280x80	●	5
78591	480x280x80	●	5
78592	480x280x80	●	5

PL Piecyk węglowy  
GB Coal stove  
D Kohleofen  
RUS Угольная печь  
CZ Kamna na uhlí  
RO Soba  
H Szenes kályha  
E Calentador de carbón



No.	type / typ	kW	chamottes quantity / ilość szamotów	weight / waga (kg)	
72989	W2T	5	3	19	8

PL Piec grzewczy  
GB Heating stove  
D Heizofen  
RUS Печное отопление

CZ Vytápění kamna  
RO Sobă de încălzire  
H Kályha  
E Estufa de calefacción



**VOREL**

No.	type / typ	kW	weight / waga (kg)	
73002	SZW6G	6	51	4

PL Piec grzewczy  
GB Heating stove  
D Heizofen  
RUS Печное отопление

CZ Vytápění kamna  
RO Sobă de încălzire  
H Kályha  
E Estufa de calefacción



No.	type / typ	kW	weight / waga (kg)	
73003	SZW6T	6	51	4

PL Piec grzewczy  
GB Heating stove  
D Heizofen  
RUS Печное отопление

CZ Vytápění kamna  
RO Sobă de încălzire  
H Kályha  
E Estufa de calefacción



No.	type / typ	kW	weight / waga (kg)	
73005	SZW5T	5	47	8

PL Blacha przypieczowa ocynkowana  
GB Galvanized stove metal plate  
D Brenblech, verzinkt  
RUS Оцинкованный лист для обшивки печи  
CZ Podložka pod pec z pozinkovaného plechu  
RO Tablă sobă zincat  
H Galvanizált hő terelő lemez kályhához  
E Chapa galvanizada para estufa



No.	size / rozmiar (mm)	thickness / grubość (mm)	
72933	305x475	0.5	10
72934	396x600	0.5	10
72935	485x663	0.5	10

PL Piec grzewczy  
GB Heating stove  
D Heizofen  
RUS Печное отопление

CZ Vytápění kamna  
RO Sobă de încălzire  
H Kályha  
E Estufa de calefacción



No.	type / typ	kW	weight / waga (kg)	
73004	W5T	5	49	8

PL Piec grzewczy  
GB Heating stove  
D Heizofen  
RUS Печное отопление

CZ Vytápění kamna  
RO Sobă de încălzire  
H Kályha  
E Estufa de calefacción



No.	type / typ	kW	weight / waga (kg)	
73006	SZP5G	8	61	4

PL Blacha przypieczowa malowana  
GB Painted stove metal plate  
D Brenblech, mit Farbanstrich  
RUS Оцинкованный окрашенный лист для обшивки печи  
CZ Podložka pod pec z lakovaného plechu  
RO Tablă sobă vopsită  
H Festett hő terelő lemez kályhához  
E Chapa pintada para estufa



No.	size / rozmiar (mm)	thickness / grubość (mm)	
72936	476x603	0.5	10
72937	476x800	0.5	10

PL Wycior kominowy  
GB Chimney cleaner  
D Schornsteinreiniger  
RUS Щетка для трубочистов  
CZ Kartáč kominový  
RO Racletă pt. coșul de fum  
H Kéménytisztító kefe  
E Arilla para baquetas de calefacción central

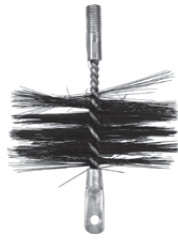

No.	Ø (mm)	
72948	120	15
72950	150	20
72951	175	18
72952	200	18

PL Wycior kominowy  
GB Chimney cleaner  
D Schornsteinreiniger  
RUS Щетка для трубочистов

CZ Kartáč kominový  
RO Racletă pt. coșul de fum  
H Kéménytisztító kefe  
E Arilla para baquetas de calefacción central



**VOREL**

No.	Ø (mm)	
72994	120	15
72995	150	20
72996	175	18
72997	200	18
72998	250	12

PL Pręt do wyciorów  
GB Central heating cleaning rod  
D Stab für die Reiner der Zentralheizung  
RUS Черенок для щеток – центральное отопление  
CZ Tyč k čištění  
RO Tije pt. racleji încălzire centrală  
H CO pálcza a füstcsőtisztító keféhez  
E Baqueta para limpiar el sistema de calefacción central



No.	Ø (mm)	L (mm)	
72956	7	600	50
72958	7	800	50
72960	7	1000	50

PL Wycior do C.O.  
GB Chimney cleaner  
D Schornsteinreiniger  
RUS Щетка для трубочистов

CZ Kartáč kominový  
RO Racletă pt. coșul de fum  
H Kéménytisztító kefe  
E Arilla para baquetas de calefacción central

No.	Ø (mm)	
72963	30	50
72964	40	50
72965	50	50
72966	60	35
72967	70	35
72968	80	30
72969	90	20
72970	100	20

PL Wycior kominowy  
GB Chimney cleaner  
D Schornsteinreiniger  
RUS Щетка для трубочистов

CZ Kartáč kominový  
RO Racletă pt. coșul de fum  
H Kéménytisztító kefe  
E Arilla para baquetas de calefacción central



**VOREL**

No.	Ø (mm)	
72953	250	12
72954	300	8

PL Kula kominarska  
GB Chimneysweep ball  
D Schornsteinfegerkugel  
RUS Гиря для трубочистов

CZ Kaminkrčcio kamuols  
RO Bilă pt. coșul de fum  
H Kémény golyó  
E Esfera del deholinador



No.		
72938	K15	4
72939	K25	4

PL Drut kominowy  
GB Chimney wire  
D Schornsteindraht  
RUS Проволока для трубочистов

CZ Kaminkrčcio trosas  
RO Sărmă pt. coșul de fum  
H Kéménytisztító drót  
E Alambre de chimeneas



No.	Ø (mm)	L (m)	
72942	3.5	6	25
72943	3.5	8	20
72944	3.5	10	20
72945	3.5	12	20



PL Szufelka angielska CZ Lopatka  
 GB Shovel RO Lopățică  
 D Schaufel H Lapát  
 RUS Совок E Pala



No.	mm	
72974	340x200	18

PL Szufelka gospodarcza CZ Lopatka  
 GB Shovel RO Lopățică  
 D Schaufel H Lapát  
 RUS Совок E Pala



**VOREL**

No.	mm	
72976	380x220	20

PL Szufelka szeroka CZ Lopatka  
 GB Shovel RO Lopățică  
 D Schaufel H Lapát  
 RUS Совок E Pala



No.	mm	
72975	460x220	40

PL Węglarka duża CZ Uhlák  
 GB Coal carrier RO Rezervor de cărbuni pt. sobă  
 D Kohlenkasten H Szeneskosár  
 RUS Ведро для угля E Carbonera



No.	L (mm)	W (mm)	H (mm)	
72984	420	230	205	5

PL Pogrzebacz CZ Pohrabáč  
 GB Poker RO Vătrai  
 D Schüreisen H Piszkavas  
 RUS Копрепа E Hurgón



No.	L (mm)	
72981	620	50

PL Szufelka CZ Lopatka  
 GB Shovel RO Lopățică  
 D Schaufel H Lapát  
 RUS Совок E Pala



No.	mm	
72977	550x180	30
72978	490x140	40

PL Szufelka mala CZ Lopatka  
 GB Shovel RO Lopățică  
 D Schaufel H Lapát  
 RUS Совок E Pala



No.	mm	
72979	500x110	5/30

PL Węglarka mala CZ Uhlák  
 GB Coal carrier RO Rezervor de cărbuni pt. sobă  
 D Kohlenkasten H Szeneskosár  
 RUS Ведро для угля E Carbonera



No.	L (mm)	W (mm)	H (mm)	
72985	340	200	175	5



PL Miotła  
GB Broom  
D Strassenbesen  
RUS Метла

CZ Metla  
RO Matura  
H Partvis  
E Cepillo pelo largo



No.	mm	
35867	300x65	10
35868	400x65	10

PL Miotła  
GB Broom  
D Strassenbesen  
RUS Метла

CZ Metla  
RO Matura  
H Partvis  
E Cepillo pelo largo



No.	L (mm)	
35870	300	10
35872	400	10
35874	500	10
35875	600	10
35876	800	10
35877	1000	10

PL Miotła drucziana do bruku  
GB Broom  
D Strassenbesen  
RUS Метла

CZ Metla  
RO Matura  
H Partvis  
E Cepillo pelo largo



**VOREL**

No.	L (mm)	
35923	300x55	6
35924	400x55	6

PL Miotła  
GB Broom  
D Strassenbesen  
RUS Метла

CZ Metla  
RO Matura  
H Partvis  
E Cepillo pelo largo



**FLO**

No.	L (mm)	
35912	1200x22	15

PL Miotła  
GB Broom  
D Strassenbesen  
RUS Метла

CZ Metla  
RO Matura  
H Partvis  
E Cepillo pelo largo



No.	
35869	10

PL Miotła  
GB Broom  
D Strassenbesen  
RUS Метла

CZ Metla  
RO Matura  
H Partvis  
E Cepillo pelo largo



No.	L (mm)	
35914	400x55	10
35915	500x55	10
35916	600x55	10
35918	800x55	10

PL Miotła  
GB Broom  
D Strassenbesen  
RUS Метла

CZ Metla  
RO Matura  
H Partvis  
E Cepillo pelo largo



No.	L (mm)	
35911	1150x22	140

PL Miotła  
GB Broom  
D Strassenbesen  
RUS Метла

CZ Metla  
RO Matura  
H Partvis  
E Cepillo pelo largo



No.	L (mm)	
35893	300	12
35894	400	12
35895	500	12

PL Miotta  
GB Broom  
D Strassenbesen  
RUS Метла

CZ Metla  
RO Matura  
H Partvis  
E Cepillo pelo largo



No.	L (mm)	
35899	250	12

PL Miotta  
GB Broom  
D Strassenbesen  
RUS Метла

CZ Metla  
RO Matura  
H Partvis  
E Cepillo pelo largo



No.	bristle length / długość włosia (mm)	
35906	135	12

PL Zgarniacz do wody  
GB Mop  
D Wasserschieber  
RUS Сгон для уборки воды

CZ Stěrka s gumou  
RO Mop cauciuc  
H Vízlehúzó gumi  
E Recogedor de agua universal



No.	L (mm)	
04561	330	120
04562	430	12/96

PL Łopata do śniegu  
GB Plastic shovel for snow  
D Kunststoff-schneeschaufel  
RUS Лопата снеговая

CZ Lopata na sněh  
RO Lopată pt. zăpadă  
H Műanyag hólapát  
E Pala para nieve



No.	mm	
35881	330x390	270

PL Miotta  
GB Broom  
D Strassenbesen  
RUS Метла

CZ Metla  
RO Matura  
H Partvis  
E Cepillo pelo largo



No.	bristle length / długość włosia (mm)	
35905	275	12

PL Miotta  
GB Broom  
D Strassenbesen  
RUS Метла

CZ Metla  
RO Matura  
H Partvis  
E Cepillo pelo largo



No.	bristle length / długość włosia (mm)	
35908	210	8

PL Łopata do śniegu  
GB Plastic shovel for snow  
D Kunststoff-schneeschaufel  
RUS Лопата снеговая

CZ Lopata na sněh  
RO Lopată pt. zăpadă  
H Műanyag hólapát  
E Pala para nieve



No.		
35880		180

PL Łopata do śniegu  
GB Plastic shovel for snow  
D Kunststoff-schneeschaufel  
RUS Лопата снеговая

CZ Lopata na sněh  
RO Lopată pt. zăpadă  
H Műanyag hólapát  
E Pala para nieve



No.	mm	
35889	400x430	180

PL Skuwacz do lodu  
GB Ice breaker  
D Eishammer  
RUS Прибор для скрывания льда

CZ Skováč na led  
RO Spărgător pt. gheață  
H Jégütő  
E Rompehielo mango



**VOREL**

No.	l	pcs packing	μm	☐
35878		125		

PL Worki na odpady, mocne  
GB Waste bags  
D Müllbeutel  
RUS Пакеты для мусора

CZ Pytle na odpad  
RO Saci gunoi  
H Szemeteszák  
E Bolsas para desperdicios



**VOREL**

No.	l	pcs packing	μm	☐
09465	120	10	30	25
09466	160	10	40	15
09467	240	10	40	10

PL Worki ogrodowe  
GB Garden bags  
D Gartensäcke  
RUS Мешки для огорода

CZ Zahradní pytle  
RO Saci gunoi pt. gradina  
H Kerti szemeteszák  
E Bolsas de jardín



**FLO**

No.	l	pcs packing	μm	☐
09481	120	10	60	15

PL Worki na odpady domowe  
GB Waste bags  
D Müllbeutel  
RUS Пакеты для мусора

CZ Pytle na odpad  
RO Saci gunoi  
H Szemeteszák  
E Bolsas para desperdicios



**VOREL**

No.	l	pcs packing	μm	material / material	☐
09486	35	50	6	HDPE	40
09487	35	30	11	MDPE	45
09489	60	20	13	MDPE	45

PL Worki na gruz, mocne  
GB Debris bags  
D Müllsäcke stabil  
RUS Мешки для щебня

CZ Pytle na sut  
RO Saci pt. demolari  
H Sittes zsák  
E Bolsas para escombros



**VOREL**

No.	l	pcs packing	μm	☐
09475	80	10	142	10
09476	80	3	142	10
09477	120	10	142	10
09478	120	3	142	10

PL Worki na odpady, budowlane  
GB Construction waste bags  
D Müllsäcke  
RUS Мешки для строительного мусора

CZ Pytle na stavební odpad  
RO Saci gunoi pt. santier  
H Zsák építési törmelékhez  
E Bolsas para desperdicios de construcción



**VOREL**

No.	l	pcs packing	μm	☐
09470	80	10	40	30
09471	120	15	60	10

PL Worki ogrodowe z taśmą  
GB Garden bags with cord  
D Gartensäcke mit Band  
RUS Мешки для огорода с лентой

CZ Zahradní pytle zatahovací  
RO Saci gunoi pt. gradina cu strangere  
H Szalagos kerti szemeteszák  
E Bolsas de jardín con cinta



**FLO**

No.	l	pcs packing	μm	☐
09480	60	10	60	12
09482	120	10	60	15

PL Worki na odpady domowe z taśmą  
GB Waste bags with cord  
D Müllbeutel mit Band  
RUS Пакеты для мусора с лентой

CZ Pytle na odpad  
RO Saci gunoi  
H Szemeteszák  
E Bolsas para desperdicios



**VOREL**

No.	l	pcs packing	μm	☐
09490	60	10	30	25

PL Worki na odpady z nadrukiem  
GB Waste bags  
D Müllbeutel  
RUS Пакеты для мусора

CZ Pytle na odpad  
RO Saci gunoi  
H Szemeteszsák  
E Bolsas para desperdicios



No.	l	pcs / packing	µm	
10000	60	15	30	30
10010	120	10	40	25

PL Worki na odpady z nadrukiem  
GB Waste bags  
D Müllbeutel  
RUS Пакеты для мусора

CZ Pytle na odpad  
RO Saci gunoi  
H Szemeteszsák  
E Bolsas para desperdicios



No.	l	pcs / packing	µm	
10002	60	15	30	30
10012	120	10	40	25

PL Worki na odpady z nadrukiem  
GB Waste bags  
D Müllbeutel  
RUS Пакеты для мусора

CZ Pytle na odpad  
RO Saci gunoi  
H Szemeteszsák  
E Bolsas para desperdicios



No.	l	pcs / packing	µm	
10004	60	15	30	30
10014	120	10	40	25

PL Plandeka  
GB Tarpaulin  
D Plane  
RUS Тент

CZ Plachta  
RO Husă  
H Ponyva  
E Toldo

No.	m	g/m2	
85122	2x3	57	30
85123	3x5	57	20
85124	4x5	57	10
85125	4x6	57	8
85126	5x8	57	5
85128	6x10	57	3
85129	8x12	57	2
85130	10x15	57	2

PL Worki na odpady z nadrukiem  
GB Waste bags  
D Müllbeutel  
RUS Пакеты для мусора

CZ Pytle na odpad  
RO Saci gunoi  
H Szemeteszsák  
E Bolsas para desperdicios



No.	l	pcs / packing	µm	
10001	60	15	30	30
10011	120	10	40	25

PL Worki na odpady z nadrukiem  
GB Waste bags  
D Müllbeutel  
RUS Пакеты для мусора

CZ Pytle na odpad  
RO Saci gunoi  
H Szemeteszsák  
E Bolsas para desperdicios



No.	l	pcs / packing	µm	
10013	120	10	40	25

PL Worki na odpady z nadrukiem  
GB Waste bags  
D Müllbeutel  
RUS Пакеты для мусора

CZ Pytle na odpad  
RO Saci gunoi  
H Szemeteszsák  
E Bolsas para desperdicios



No.	l	pcs / packing	µm	
10015	120	10	40	25

57 g/m<sup>2</sup>



PL Plandeka  
GB Tarpaulin  
D Plane  
RUS Тент

CZ Plachta  
RO Husă  
H PONYVA  
E Toldo

75 g/m<sup>2</sup>



No.	m	g/m <sup>2</sup>	☐
85112	2x3	75	30
85113	3x5	75	10
85114	4x5	75	10
85115	4x6	75	8
85116	5x8	75	5
85118	6x10	75	3
85119	8x12	75	2
85120	10x15	75	2

PL Separator do popiołu  
GB Ash separator  
D Ascheabscheider  
RUS Пелла сепаратор  
CZ Odličovač popela  
RO Filtru pt. cenușă  
H Hamuporszívó  
E Separador de ceniza

181 3-4 cm  
FIREPROOF HOSE / ZARÓPOPNY WĄZ  
FOR GRILL & FIREPLACE DO GRILLA I KOMINKA

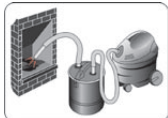

FOR USE WITH VACUUM CLEANER / DO ZASTOSOWANIA Z ODKURZACZEM



ALUMINIUM SUCTION NOZZLE / ALUMINIOWA KONCÓWKA

No.	☐
72920	1

PL Odkurzacz do popiołu  
GB Ash cleaner  
D Aschesauger  
RUS Пылесос для золы

CZ Vysavač popela  
RO Aspirator pt. cenușă  
H Hamuporszívó  
E Aspirador de cenizas

230V~50Hz 800 W 20l

16 kPa FOR GRILL & FIREPLACE DO GRILLA I KOMINKA

BLOW FUNCTION / FUNKCJA DMUCHAWY FIREPROOF HOSE / ZARÓPOPNY WĄZ



BLOW FUNCTION / FUNKCJA DMUCHAWY



STAINLESS STEEL TANK / POJEMNIK ZE STALI NIERDZEWNEJ



ALUMINIUM SUCTION NOZZLE / ALUMINIOWA KONCÓWKA



No.	W	☐
78870	800	1

PL Plandeka  
GB Tarpaulin  
D Plane  
RUS Тент

CZ Plachta  
RO Husă  
H PONYVA  
E Toldo

90 g/m<sup>2</sup>



VOREL

No.	m	g/m <sup>2</sup>	☐
85020	2x3	90	30
85030	3x5	90	18
85040	4x5	90	9
85050	4x6	90	10
85060	5x8	90	5
85080	6x10	90	4
85090	8x12	90	2
85100	10x15	90	1

PL Odkurzacz do popiołu  
GB Ash cleaner  
D Aschesauger  
RUS Пылесос для золы  
CZ Vysavač popela  
RO Aspirator pt. cenușă  
H Hamuporszívó  
E Aspirador de cenizas

230V~50Hz 800 W 18l

14 kPa FOR GRILL & FIREPLACE DO GRILLA I KOMINKA

BLOW FUNCTION / FUNKCJA DMUCHAWY FIREPROOF HOSE / ZARÓPOPNY WĄZ



BLOW FUNCTION / FUNKCJA DMUCHAWY



ALUMINIUM SUCTION NOZZLE / ALUMINIOWA KONCÓWKA



No.	W	☐
72928	800	1

PL Odkurzacz przemysłowy  
GB Industrial vacuum cleaner  
D Industriesauger  
RUS Пылесос промышленный

CZ Průmyslový vysavač  
RO Aspirator industrial  
H Ipați porszívó  
E Aspirador industria

230V~50Hz 1000 W 20l

17 kPa IP24

BLOW FUNCTION / FUNKCJA DMUCHAWY WET AND DRY / SUCHO MOKRO



DRY CLEANING / CZYSZCZENIE NA SUCHO



EASY STORAGE / LATWE PRZECHOWYWANIE



WET CLEANING / CZYSZCZENIE NA MOKRO



BLOW FUNCTION / FUNKCJA DMUCHAWY



CREVICE NOZZLE / KONCÓWKA SZCZELINOWA



No.	W	☐
78871	1000	1

PL Odkurzacz przemysłowy  
GB Industrial vacuum cleaner  
D Industriesauger  
RUS Пылесос промышленный

CZ Průmyslový vysavač  
RO Aspirator industrial  
H Ipari porszívó  
E Aspirador industria

230V~50Hz

1600 W

30 l

16 kPa

IPX4

POWER SOCKET  
Gniazdo do zasilania  
ZASILAJĄCE

WET AND DRY  
SUCHO MOKRO

BLOW FUNCTION  
Funkcja dmuchawy



**STHOR**

No.	W	
78873	1600	1

PL Filtr z korpusem  
GB Pet filter and plastic filter  
D Filter mit Gehäuse/Устройство для  
RUS Фильтр с корпусом

CZ Filtr s tělesem  
RO Filtru cu carcasa  
H Szűrő házzal  
E Filtro con el armazón

FOR/DLA  
72920



**VOREL**

No.	for / dla	
72921	72920	64

PL Wąż metalowy  
GB Metal hose  
D Metallschlauch  
RUS Металлический шланг

CZ Kovová hadice  
RO Furtun metalic  
H Hajlékony, fém tömlő  
E Manguera de metal

FOR/DLA  
72920

1m

ZINC STEEL  
STAL  
CYNKOWA

3.8cm



**VOREL**

No.	for / dla	
72922	72920	20

PL Pompa syfonowa  
GB Syphon pump  
D Siphon-pumpe  
RUS Сифонный насос

CZ Pumpa syfonová  
RO Pompa manuala pt. combustibil  
H Szifon pumpa  
E Bomba de sifon

**VOREL**

No.		
78020		30/60

PL Odkurzacz samochodowy  
GB Car vacuum cleaner  
D Handsauger  
RUS Ручной пылесос для автомобиля

CZ Vysavač do auta  
RO Aspirator de masina  
H Autó porszívó  
E Aspirador para coche

100 W

12 V

WET AND DRY  
SUCHO MOKRO

BAGLESS  
BEZWORKOWY

CYCLONIC  
CYKLONICZNY



**STHOR**

No.	W	V	
82951	100	12	8

PL Filtr  
GB Filter  
D Filter  
RUS Фильтр

CZ Filtr  
RO Filtru  
H Szűrő  
E Filtro

FOR/DLA  
72930



**VOREL**

No.	for / dla	
72931	72930; 78870	24

PL Wąż metalowy  
GB Metal hose  
D Metallschlauch  
RUS Металлический шланг

CZ Kovová hadice  
RO Furtun metalic  
H Hajlékony, fém tömlő  
E Manguera de metal

FOR/DLA  
72930

1m

3.8cm

Al  
23cm



**VOREL**

No.	for / dla	
72932	72930	24



6.2 l/min

14x390mm

12x540mm

5-50 °C

PL Pompa syfonowa  
GB Siphon pump  
D Siphon-pumpe  
RUS Сифонный насос

CZ Pumpa syfonová  
RO Pompa manuala pt. combustibil  
H Szifon-pumpa  
E Bomba de sífon



**VOREL**

No.	Box
78021	24

PL Pistolet do udrażniania rur  
GB Drain cleaner  
D Pistole zum Reinigen von Röhren  
RUS Пистолет для прочистки труб  
CZ Pistole na čišťení trubek  
RO Pistol pt. curățarea țevilor  
H Csőtisztító pisztoly  
E Pistola des tapacaños



**VOREL**

No.	Ø (mm)	Box
55500	135	10

PL Przepychacz do udrażniania kanalizacji  
GB Pipe cleaner  
D Räumdom zum Reinigen der Kanalisation  
RUS Поршень для прочистки канализации

CZ Tlakový čistič kanalizace  
RO Piston pt. deblocarea canalizării  
H Lefolyótisztító pumpa  
E Bomba des tapacaños



**VOREL**

No.	L (cm)	pcs	Box
55531	65	2	36

PL Spirala kanalizacyjna  
GB Drain auger  
D Hand-Rohrreinigungsspirale  
RUS Трос сантехнический пружинный

CZ Spirála kanalizační  
RO Dispozitiv de desfundat scurgere  
H Csőtisztító spirál  
E Desatascador espiral



**VOREL**

No.	Ø (mm)	L (m)	Box
55544	9	5	5/10
55545	9	10	4/8

PL Pompka wielofunkcyjna  
GB Multi-purpose pump  
D Multifunktionale Pumpe  
RUS Многофункциональный насос

CZ Univerzální pumpička  
RO Pompă multifuncțională  
H Többfunkciós szivattyú  
E Bomba multiusos



**VOREL**

No.	Box
78022	6/24

PL Pompa do udrażniania kanalizacji  
GB Drain suction pump  
D Hochdruck-Rohreiniger  
RUS Ручной насос для прочистки труб

CZ Čerpadlo na čišťení trubek  
RO Pompă pt. curățarea țevilor  
H Csőtisztító szivattyú  
E El desague del fregadero limpiador



**VOREL**

No.	Ø (mm)	Box
55505	65; 155	24

PL Spirala kanalizacyjna  
GB Drain auger  
D Hand-Rohrreinigungsspirale  
RUS Трос сантехнический пружинный

CZ Spirála kanalizační  
RO Dispozitiv de desfundat scurgere  
H Csőtisztító spirál  
E Desatascador espiral



**VOREL**

No.	Ø (mm)	L (m)	Box
55541	5	1.5	20/80
55542	6	3	18/36

PL Wazelina techniczna  
GB Vaseline  
D Vaseline  
RUS Вазелин технический

CZ Technická vazelina  
RO Vaselină tehnică  
H Műszaki vazelin  
E Vaselina tecnica



**VOREL**

No.	ml	Box
86700	50	50
86701	100	50

- PL Składany wózek magazynowy
- GB Foldable hand truck
- D Klappbare Transportkarre
- RUS Складная тележка
- CZ Skládaci hliníkový rudi
- RO Carucior cu manere pliabil
- H Öszecsukható kézikocsi
- E Carretilla de mano plegable

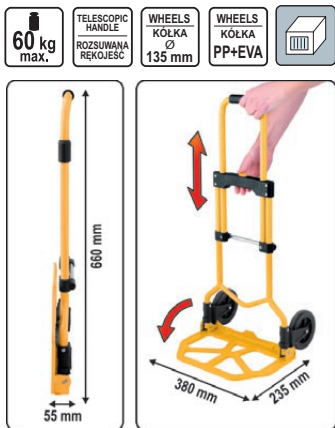

No.	max. capacity / max. ładowność (kg)	
78660	60	1

- PL Kółko stałe
- GB Fixed caster
- D Bockrolle
- RUS Ролик с стационарной опорой
- CZ Pevné kolečko
- RO Roata de carucior fixa
- H Szállítógörgők
- E Rueda fija



TEMPERATURE TOLERANCE  
ODPORNOŚĆ NA TEMPERATURĘ  
-10°C ÷ +50°C

RUBBER  
GUMA

ROLLER BEARING  
ŁOŻYSKO WALECZKOWE



No.	wheel diameter / średnica kółka (mm)	wheel width / szerokość kółka (mm)	caster height / wysokość kółka (mm)	load capacity / obciążalność (kg)	
87301	75	23	97	40	60
87302	100	27	130	60	32
87303	125	34	155	100	22
87305	160	40	195	130	10
87307	200	46	235	150	8

- PL Kółko skrętne z czarną gumą
- GB Swivel caster
- D Lenkrolle mit Feststeller
- RUS Ролик с вращающейся опорой
- CZ Otočné kolečko
- RO Roata de carucior mobila
- H Szállítógörgők
- E Rueda giratoria con freno



TEMPERATURE TOLERANCE  
ODPORNOŚĆ NA TEMPERATURĘ  
-10°C ÷ +50°C

RUBBER  
GUMA

DOUBLE BRAKE  
PODWÓJNY HAMULEC

ROLLER BEARING  
ŁOŻYSKO WALECZKOWE



No.	wheel diameter / średnica kółka (mm)	wheel width / szerokość kółka (mm)	caster height / wysokość kółka (mm)	load capacity / obciążalność (kg)	
87321	75	23	97	40	40
87322	100	27	130	60	20
87323	125	34	155	100	16
87325	160	40	195	130	8
87327	200	46	235	150	6

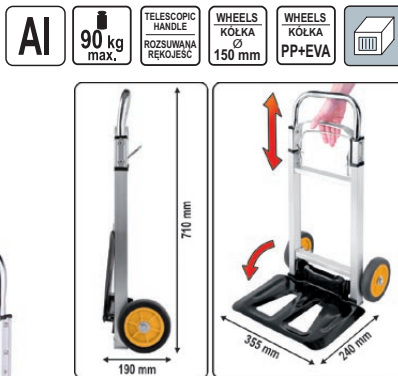

No.	max. capacity / max. ładowność (kg)	
78661	90	1

- PL Kółko skrętne z czarną gumą
- GB Swivel caster
- D Lenkrolle mit Feststeller
- RUS Ролик с вращающейся опорой
- CZ Otočné kolečko
- RO Roata de carucior mobila
- H Szállítógörgők
- E Rueda giratoria con freno



TEMPERATURE TOLERANCE  
ODPORNOŚĆ NA TEMPERATURĘ  
-10°C ÷ +50°C

RUBBER  
GUMA

ROLLER BEARING  
ŁOŻYSKO WALECZKOWE



No.	wheel diameter / średnica kółka (mm)	wheel width / szerokość kółka (mm)	caster height / wysokość kółka (mm)	load capacity / obciążalność (kg)	
87311	75	23	97	40	48
87312	100	27	130	60	26
87313	125	34	155	100	20
87315	160	40	195	130	10
87317	200	46	235	150	6

- PL Kółko skrętne z czarną gumą
- GB Swivel caster
- D Lenkrolle mit Feststeller
- RUS Ролик с вращающейся опорой
- CZ Otočné kolečko
- RO Roata de carucior mobila
- H Szállítógörgők
- E Rueda giratoria con freno



TEMPERATURE TOLERANCE  
ODPORNOŚĆ NA TEMPERATURĘ  
-10°C ÷ +50°C

RUBBER  
GUMA

DOUBLE BRAKE  
PODWÓJNY HAMULEC

ROLLER BEARING  
ŁOŻYSKO WALECZKOWE

THREADED STEM  
TRZPIEN ŚWITOWANY



No.	wheel diameter / średnica kółka (mm)	wheel width / szerokość kółka (mm)	caster height / wysokość kółka (mm)	load capacity / obciążalność (kg)	
87331	75	22	97	40	38
87332	100	26	130	60	24
87333	125	33	153	100	18
87335	160	39	190	130	8
87337	200	44	230	150	6



PL Kółko skrętne z szarą gumą  
GB Swivel caster  
D Lenkrolle mit Feststeller  
RUS Ролик с вращающийся опорой  
CZ Otočné kolečko  
RO Roata de carucior mobila  
H Szállítógörgők  
E Rueda giratoria con freno



TEMPERATURE TOLERANCE  
ODPORNOŚĆ NA TEMPERATURĘ  
-10°C ÷ +50°C

RUBBER  
GUMA

PLAIN BEARING  
ŁOŻYSKO ŚLIZGOWE

**VOREL**

No.	wheel diameter / średnica kółka (mm)	wheel width / szerokość kółka (mm)	caster height / wysokość kółka (mm)	load capacity / obciążalność (kg)	
87351	50	16	72	20	140
87352	75	21	104	30	60
87353	100	26	134	45	38
87354	125	27	161	50	25

PL Kółko skrętne z szarą gumą  
GB Swivel caster  
D Lenkrolle mit Feststeller  
RUS Ролик с вращающийся опорой

CZ Otočné kolečko  
RO Roata de carucior mobila  
H Szállítógörgők  
E Rueda giratoria con freno



TEMPERATURE TOLERANCE  
ODPORNOŚĆ NA TEMPERATURĘ  
-10°C ÷ +50°C

RUBBER  
GUMA

BOLT HOLE  
OTWÓR MOCUJĄCY

PLAIN BEARING  
ŁOŻYSKO ŚLIZGOWE

**VOREL**

No.	wheel diameter / średnica kółka (mm)	wheel width / szerokość kółka (mm)	caster height / wysokość kółka (mm)	load capacity / obciążalność (kg)	
87371	50	16	70	20	120
87372	75	21	101	30	64
87373	100	26	132	45	34
87374	125	27	158	50	24

PL Kółko stałe  
GB Fixed caster  
D Bockrolle  
RUS Ролик с стационарной опорой

CZ Pevné kolečko  
RO Roata de carucior fixa  
H Szállítógörgők  
E Rueda fija



TEMPERATURE TOLERANCE  
ODPORNOŚĆ NA TEMPERATURĘ  
-10°C ÷ +50°C

POLYPROPYLENE  
POLIPROPYLEN

POM BEARING  
ŁOŻYSKO POM

**VOREL**

No.	wheel diameter / średnica kółka (mm)	wheel width / szerokość kółka (mm)	caster height / wysokość kółka (mm)	load capacity / obciążalność (kg)	
87391	40	17	54	20	280
87392	50	22	65	25	130
87393	65	23	84	30	90

PL Kółko skrętne  
GB Swivel caster  
D Bockrolle  
RUS Ролик с вращающийся опорой

CZ Otočné kolečko  
RO Roata de carucior mobila  
H Szállítógörgők  
E Rueda giratoria con freno



TEMPERATURE TOLERANCE  
ODPORNOŚĆ NA TEMPERATURĘ  
-10°C ÷ +50°C

POLYPROPYLENE  
POLIPROPYLEN

ROLLER BEARING  
ŁOŻYSKO WALECZKOWE

PLAIN BEARING  
ŁOŻYSKO ŚLIZGOWE

**VOREL**

No.	wheel diameter / średnica kółka (mm)	wheel width / szerokość kółka (mm)	caster height / wysokość kółka (mm)	load capacity / obciążalność (kg)	
87411	40	17	54	20	230
87412	50	22	65	25	110
87413	65	23	84	30	72

PL Kółko skrętne z szarą gumą  
GB Swivel caster  
D Lenkrolle mit Feststeller  
RUS Ролик с вращающийся опорой  
CZ Otočné kolečko  
RO Roata de carucior mobila  
H Szállítógörgők  
E Rueda giratoria con freno



TEMPERATURE TOLERANCE  
ODPORNOŚĆ NA TEMPERATURĘ  
-10°C ÷ +50°C

RUBBER  
GUMA

PLAIN BEARING  
ŁOŻYSKO ŚLIZGOWE

**VOREL**

No.	wheel diameter / średnica kółka (mm)	wheel width / szerokość kółka (mm)	caster height / wysokość kółka (mm)	load capacity / obciążalność (kg)	
87361	50	16	72	20	100
87362	75	21	104	30	52
87363	100	26	134	45	28
87364	125	27	161	50	24

PL Kółko skrętne z szarą gumą  
GB Swivel caster  
D Lenkrolle mit Feststeller  
RUS Ролик с вращающийся опорой

CZ Otočné kolečko  
RO Roata de carucior mobila  
H Szállítógörgők  
E Rueda giratoria con freno



TEMPERATURE TOLERANCE  
ODPORNOŚĆ NA TEMPERATURĘ  
-10°C ÷ +50°C

RUBBER  
GUMA

PLAIN BEARING  
ŁOŻYSKO ŚLIZGOWE

BRAKE  
HAMULEC

**VOREL**

No.	wheel diameter / średnica kółka (mm)	wheel width / szerokość kółka (mm)	caster height / wysokość kółka (mm)	load capacity / obciążalność (kg)	
87381	50	16	72	20	96
87382	75	21	104	30	50
87383	100	26	134	45	26
87384	125	27	161	50	22

PL Kółko skrętne  
GB Swivel caster  
D Lenkrolle mit Feststeller  
RUS Ролик с вращающийся опорой

CZ Otočné kolečko  
RO Roata de carucior mobila  
H Szállítógörgők  
E Rueda giratoria con freno



TEMPERATURE TOLERANCE  
ODPORNOŚĆ NA TEMPERATURĘ  
-10°C ÷ +50°C

POLYPROPYLENE  
POLIPROPYLEN

POM BEARING  
ŁOŻYSKO POM

**VOREL**

No.	wheel diameter / średnica kółka (mm)	wheel width / szerokość kółka (mm)	caster height / wysokość kółka (mm)	load capacity / obciążalność (kg)	
87401	40	17	54	20	260
87402	50	22	65	25	120
87403	65	23	84	30	78

PL Kółko stałe  
GB Fixed caster  
D Bockrolle  
RUS Ролик с стационарной опорой

CZ Pevné kolečko  
RO Roata de carucior fixa  
H Szállítógörgők  
E Rueda fija



TEMPERATURE TOLERANCE  
ODPORNOŚĆ NA TEMPERATURĘ  
-15°C ÷ +80°C

POLYAMIDE  
POLIAMID

ROLLER BEARING  
ŁOŻYSKO WALECZKOWE

**VOREL**

No.	wheel diameter / średnica kółka (mm)	wheel width / szerokość kółka (mm)	caster height / wysokość kółka (mm)	load capacity / obciążalność (kg)	
87422	100	31	130	60	38
87423	125	33	155	100	28
87425	160	40	195	130	12
87427	200	40	235	150	8

PL Kółko skrętne  
GB Swivel caster  
D Lenkrolle mit Feststeller  
RUS Ролик с вращающийся опорой

CZ Otočné kolečko  
RO Roata de carucior mobila  
H Szállítógörgők  
E Rueda giratoria con freno

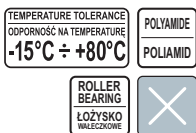

**VOREL**

No.	wheel diameter / średnica kółka (mm)	wheel width / szerokość kółka (mm)	caster height / wysokość kółka (mm)	load capacity / obciążalność (kg)	
87431	75	23	97	40	60
87432	100	31	130	60	32
87433	125	33	155	100	26
87435	160	40	195	130	12
87437	200	40	235	150	8

PL Kółko czarna guma  
GB Wheel  
D Transportrad  
RUS Ролик

CZ Kolečko  
RO Roata de carucior  
H Őnálló görgők  
E Rueda

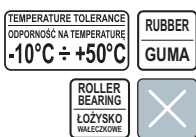

**VOREL**

No.	wheel diameter / średnica kółka (mm)	wheel width / szerokość kółka (mm)	axle / oś	load capacity / obciążalność (kg)	
87451	75	22	Ø12mm x 30mm	40	150
87452	100	26	Ø12mm x 40mm	60	66
87453	125	33	Ø15mm x 40mm	100	36
87454	150	39	Ø20mm x 55mm	110	22
87455	160	39	Ø20mm x 55mm	130	20
87456	200	44	Ø20/25mm x 55mm	150	12
87457	250	48	Ø20/25mm x 55mm	180	8

PL Uszczelka do okien i drzwi  
GB Seal for windows and doors  
D Dichtung für Fenster und Türen  
RUS Уплотнители для окон и дверей

CZ Těsnění oken a dveří  
RO Seal pt. ferestre si usi  
H Seal az ablakok és ajtók  
E Sellar para ventanas y puertas



**ANOK**

No.	dimensions / wymiary (mm)	L (m)	type / profil	colour / kolor	
76757	9x7.4	100	D		6
76767	9x7.4	100	D		6

PL Uszczelka do okien i drzwi  
GB Seal for windows and doors  
D Dichtung für Fenster und Türen  
RUS Уплотнители для окон и дверей

CZ Těsnění oken a dveří  
RO Seal pt. ferestre si usi  
H Seal az ablakok és ajtók  
E Sellar para ventanas y puertas

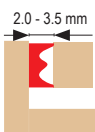

**ANOK**

No.	dimensions / wymiary (mm)	L (m)	type / profil	colour / kolor	
76755	9x4	150	E		6
76765	9x4	150	E		6

PL Kółko skrętne  
GB Swivel caster  
D Lenkrolle mit Feststeller  
RUS Ролик с вращающийся опорой

CZ Otočné kolečko  
RO Roata de carucior mobila  
H Szállítógörgők  
E Rueda giratoria con freno

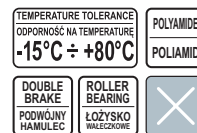

**VOREL**

No.	wheel diameter / średnica kółka (mm)	wheel width / szerokość kółka (mm)	caster height / wysokość kółka (mm)	load capacity / obciążalność (kg)	
87445	160	40	195	130	10
87447	200	40	235	150	8

PL Uszczelka do okien i drzwi  
GB Seal for windows and doors  
D Dichtung für Fenster und Türen  
RUS Уплотнители для окон и дверей

CZ Těsnění oken a dveří  
RO Seal pt. ferestre si usi  
H Seal az ablakok és ajtók  
E Sellar para ventanas y puertas

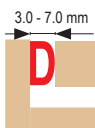

**ANOK**

No.	dimensions / wymiary (mm)	L (m)	type / profil	colour / kolor	
76752	9x7.4	6	D		24
76762	9x7.4	6	D		24

PL Uszczelka do okien i drzwi  
GB Seal for windows and doors  
D Dichtung für Fenster und Türen  
RUS Уплотнители для окон и дверей

CZ Těsnění oken a dveří  
RO Seal pt. ferestre si usi  
H Seal az ablakok és ajtók  
E Sellar para ventanas y puertas

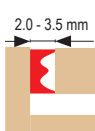

**ANOK**

No.	dimensions / wymiary (mm)	L (m)	type / profil	colour / kolor	
76750	9x4	6	E		24
76760	9x4	6	E		24

PL Uszczelka do okien i drzwi  
GB Seal for windows and doors  
D Dichtung für Fenster und Türen  
RUS Уплотнители для окон и дверей

CZ Těsnění oken a dveří  
RO Seal pt. ferestre si usi  
H Seal az ablakok és ajtók  
E Sellar para ventanas y puertas



**ANOK**

No.	dimensions / wymiary (mm)	L (m)	type / profil	colour / kolor	
76751	9x5.5	6	P		24
76761	9x5.5	6	P		24

PL Uszczelka do okien i drzwi  
GB Seal for windows and doors  
D Dichtung für Fenster und Türen  
RUS Уплотнители для окон и дверей

CZ Těsnění oken a dveří  
RO Seal pt. ferestre si usi  
H Seal az ablakok és ajtók  
E Sellar para ventanas y puertas



**SANOK**

No.	dimensions / wymary (mm)	L (m)	type / profil	colour / kolor	
76756	9x5.5	100	P		6
76766	9x5.5	100	P		6

PL Podkładka samoprzylepna, korkowa  
GB Self-adhesive pad for furniture  
D Klebegleiter für Möbel  
RUS Самоклеящая подкладка под мебель

CZ Podložka samolepící pod nábytek  
RO Adeziv pad sub mobilier  
H Őntapadó, bútorláb alátét  
E Arandela adhesiva bajo los muebles



**VOREL**

No.	mm	pcs	
74812	100x120	1	60/720

PL Podkładka samoprzylepna, antypoślizgowa  
GB Self-adhesive pad for furniture  
D Klebegleiter für Möbel  
RUS Самоклеящая подкладка под мебель

CZ Podložka samolepící pod nábytek  
RO Adeziv pad sub mobilier  
H Őntapadó, bútorláb alátét  
E Arandela adhesiva bajo los muebles



**VOREL**

No.	mm	pcs	
74828	100x120	1	60/720

PL Podkładka samoprzylepna z włókniny mix  
GB Self-adhesive pad for furniture  
D Klebegleiter für Möbel  
RUS Самоклеящая подкладка под мебель

CZ Podložka samolepící pod nábytek  
RO Adeziv pad sub mobilier  
H Őntapadó, bútorláb alátét  
E Arandela adhesiva bajo los muebles



**VOREL**

No.	Ø (mm)	pcs	
74838	20; 38	12	60/720

PL Podkładka samoprzylepna, korkowa  
GB Self-adhesive pad for furniture  
D Klebegleiter für Möbel  
RUS Самоклеящая подкладка под мебель

CZ Podložka samolepící pod nábytek  
RO Adeziv pad sub mobilier  
H Őntapadó, bútorláb alátét  
E Arandela adhesiva bajo los muebles



**VOREL**

No.	Ø (mm)	pcs	
74802	20	20	60/720
74804	28	12	60/720

PL Podkładka samoprzylepna, antypoślizgowa  
GB Self-adhesive pad for furniture  
D Klebegleiter für Möbel  
RUS Самоклеящая подкладка под мебель

CZ Podložka samolepící pod nábytek  
RO Adeziv pad sub mobilier  
H Őntapadó, bútorláb alátét  
E Arandela adhesiva bajo los muebles



**VOREL**

No.	Ø (mm)	pcs	
74816	10	24	60/720
74818	20	20	60/720
74820	28	12	60/720

PL Podkładka samoprzylepna z włókniny  
GB Self-adhesive pad for furniture  
D Klebegleiter für Möbel  
RUS Самоклеящая подкладка под мебель

CZ Podložka samolepící pod nábytek  
RO Adeziv pad sub mobilier  
H Őntapadó, bútorláb alátét  
E Arandela adhesiva bajo los muebles

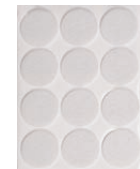

**VOREL**

No.	Ø (mm)	pcs	
74831	20	20	60/720
74833	28	12	60/720
74835	40	4	60/720

PL Podkładka samoprzylepna z włókniny  
GB Self-adhesive pad for furniture  
D Klebegleiter für Möbel  
RUS Самоклеящая подкладка под мебель

CZ Podložka samolepící pod nábytek  
RO Adeziv pad sub mobilier  
H Őntapadó, bútorláb alátét  
E Arandela adhesiva bajo los muebles



**VOREL**

No.	mm	pcs	
74841	20x20	20	60/720
74843	28x28	12	60/720

PL Podkładka samoprzylepna z włókniny  
GB Self-adhesive pad for furniture  
D Klebegleiter für Möbel  
RUS Самоклеящая подкладка под мебель

CZ Podložka samolepící pod nábytek  
RO Adeziv pad sub mobilier  
H Öntapadó, bútörláb alátét  
E Arandela adhesiva bajo los muebles

NONWOVEN  
WŁÓKNINA



**VOREL**

No.	mm	pcs	
74846	20x45	10	60/720

PL Podkładka samoprzylepna z włókniny mix  
GB Self-adhesive pad for furniture  
D Klebegleiter für Möbel  
RUS Самоклеящая подкладка под мебель

CZ Podložka samolepící pod nábytek  
RO Adeziv pad sub mobilier  
H Öntapadó, bútörláb alátét  
E Arandela adhesiva bajo los muebles

NONWOVEN  
WŁÓKNINA

MIX



**VOREL**

No.	Ø (mm)	pcs	
74858	20; 38	12	60/720

PL Podkładka samoprzylepna z włókniny  
GB Self-adhesive pad for furniture  
D Klebegleiter für Möbel  
RUS Самоклеящая подкладка под мебель

CZ Podložka samolepící pod nábytek  
RO Adeziv pad sub mobilier  
H Öntapadó, bútörláb alátét  
E Arandela adhesiva bajo los muebles

NONWOVEN  
WŁÓKNINA



**VOREL**

No.	Ø (mm)	pcs	
74851	20	20	60/720
74853	28	12	60/720
74855	40	4	60/720
74856	50	2	60/720

PL Podkładka samoprzylepna z włókniny  
GB Self-adhesive pad for furniture  
D Klebegleiter für Möbel  
RUS Самоклеящая подкладка под мебель

CZ Podložka samolepící pod nábytek  
RO Adeziv pad sub mobilier  
H Öntapadó, bútörláb alátét  
E Arandela adhesiva bajo los muebles

NONWOVEN  
WŁÓKNINA



**VOREL**

No.	mm	pcs	
74869	100x120	1	60/720

PL Podkładka samoprzylepna z włókniny  
GB Self-adhesive pad for furniture  
D Klebegleiter für Möbel  
RUS Самоклеящая подкладка под мебель

CZ Podložka samolepící pod nábytek  
RO Adeziv pad sub mobilier  
H Öntapadó, bútörláb alátét  
E Arandela adhesiva bajo los muebles

NONWOVEN  
WŁÓKNINA



**VOREL**

No.	mm	pcs	
74849	100x120	1	60/720

PL Podkładka samoprzylepna z włókniny  
GB Self-adhesive pad for furniture  
D Klebegleiter für Möbel  
RUS Самоклеящая подкладка под мебель

CZ Podložka samolepící pod nábytek  
RO Adeziv pad sub mobilier  
H Öntapadó, bútörláb alátét  
E Arandela adhesiva bajo los muebles

NONWOVEN  
WŁÓKNINA



**VOREL**

No.	mm	pcs	
74861	20x20	20	60/720
74863	28x28	12	60/720

PL Podkładka samoprzylepna z włókniny  
GB Self-adhesive pad for furniture  
D Klebegleiter für Möbel  
RUS Самоклеящая подкладка под мебель

CZ Podložka samolepící pod nábytek  
RO Adeziv pad sub mobilier  
H Öntapadó, bútörláb alátét  
E Arandela adhesiva bajo los muebles

NONWOVEN  
WŁÓKNINA

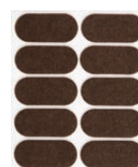

**VOREL**

No.	mm	pcs	
74866	20x45	10	60/720

PL Podkładka samoprzylepna, antypoślizgowa  
GB Self-adhesive pad for furniture  
D Klebegleiter für Möbel  
RUS Самоклеящая подкладка под мебель

CZ Podložka samolepící pod nábytek  
RO Adeziv pad sub mobilier  
H Öntapadó, bútörláb alátét  
E Arandela adhesiva bajo los muebles

NON-SLIP  
ANTI-POŚLIZGOWY

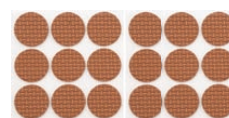

**VOREL**

No.	Ø (mm)	pcs	
74882	25	18	24/432
74883	38	8	24/432

**PL** Podkładka samoprzylepna, antypoślizgowa  
**GB** Self-adhesive pad for furniture  
**D** Klebegleiter für Möbel  
**RUS** Самоклеящая подкладка под мебель

**CZ** Podložka samolepící pod nábytek  
**RO** Adeziv pad sub mobilier  
**H** Őntapadó, bútorláb alátét  
**E** Arandela adhesiva bajo los muebles

NON-SLIP  
 ANTY-  
 POŚLIZGOWY



**VOREL**

No.	Ø (mm)	pcs	
74885	18	32	24/432
74886	25	18	24/432
74887	38	8	24/432

**PL** Podkładka samoprzylepna, antypoślizgowa  
**GB** Self-adhesive pad for furniture  
**D** Klebegleiter für Möbel  
**RUS** Самоклеящая подкладка под мебель

**CZ** Podložka samolepící pod nábytek  
**RO** Adeziv pad sub mobilier  
**H** Őntapadó, bútorláb alátét  
**E** Arandela adhesiva bajo los muebles

NON-SLIP  
 ANTY-  
 POŚLIZGOWY

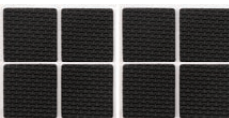

**VOREL**

No.	Ø (mm)	pcs	
74895	18x18	32	24/432
74896	25x25	18	24/432
74898	85x85	2	24/432

**PL** Podkładka samoprzylepna, silikonowa  
**GB** Self-adhesive silicone pad for furniture  
**D** Klebegleiter für Möbel  
**RUS** Самоклеящая подкладка под мебель

**CZ** Podložka samolepící pod nábytek  
**RO** Adeziv pad sub mobilier  
**H** Őntapadó, bútorláb alátét  
**E** Arandela adhesiva bajo los muebles

SILICONE  
 SILIKON



**VOREL**

No.	Ø (mm)	pcs	
74910	8	25	32/576
74911	10	20	32/576
74912	13	12	32/576
74913	15	9	32/576
74914	19	6	32/576

**PL** Podkładka samoprzylepna plastikowo-piankowa  
**GB** Self-adhesive plastic glides  
**D** Klebegleiter für Möbel  
**RUS** Самоклеящая подкладка под мебель

**CZ** Podložka samolepící pod nábytek  
**RO** Adeziv pad sub mobilier  
**H** Őntapadó, bútorláb alátét  
**E** Arandela adhesiva bajo los muebles

PLASTIC  
 PLASTIK



**VOREL**

No.	Ø (mm)	pcs	
74930	18	12	24/432
74932	28	4	24/432
74933	38	4	24/432

**PL** Podkładka samoprzylepna, antypoślizgowa  
**GB** Self-adhesive pad for furniture  
**D** Klebegleiter für Möbel  
**RUS** Самоклеящая подкладка под мебель

**CZ** Podložka samolepící pod nábytek  
**RO** Adeziv pad sub mobilier  
**H** Őntapadó, bútorláb alátét  
**E** Arandela adhesiva bajo los muebles

NON-SLIP  
 ANTY-  
 POŚLIZGOWY

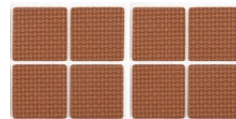

**VOREL**

No.	Ø (mm)	pcs	
74894	85x85	2	24/432

**PL** Podkładka samoprzylepna, antypoślizgowa  
**GB** Self-adhesive pad for furniture  
**D** Klebegleiter für Möbel  
**RUS** Самоклеящая подкладка под мебель

**CZ** Podložka samolepící pod nábytek  
**RO** Adeziv pad sub mobilier  
**H** Őntapadó, bútorláb alátét  
**E** Arandela adhesiva bajo los muebles

NON-SLIP  
 ANTY-  
 POŚLIZGOWY



**VOREL**

No.	Ø (mm)	pcs	
74904	85x85	2	24/432

**PL** Podkładki plastikowo-filcowe na gwóźdź  
**GB** Felt & plastic furniture glides  
**D** Kunststoff- und Filzgleiter zum Nageln  
**RUS** Подкладки пластиковые фильцевые на гвоздь  
**CZ** Plastové podložky s plstí na hřebík  
**RO** Şaibe din plastic-pâslă pt. cuiie  
**H** Műanyag-filc alátét szőghöz  
**E** Arandelas de plástico y fieltro con clave

FELT  
 PLASTIC  
 FILC  
 PLASTIK

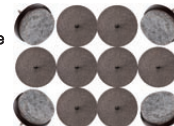

**VOREL**

No.	Ø (mm)	pcs	
74920	17	16	16/288
74921	20	12	16/288
74922	24	12	16/288
74923	28	8	16/256
74924	30	8	16/256

**PL** Podkładki plastikowe na gwóźdź  
**GB** Plastic furniture glides  
**D** Kunststoffgleiter zum Nageln  
**RUS** Подкладки пластиковые на гвоздь

**CZ** Plastové podložky na hřebík  
**RO** Şaibe din plastic pt. cuiie  
**H** Műanyag alátét szőghöz  
**E** Arandelas de plástico con clave

PLASTIC  
 PLASTIK

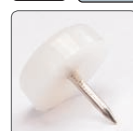

**VOREL**

No.	Ø (mm)	pcs	
74935	18	12	16/288
74936	20	12	16/288
74937	25	8	16/288

- PL Podkładki plastikowe na wkręt
- GB Plastic furniture glides
- D Kunststoffgleiter zum Anschrauben
- RUS Подкладки пластиковые на шуруп
- CZ Plastové podložky na vrut
- RO Șaibe din plastic pt. șurub
- H Műanyag alátét csavarhoz
- E Arandelas de plástico con tornillo



No.	Ø (mm)	pcs	
74941	26	4	24/432

- PL Kliny pod meble
- GB Levelling wedge
- D Keile für Möbel
- RUS Клинья под мебель
- CZ Kliny pod nábytek
- RO Pene pt. mobilă
- H Bütörék
- E Cuña para muebles



No.	pcs	
74960	4	16/288

- PL Stolek plastikowy
- GB Plastic stool
- D Kunststoff Hocker
- RUS Пластиковый табурет
- CZ Plastová stolička
- RO Scaun de plastic
- H Műanyag széklét
- E Taburete de plástico



No.	size / rozmiar (cm)	
75916	30x20x21	10/20

- PL Haczyki naścienne samoprzylepne
- GB Self-adhesive hanging hooks
- D Selbstklebende Wandhaken
- RUS Крючки настенные на липучках
- CZ Háčky nástěnné samolepící
- RO Cârige perete autocolante
- H Műanyag, fali kampó, öntapadós
- E Ganchos adhesivos para pared



No.	max (kg)	pcs	
74732	1.0	3	16/192

- PL Podkładki plastikowe na wkręt
- GB Plastic furniture glides
- D Kunststoffgleiter zum Anschrauben
- RUS Подкладки пластиковые на шуруп

- CZ Plastové podložky na vrut
- RO Șaibe din plastic pt. șurub
- H Műanyag alátét csavarhoz
- E Arandelas de plástico con tornillo



No.	Ø (mm)	pcs	
74944	20	8	24/432
74945	26	4	24/432

- PL Stolek plastikowy
- GB Plastic stool
- D Kunststoff Hocker
- RUS Пластиковый табурет
- CZ Plastová stolička
- RO Scaun de plastic
- H Műanyag széklét
- E Taburete de plástico



No.	size / rozmiar (cm)	
75915	30x20x21	10/20

- PL Haczyki naścienne samoprzylepne
- GB Self-adhesive hanging hooks
- D Selbstklebende Wandhaken
- RUS Крючки настенные на липучках

- CZ Háčky nástěnné samolepící
- RO Cârige perete autocolante
- H Műanyag, fali kampó, öntapadós
- E Ganchos adhesivos para pared



No.	max (kg)	pcs	
74730	1.0	3	12/144

- PL Haczyki naścienne samoprzylepne
- GB Self-adhesive hanging hooks
- D Selbstklebende Wandhaken
- RUS Крючки настенные на липучках
- CZ Háčky nástěnné samolepící
- RO Cârige perete autocolante
- H Műanyag, fali kampó, öntapadós
- E Ganchos adhesivos para pared



No.	max (kg)	pcs	
74731	0.8	3	12/126

- PL Haczyki naścienne samoprzylepne  
GB Self-adhesive hanging hooks  
D Selbstklebende Wandhaken  
RUS Крючки настенные на липучках
- CZ Háčky nástěnné samolepící  
RO Cârige perete autocolante  
H Műanyag, fali kampó, öntapadós  
E Ganchos adhesivos para pared



No.	max (kg)	pcs	
74733	0.8	4	12/192

- PL Haczyki naścienne samoprzylepne  
GB Self-adhesive hanging hooks  
D Selbstklebende Wandhaken  
RUS Крючки настенные на липучках
- CZ Háčky nástěnné samolepící  
RO Cârige perete autocolante  
H Műanyag, fali kampó, öntapadós  
E Ganchos adhesivos para pared



No.	max (kg)	pcs	
74740	0.6	3	12/216

- PL Haczyki naścienne samoprzylepne  
GB Self-adhesive hanging hooks  
D Selbstklebende Wandhaken  
RUS Крючки настенные на липучках
- CZ Háčky nástěnné samolepící  
RO Cârige perete autocolante  
H Műanyag, fali kampó, öntapadós  
E Ganchos adhesivos para pared



No.	max (kg)	pcs	
74742	1.2	2	8/144

- PL Haczyki naścienne samoprzylepne  
GB Self-adhesive hanging hooks  
D Selbstklebende Wandhaken  
RUS Крючки настенные на липучках
- CZ Háčky nástěnné samolepící  
RO Cârige perete autocolante  
H Műanyag, fali kampó, öntapadós  
E Ganchos adhesivos para pared



No.	max (kg)	pcs	
74744	1.0	2	8/144

- PL Haczyki naścienne samoprzylepne  
GB Self-adhesive hanging hooks  
D Selbstklebende Wandhaken  
RUS Крючки настенные на липучках
- CZ Háčky nástěnné samolepící  
RO Cârige perete autocolante  
H Műanyag, fali kampó, öntapadós  
E Ganchos adhesivos para pared



No.	max (kg)	pcs	
74734	0.4	6	16/192

- PL Haczyki naścienne samoprzylepne  
GB Self-adhesive hanging hooks  
D Selbstklebende Wandhaken  
RUS Крючки настенные на липучках
- CZ Háčky nástěnné samolepící  
RO Cârige perete autocolante  
H Műanyag, fali kampó, öntapadós  
E Ganchos adhesivos para pared



No.	max (kg)	pcs	
74741	1.5	2	12/216

- PL Haczyki naścienne samoprzylepne  
GB Self-adhesive hanging hooks  
D Selbstklebende Wandhaken  
RUS Крючки настенные на липучках
- CZ Háčky nástěnné samolepící  
RO Cârige perete autocolante  
H Műanyag, fali kampó, öntapadós  
E Ganchos adhesivos para pared

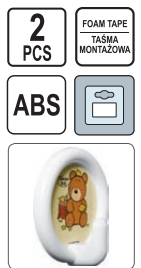

No.	max (kg)	pcs	
74743	1.0	2	12/144

- PL Haczyki naścienne samoprzylepne  
GB Self-adhesive hanging hooks  
D Selbstklebende Wandhaken  
RUS Крючки настенные на липучках
- CZ Háčky nástěnné samolepící  
RO Cârige perete autocolante  
H Műanyag, fali kampó, öntapadós  
E Ganchos adhesivos para pared

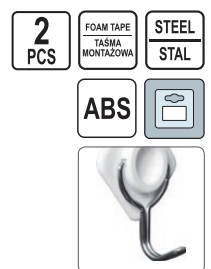

No.	max (kg)	pcs	
74750	1.0	2	16/192

- PL Haczyki naścienne samoprzylepne  
 GB Self-adhesive hanging hooks  
 D Selbstklebende Wandhaken  
 RUS Крючки настенные на липучках  
 CZ Háčky nástěnné samolepící  
 RO Cârige perete autocolante  
 H Műanyag, fali kampó, öntapadós  
 E Ganchos adhesivos para pared

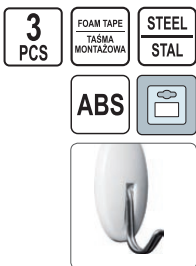

No.	max (kg)	pcs	
74751	0.8	3	12/192

- PL Haczyki naścienne samoprzylepne  
 GB Self-adhesive hanging hooks  
 D Selbstklebende Wandhaken  
 RUS Крючки настенные на липучках  
 CZ Háčky nástěnné samolepící  
 RO Cârige perete autocolante  
 H Műanyag, fali kampó, öntapadós  
 E Ganchos adhesivos para pared

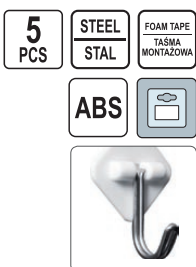

No.	max (kg)	pcs	
74752	0.4	5	16/288

- PL Haczyki naścienne szpilkowe  
 GB Wall hooks with pins  
 D Wandhaken, mit Nadeln  
 RUS Крючки настенные шпильковые  
 CZ Háčky do panelu Twenty  
 RO Cârige perete cu bolturi  
 H Műanyag, fali kampó, körmös  
 E Ganchos de alfiler para pared

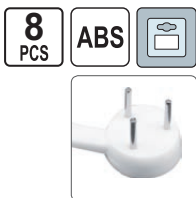

No.	max (kg)	pcs	
74753	3.0	8	24/288

- PL Haczyki naścienne na wkręt  
 GB Wall hooks with screws  
 D Wandhaken zum Anschrauben  
 RUS Крючки настенные на шурупах  
 CZ Háčky nástěnné na šroub  
 RO Cârige perete cu șurub  
 H Műanyag, fali kampó, csavaros  
 E Ganchos atomillados para pared



No.	max (kg)	pcs	
74760	5.0	3	16/256

- PL Haczyki naścienne samoprzylepne  
 GB Self-adhesive hanging hooks  
 D Selbstklebende Wandhaken  
 RUS Крючки настенные на липучках  
 CZ Háčky nástěnné samolepící  
 RO Cârige perete autocolante  
 H Műanyag, fali kampó, öntapadós  
 E Ganchos adhesivos para pared

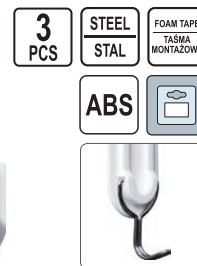

No.	max (kg)	pcs	
74752	1.2	3	12/216

- PL Haczyki naścienne samoprzylepne  
 GB Self-adhesive hanging hooks  
 D Selbstklebende Wandhaken  
 RUS Крючки настенные на липучках  
 CZ Háčky nástěnné samolepící  
 RO Cârige perete autocolante  
 H Műanyag, fali kampó, öntapadós  
 E Ganchos adhesivos para pared

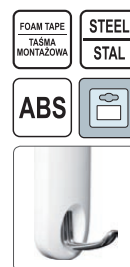

No.	max (kg)	pcs	
74754	4.5	1	8/128

- PL Haczyki naścienne szpilkowe  
 GB Wall hooks with pins  
 D Wandhaken, mit Nadeln  
 RUS Крючки настенные шпильковые  
 CZ Háčky do panelu Twenty  
 RO Cârige perete cu bolturi  
 H Műanyag, fali kampó, körmös  
 E Ganchos de alfiler para pared

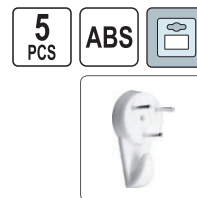

No.	max (kg)	pcs	
74755	5.0	5	24/288

- PL Haczyki naścienne na wkręt  
 GB Wall hooks with screws  
 D Wandhaken zum Anschrauben  
 RUS Крючки настенные на шурупах  
 CZ Háčky nástěnné na šroub  
 RO Cârige perete cu șurub  
 H Műanyag, fali kampó, csavaros  
 E Ganchos atomillados para pared



No.	max (kg)	pcs	
74761	8.0	3	12/192



- PL Ochraniacze na narożniki meblowe  
 GB Corner cushions  
 D Eckenschoner für Möbel  
 RUS Насадки на углы мебели
- CZ Chrániče na rohy nábytku  
 RO Protecție colțuri mobilă  
 H Bútor sarokvédő  
 E Protectores esquineros para muebles



No.	pcs	
74771	4	16/288

- PL Ochraniacze na narożniki meblowe  
 GB Corner cushions  
 D Eckenschoner für Möbel  
 RUS Насадки на углы мебели
- CZ Chrániče na rohy nábytku  
 RO Protecție colțuri mobilă  
 H Bútor sarokvédő  
 E Protectores esquineros para muebles



No.	pcs	
74773	4	12/144

- PL Zabezpieczenie otwarcia drzwi meblowych  
 GB Multi-purpose latches  
 D Schutzsicherung gegen das Öffnen der Möbeltüren  
 RUS Блокатор открывания дверей мебели
- CZ Pojistka proti otevření nábytkových dveří  
 RO Protecție deschidere uși mobilă  
 H Bútorajtó-űtköző  
 E Protectores para las portezuelas de muebles para prevenir su apertura



No.	pcs	
74776	2	12/216

- PL Hak  
 GB Hook  
 D Haken  
 RUS Крюк
- CZ Hák  
 RO Cârțig  
 H Kampó  
 E Gancho



No.	L (mm)	pcs packing	
78450	300	30	30/120

- PL Ochraniacze na narożniki meblowe  
 GB Corner cushions  
 D Eckenschoner für Möbel  
 RUS Насадки на углы мебели
- CZ Chrániče na rohy nábytku  
 RO Protecție colțuri mobilă  
 H Bútor sarokvédő  
 E Protectores esquineros para muebles



No.	pcs	
74772	4	16/288

- PL Zabezpieczenie otwarcia drzwi meblowych  
 GB Multi-purpose latches  
 D Schutzsicherung gegen das Öffnen der Möbeltüren  
 RUS Блокатор открывания дверей мебели
- CZ Pojistka proti otevření nábytkových dveří  
 RO Protecție deschidere uși mobilă  
 H Bútorajtó-űtköző  
 E Protectores para las portezuelas de muebles para prevenir su apertura



No.	pcs	
74775	2	16/256

- PL Zabezpieczenie odkręcania kurków kuchennych  
 GB Oven knob covers  
 D Schutz gegen das Abdrehen von Küchenhähnen  
 RUS Блокатор открывания кухонных кранов
- CZ Pojistka proti otevření kuchyňských kohoutků  
 RO Protecție defacere mâneră bucatărie  
 H Gáztűzhely csapjának kinyitása ellen védő sapka  
 E Protectores para las llaves de cocina para prevenir su apertura



No.	pcs	
74777	2	8/96

- PL Hak  
 GB Hook  
 D Haken  
 RUS Крюк
- CZ Hák  
 RO Cârțig  
 H Kampó  
 E Gancho



No.	L (mm)	pcs packing	
78451	300	30	60/120

PL Wieszak gospodarczy  
GB Tool holder  
D Wirtschaftshängevorrichtung  
RUS Хозяйственная вешалка

CZ Věšák pro domácnost  
RO Umeraș de casă  
H Háztartási akasztó  
E Percha

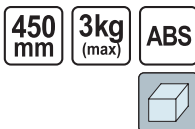

No.	L (mm)	pcs
74702	450	20

PL Wieszaki montowane do ściany  
GB Storage hangers set  
D Montagehaken für die Wand  
RUS Крючки на стену

CZ Věšáky na montáž do stěny  
RO Cârligie montate pe perete  
H Falra szerelhető akasztó  
E Ganchos para paredes



No.	Ø (mm)	pcs
74681	9	2

PL Wieszaki montowane do ściany  
GB Storage hangers set  
D Montagehaken für die Wand  
RUS Крючки на стену

CZ Věšáky na montáž do stěny  
RO Cârligie montate pe perete  
H Falra szerelhető akasztó  
E Ganchos para paredes



No.	Ø (mm)	pcs
74688	6	5

PL Wieszak montowany do ściany  
GB Storage hanger  
D Montagehaken für die Wand  
RUS Крючок на стену

CZ Věšák na montáž do stěny  
RO Cârlig montat pe perete  
H Falra szerelhető akasztó  
E Gancho para paredes



No.	Ø (mm)	pcs
74695	8	12/144

PL Wieszaki montowane do ściany  
GB Storage hangers set  
D Montagehaken für die Wand  
RUS Крючки на стену

CZ Věšáky na montáž do stěny  
RO Cârligie montate pe perete  
H Falra szerelhető akasztó  
E Ganchos para paredes



No.	Ø (mm)	pcs
74680	6	4

PL Wieszaki montowane do ściany  
GB Storage hangers set  
D Montagehaken für die Wand  
RUS Крючки на стену

CZ Věšáky na montáž do stěny  
RO Cârligie montate pe perete  
H Falra szerelhető akasztó  
E Ganchos para paredes



No.	Ø (mm)	pcs
74685	11	2

PL Wieszaki montowane do ściany  
GB Storage hangers set  
D Montagehaken für die Wand  
RUS Крючки на стену

CZ Věšáky na montáž do stěny  
RO Cârligie montate pe perete  
H Falra szerelhető akasztó  
E Ganchos para paredes



No.	Ø (mm)	pcs
74689	6	8

PL Klipsy do przewodów  
GB Cable clips  
D Kabelspangen  
RUS Скобы для кабеля

CZ Spony na kabely  
RO Cleme pt. cabluri  
H Kábelrögzítő  
E Clips para cables



No.	size / rozmiar (mm)	pcs
74973	25x25x10	6
74974	37x35x15	4
74975	60x50x25	2

PL Organizér do przewodów  
 GB Cable organizer  
 D Organizer für Leitungen  
 RUS Органайзер для проводов

CZ Organizér vodičů  
 RO Kábelrendező  
 H Organizátor pt. cabluri  
 E Organizador para cables



No.	pcs	
74980	10	25/300

PL Organizér gumowy „żółwik”  
 GB Rubber organizer „turtle”  
 D Gummiorganizer „Schildkröte”  
 RUS Резиновый органайзер для проводов «черепашка»

CZ Gumový organizér „želvička”  
 RO Organizator de cauciuc „broască țestoasă”  
 H Gumi „teknősbéka” kábelrendező  
 E Organizador de caucho tipo „tortuga”



No.	
74983	25/300

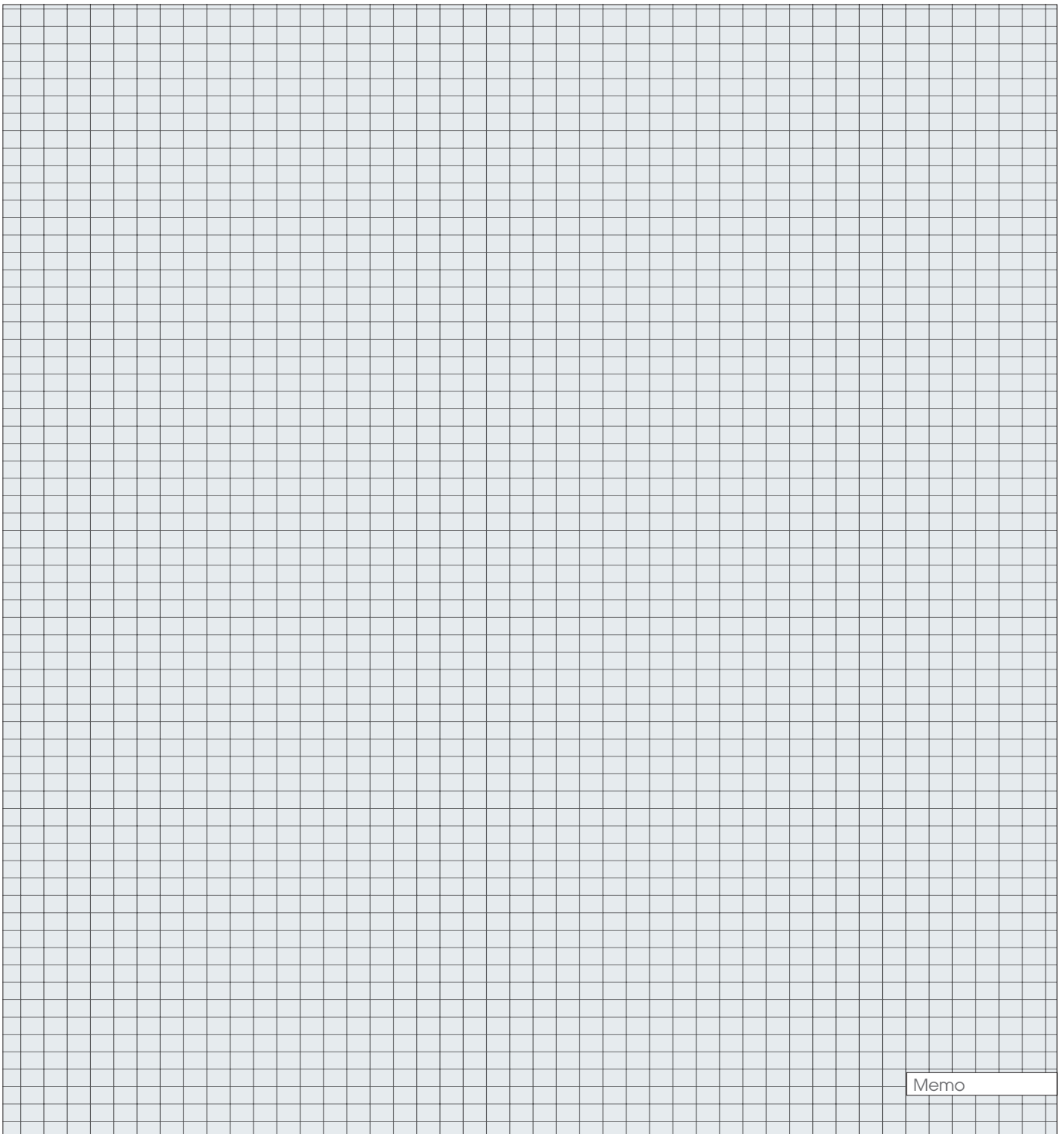
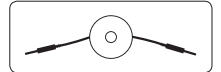





21

Health & safety products  
Artykuły BHP



<b>Gloves</b> Rękawice		300-304
<b>Goggles &amp; shields</b> Okulary i osłony przeciwodpryskowe		304-305
<b>Dust masks</b> Maski przeciwpyłowe		305
<b>Welding goggles &amp; masks</b> Okulary i maski spawalnicze		305-309
<b>Knee pads</b> Nakolanniki		309-310
<b>Hearing protectors</b> Nauszniki przeciwhałasowe		310
<b>Safety helmets</b> Kaski ochronne		310
<b>Protection sets</b> Zestawy ochronne		310

<b>Plastic capes</b> Peleryny foliowe		310
<b>Rain boots</b> Kalosze		311
<b>Working shoes</b> Buty robocze		312
<b>Safety sandals</b> Sandale robocze		312
<b>Shoes accessories</b> Akcesoria do obuwia		312
<b>Working clothes</b> Odzież robocza		313-314
<b>Safety vests</b> Kamizelki ostrzegawcze		313
<b>Painting suits</b> Kombinezony malarskie		313
<b>Waterproof jackets</b> Kurtki przeciwdeszczowe		313
<b>Garden trousers</b> Spodnie ogrodnicze		314
<b>Working clothes</b> Odzież robocza		314

PL Rękawice robocze  
GB Working gloves  
D Arbeitshandschuh  
RUS Перчатки

CZ Pracovní rukavice  
RO Mănuși  
H Védőkesztyű  
E Guantes



No.	
74000	12/120

PL Rękawice robocze  
GB Working gloves  
D Arbeitshandschuh  
RUS Перчатки

CZ Pracovní rukavice  
RO Mănuși  
H Védőkesztyű  
E Guantes



No.	
74001	60

PL Rękawice robocze  
GB Working gloves  
D Arbeitshandschuh  
RUS Перчатки

CZ Pracovní rukavice  
RO Mănuși  
H Védőkesztyű  
E Guantes



**FLO**

No.	pairs / pary	
74100	1	12/300

PL Rękawice robocze  
GB Working gloves  
D Arbeitshandschuh  
RUS Перчатки

CZ Pracovní rukavice  
RO Mănuși  
H Védőkesztyű  
E Guantes



No.	pairs / pary	packing	
74104	1		10/240
74105	5		48

PL Rękawice robocze  
GB Working gloves  
D Arbeitshandschuh  
RUS Перчатки

CZ Pracovní rukavice  
RO Mănuși  
H Védőkesztyű  
E Guantes



No.	
74004	12/120

PL Rękawice robocze  
GB Working gloves  
D Arbeitshandschuh  
RUS Перчатки

CZ Pracovní rukavice  
RO Mănuși  
H Védőkesztyű  
E Guantes



No.	
74094	240

PL Rękawice robocze  
GB Working gloves  
D Arbeitshandschuh  
RUS Перчатки

CZ Pracovní rukavice  
RO Mănuși  
H Védőkesztyű  
E Guantes



No.	pairs / pary	size / rozmiar	packing	
74102	1	8		10/240
74103	5	8		48

PL Rękawice robocze  
GB Working gloves  
D Arbeitshandschuh  
RUS Перчатки

CZ Pracovní rukavice  
RO Mănuși  
H Védőkesztyű  
E Guantes



No.	pairs / pary	packing	
74106	1		10/240
74107	5		48

PL Rękawice robocze  
GB Working gloves  
D Arbeitshandschuh  
RUS Перчатки

CZ Pracovní rukavice  
RO Mănuși  
H Védőkesztyű  
E Guantes

10  
SIZE / ROZMIAR



No.	
74108	240

PL Rękawice robocze  
GB Working gloves  
D Arbeitshandschuh  
RUS Перчатки

CZ Pracovní rukavice  
RO Mănuși  
H Védőkesztyű  
E Guantes



FLO

No.	size / rozmiar	
74125	8	12/300
74130	9	12/300
74131	10	12/300

PL Rękawice robocze  
GB Working gloves  
D Arbeitshandschuh  
RUS Перчатки

CZ Pracovní rukavice  
RO Mănuși  
H Védőkesztyű  
E Guantes



FLO

No.	size / rozmiar	
74127	8	12/300
74134	9	12/300
74135	10	12/300

PL Rękawice ogrodnicze  
GB Gardening gloves  
D Arbeitshandschuh  
RUS Перчатки

CZ Pracovní rukavice  
RO Mănuși  
H Védőkesztyű  
E Guantes

8  
SIZE / ROZMIAR



FLO

No.	size / rozmiar	
74117	8	50/1000

PL Rękawice robocze  
GB Working gloves  
D Arbeitshandschuh  
RUS Перчатки

CZ Pracovní rukavice  
RO Mănuși  
H Védőkesztyű  
E Guantes



FLO

No.	pairs / pary	size / rozmiar	
74110	1	9	12/300
74111	3	9	4/100

PL Rękawice robocze  
GB Working gloves  
D Arbeitshandschuh  
RUS Перчатки

CZ Pracovní rukavice  
RO Mănuși  
H Védőkesztyű  
E Guantes



FLO

No.	size / rozmiar	
74126	8	12/300
74132	9	12/300
74133	10	12/300

PL Rękawice robocze  
GB Working gloves  
D Arbeitshandschuh  
RUS Перчатки

CZ Pracovní rukavice  
RO Mănuși  
H Védőkesztyű  
E Guantes



FLO

No.	size / rozmiar	
74128	8	12/300
74136	9	12/300
74137	10	12/300

PL Rękawice ogrodnicze  
GB Gardening gloves  
D Arbeitshandschuh  
RUS Перчатки

CZ Pracovní rukavice  
RO Mănuși  
H Védőkesztyű  
E Guantes

8  
SIZE / ROZMIAR



FLO

No.	size / rozmiar	
74121	8	50/1000

PL Rękawice ogrodnicze  
GB Gardening gloves  
D Arbeitshandschuh  
RUS Перчатки

CZ Pracovní rukavice  
RO Mănuși  
H Védőkesztyű  
E Guantes



No.	size / rozmiar	
74123	8	50/1000

PL Rękawice ogrodnicze  
GB Gardening gloves  
D Arbeitshandschuh  
RUS Перчатки

CZ Pracovní rukavice  
RO Mănuși  
H Védőkesztyű  
E Guantes



No.	size / rozmiar	
74115	8	50/1000

PL Rękawice robocze  
GB Working gloves  
D Arbeitshandschuh  
RUS Перчатки  
CZ Pracovní rukavice  
RO Mănuși  
H Védőkesztyű  
E Guantes



No.		
74151		12/120

PL Rękawice robocze  
GB Working gloves  
D Arbeitshandschuh  
RUS Перчатки  
CZ Pracovní rukavice  
RO Mănuși  
H Védőkesztyű  
E Guantes



No.	pairs / pary	packing	
74162	1		600
74164	10		60

PL Rękawice ogrodnicze  
GB Gardening gloves  
D Arbeitshandschuh  
RUS Перчатки

CZ Pracovní rukavice  
RO Mănuși  
H Védőkesztyű  
E Guantes



No.	size / rozmiar	
74113	8	50/1000

PL Rękawice robocze  
GB Working gloves  
D Arbeitshandschuh  
RUS Перчатки  
CZ Pracovní rukavice  
RO Mănuși  
H Védőkesztyű  
E Guantes



No.		
74150		12/120

PL Rękawice robocze  
GB Working gloves  
D Arbeitshandschuh  
RUS Перчатки  
CZ Pracovní rukavice  
RO Mănuși  
H Védőkesztyű  
E Guantes



No.		
74160		12/120

PL Rękawice robocze  
GB Working gloves  
D Arbeitshandschuh  
RUS Перчатки  
CZ Pracovní rukavice  
RO Mănuși  
H Védőkesztyű  
E Guantes



No.	pairs / pary	size / rozmiar	
74087	12	8	20
74088	12	9	20
74089	12	10	20



PL Rękawice robocze  
GB Working gloves  
D Arbeitshandschuh  
RUS Перчатки  
CZ Pracovní rukavice  
RO Mănuși  
H Védőkesztyű  
E Guantes



No.	size / rozmiar	
74146	10	12/120

PL Rękawice robocze  
GB Working gloves  
D Arbeitshandschuh  
RUS Перчатки  
CZ Pracovní rukavice  
RO Mănuși  
H Védőkesztyű  
E Guantes



No.	size / rozmiar	
74079	9	12/120
74080	10	12/120

PL Rękawice robocze  
GB Working gloves  
D Arbeitshandschuh  
RUS Перчатки  
CZ Pracovní rukavice  
RO Mănuși  
H Védőkesztyű  
E Guantes



No.	pairs / pary	size / rozmiar	
74152	12	8	20
74153	12	9	20
74154	12	10	20

PL Rękawice robocze  
GB Working gloves  
D Arbeitshandschuh  
RUS Перчатки  
CZ Pracovní rukavice  
RO Mănuși  
H Védőkesztyű  
E Guantes



No.	size / rozmiar	
74140	10	12/120

PL Rękawice robocze  
GB Working gloves  
D Arbeitshandschuh  
RUS Перчатки  
CZ Pracovní rukavice  
RO Mănuși  
H Védőkesztyű  
E Guantes

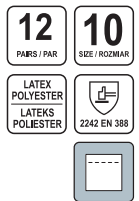

No.	pairs / pary	size / rozmiar	
74145	12	10	10

PL Rękawice robocze  
GB Working gloves  
D Arbeitshandschuh  
RUS Перчатки  
CZ Pracovní rukavice  
RO Mănuși  
H Védőkesztyű  
E Guantes



No.	pairs / pary	size / rozmiar	
74077	12	9	10
74078	12	10	10

PL Rękawice ochronne, ocieplane  
GB Insulated gloves  
D Isolierhandschuh  
RUS Утепленные перчатки

CZ Zimní rukavice  
RO Mănuși izolate  
H Szigetelt kesztyű  
E Gants isolés

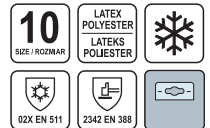

No.	size / rozmiar	
74148	10	12/120

PL Rękawice robocze  
GB Working gloves  
D Arbeitshandschuh  
RUS Перчатки

CZ Pracovní rukavice  
RO Mănuși  
H Védőkesztyű  
E Guantes



No.	pairs / pary	size / rozmiar	
74084	12	8	10
74085	12	9	10
74086	12	10	10

PL Rękawice robocze  
GB Working gloves  
D Arbeitshandschuh  
RUS Перчатки

CZ Pracovní rukavice  
RO Mănuși  
H Védőkesztyű  
E Guantes



No.	pairs / pary	size / rozmiar	
74142	12	10	10

PL Osłona twarzy przeciwdpryskowa  
GB Polycarbonate protection shield  
D Schutzmaske  
RUS Маска защитная

CZ Ochranná přilba /polyuhličitan/  
RO Mască protecție  
H Hegesztősisak /polivenglán/  
E Pantalla protectora antipedacitos



No.	
74459	25/50

PL Okulary ochronne  
GB Safety glasses  
D Schutzbrille  
RUS Очки защитные открытые

CZ Ochranné brýle  
RO Ochelari pt. protecție  
H Védőszemüveg  
E Gafas protectoras



No.	type	
74501	HF-111	12/240

PL Okulary ochronne  
GB Safety glasses  
D Schutzbrille  
RUS Очки защитные открытые

CZ Ochranné brýle  
RO Ochelari pt. protecție  
H Védőszemüveg  
E Gafas protectoras



No.	type	
74503	DY-8525	15/150

PL Rękawice robocze  
GB Working gloves  
D Arbeitshandschuh  
RUS Перчатки

CZ Pracovní rukavice  
RO Mănuși  
H Védőkesztyű  
E Guantes



No.	size / rozmiar	
74081	9	12/120
74082	10	12/120

PL Osłona twarzy przeciwdpryskowa  
GB Polycarbonate protection shield  
D Schutzmaske  
RUS Маска защитная

CZ Ochranná přilba /polyuhličitan/  
RO Mască protecție  
H Hegesztősisak /polivenglán/  
E Pantalla protectora antipedacitos



No.	
74460	20

PL Okulary ochronne  
GB Safety glasses  
D Schutzbrille  
RUS Очки защитные открытые

CZ Ochranné brýle  
RO Ochelari pt. protecție  
H Védőszemüveg  
E Gafas protectoras



No.	type	
74502	HF-110	12/240

PL Okulary ochronne  
GB Safety glasses  
D Schutzbrille  
RUS Очки защитные открытые

CZ Ochranné brýle  
RO Ochelari pt. protecție  
H Védőszemüveg  
E Gafas protectoras



No.	type	
74504	DY-8526	15/150

PL Okulary ochronne  
GB Safety glasses  
D Schutzbrille  
RUS Очки защитные открытые

CZ Ochranné brýle  
RO Ochelari pt. protectie  
H Védőszemüveg  
E Gafas protectoras



No.	type	pcs packing
74508	HF-103	10/120

PL Półmaski filtrujące jednorazowe  
GB Disposable dust masks  
D Atemschutzmaske  
RUS Респиратор противопылевой одноразовый  
CZ Protiprašná maska  
RO Masca praf  
H Eldobható porvédőmaszk  
E Mascarilla desechable para protección contra polvo



No.	type	pcs packing
74540	CDC3S	5 25/100

PL Półmaski filtrujące jednorazowe  
GB Disposable dust masks  
D Atemschutzmaske  
RUS Респиратор противопылевой одноразовый  
CZ Protiprašná maska  
RO Masca praf  
H Eldobható porvédőmaszk  
E Mascarilla desechable para protección contra polvo



No.	type	pcs packing
74542	CFY3S	5 25/100

PL Okulary spawalnicze  
GB Welding goggles  
D Schweisserbrille  
RUS Очки газосварщика

CZ Brýle svářečské  
RO Ochelari pt. sudura  
H Hegesztőszemüveg  
E Gafas para soldar

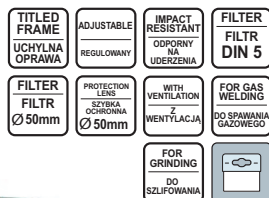

No.	type	pcs packing
74400		25/100

PL Okulary ochronne  
GB Safety glasses  
D Schutzbrille  
RUS Очки защитные открытые

CZ Ochranné brýle  
RO Ochelari pt. protectie  
H Védőszemüveg  
E Gafas protectoras



No.	type	pcs packing
74509	HF-105	10/100

PL Półmaski filtrujące jednorazowe  
GB Disposable dust masks  
D Atemschutzmaske  
RUS Респиратор противопылевой одноразовый  
CZ Protiprašná maska  
RO Masca praf  
H Eldobható porvédőmaszk  
E Mascarilla desechable para protección contra polvo



No.	type	pcs packing
74541	CDC3V	5 15/60

PL Półmaski filtrujące jednorazowe  
GB Disposable dust masks  
D Atemschutzmaske  
RUS Респиратор противопылевой одноразовый  
CZ Protiprašná maska  
RO Masca praf  
H Eldobható porvédőmaszk  
E Mascarilla desechable para protección contra polvo



No.	type	pcs packing
74543	CFY3V	5 15/60

PL Okulary spawalnicze  
GB Welding goggles  
D Schweisserbrille  
RUS Очки газосварщика

CZ Brýle svářečské  
RO Ochelari pt. sudura  
H Hegesztőszemüveg  
E Gafas para soldar

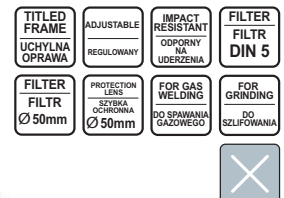

No.	type	pcs packing
74410		5/100

- PL Okulary spawalnicze  
 GB Welding goggles  
 D Schweisserbrille  
 RUS Очки газосварщика
- CZ Brýle svářečské  
 RO Ochelari pt. sudura  
 H Hegesztőszemüveg  
 E Gafas para soldar

TITLED FRAME  
 UCHYLNA OPRAWA

ADJUSTABLE  
 REGULOWANY

IMPACT RESISTANT  
 OPOPNY NA UDERZENIA

FILTER  
 FILTR  
 DIN 5

FILTER  
 FILTR  
 Ø 50mm

PROTECTION LENS  
 SZYBKA OCHRONNA  
 Ø 50mm

FOR GAS WELDING  
 DO SPAWANIA  
 GAZOWEGO

FOR GRINDING  
 DO SZLIFOWANIA



No.	type	
74411		10/100

- PL Maska spawalnicza  
 GB Welding mask  
 D Schweissermaske  
 RUS Щиток сварщика  
 CZ Svářečská maska  
 RO Mască de sudură  
 H Hegesztőpajzs  
 E Mascara de soldador



FILTER SIZE  
 ROZMIAR FILTRA  
 50x100 mm

222x372 x80 mm

FILTER  
 FILTR  
 DIN 10

WEIGHT WITHOUT LENS  
 WAGA BEZ SZKIEŁ  
 366 g



No.	type	
74442	TSSM	30

- PL Maska spawalnicza  
 GB Welding mask  
 D Schweissermaske  
 RUS Щиток сварщика  
 CZ Svářečská maska  
 RO Mască de sudură  
 H Hegesztőpajzs  
 E Mascara de soldador



FILTER SIZE  
 ROZMIAR FILTRA  
 50x100 mm

257x450 x96 mm

WEIGHT WITHOUT LENS  
 WAGA BEZ SZKIEŁ  
 455 g



No.	type	
74450	TSD-3	20

- PL Przyłbica spawalnicza z podglądem  
 GB Welding mask  
 D Schweissermaske  
 RUS Щиток сварщика с подсмотром
- CZ Svářečská přilba s nakoukáváním  
 RO Mască de sudură cu geam  
 H Hegesztősisak kitekintővel  
 E Mascara de soldador con mirador



FILTER SIZE  
 ROZMIAR FILTRA  
 50x100 mm  
 DIN 8-13

SPECTACLE LENS SIZE  
 SZYBKA OCHRONNA  
 20x100 mm  
 (DIN 5)

225x290 x175 mm

FILTER  
 FILTR  
 DIN 10

WEIGHT WITHOUT LENS  
 WAGA BEZ SZKIEŁ  
 427 g



No.	type	
74448	PS-3	10

- PL Maska spawalnicza  
 GB Welding mask  
 D Schweissermaske  
 RUS Щиток сварщика  
 CZ Svářečská maska  
 RO Mască de sudură  
 H Hegesztőpajzs  
 E Mascara de soldador

FILTER SIZE  
 ROZMIAR FILTRA  
 50x100 mm

237x359 x78 mm

FILTER  
 FILTR  
 DIN 8

WEIGHT WITHOUT LENS  
 WAGA BEZ SZKIEŁ  
 268 g



No.	type	
74440	TSM-3	30

- PL Maska spawalnicza  
 GB Welding mask  
 D Schweissermaske  
 RUS Щиток сварщика  
 CZ Svářečská maska  
 RO Mască de sudură  
 H Hegesztőpajzs  
 E Mascara de soldador



FILTER SIZE  
 ROZMIAR FILTRA  
 50x100 mm

SPECTACLE LENS SIZE  
 SZYBKA OCHRONNA  
 20x100 mm  
 (DIN 5)

222x372 x80 mm

FILTER  
 FILTR  
 DIN 10

WEIGHT WITHOUT LENS  
 WAGA BEZ SZKIEŁ  
 408 g



No.	type	
74443	TSMF	20

- PL Przyłbica spawalnicza z podglądem  
 GB Welding mask  
 D Schweissermaske  
 RUS Щиток сварщика с подсмотром
- CZ Svářečská přilba s nakoukáváním  
 RO Mască de sudură cu geam  
 H Hegesztősisak kitekintővel  
 E Mascara de soldador con mirador



FILTER SIZE  
 ROZMIAR FILTRA  
 50x100 mm  
 DIN 8-13

SPECTACLE LENS SIZE  
 SZYBKA OCHRONNA  
 20x100 mm  
 (DIN 5)

195x265 x170 mm

FILTER  
 FILTR  
 DIN 10

WEIGHT WITHOUT LENS  
 WAGA BEZ SZKIEŁ  
 332 g



No.	type	
74447	PSMP	20

- PL Maska spawalnicza  
 GB Welding mask  
 D Schweissermaske  
 RUS Щиток сварщика  
 CZ Svářečská maska  
 RO Mască de sudură  
 H Hegesztőpajzs  
 E Mascara de soldador



110x90 mm

FILTER  
 FILTR  
 DIN 12



No.	type	
74441		20

PL Przyłbica spawalnicza  
GB Welding mask  
D Schweissmaske  
RUS Щиток сварщика

CZ Svářečská přilba s nakoukáváním  
RO Mască de sudură cu geam  
H Hegesztősisak kitékintővel  
E Mascara de soldador con mirador



No.	42
74457	20

PL Przyłbica spawalnicza samościemniająca  
GB Auto-darkening welding helmet  
D Schweissmaske, selbstverdunkelnd  
RUS Маска для сварки, самостоятельно затемняющаяся  
CZ Svářečská kukla samostmívaci  
RO Mască de sudură auto-întunecare  
H Önmagától sötétedő hegesztőpajzs  
E Casco auto-oscurecedor para soldadura

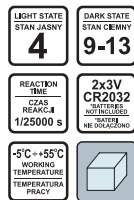

No.	6
74436	6

PL Przyłbica spawalnicza samościemniająca  
GB Auto-darkening welding helmet  
D Schweissmaske, selbstverdunkelnd  
RUS Маска для сварки, самостоятельно затемняющаяся  
CZ Svářečská kukla samostmívaci  
RO Mască de sudură auto-întunecare  
H Önmagától sötétedő hegesztőpajzs  
E Casco auto-oscurecedor para soldadura

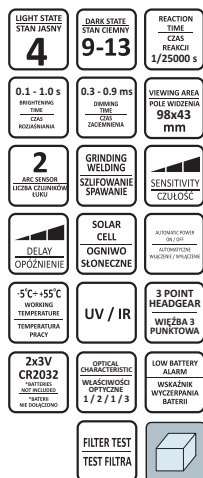

No.	6
74481	6

PL Przyłbica spawalnicza samościemniająca  
GB Auto-darkening welding helmet  
D Schweissmaske, selbstverdunkelnd  
RUS Маска для сварки, самостоятельно затемняющаяся  
CZ Svářečská kukla samostmívaci  
RO Mască de sudură auto-întunecare  
H Önmagától sötétedő hegesztőpajzs  
E Casco auto-oscurecedor para soldadura

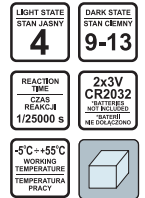

No.	6
74435	6

PL Przyłbica spawalnicza samościemniająca  
GB Auto-darkening welding helmet  
D Schweissmaske, selbstverdunkelnd  
RUS Маска для сварки, самостоятельно затемняющаяся  
CZ Svářečská kukla samostmívaci  
RO Mască de sudură auto-întunecare  
H Önmagától sötétedő hegesztőpajzs  
E Casco auto-oscurecedor para soldadura

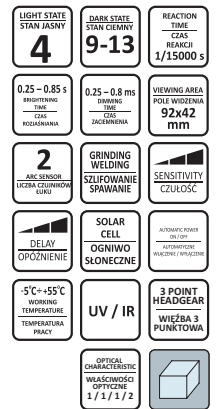

No.	6
74480	6

PL Przyłbica spawalnicza samościemniająca  
GB Auto-darkening welding helmet  
D Schweissmaske, selbstverdunkelnd  
RUS Маска для сварки, самостоятельно затемняющаяся  
CZ Svářečská kukla samostmívaci  
RO Mască de sudură auto-întunecare  
H Önmagától sötétedő hegesztőpajzs  
E Casco auto-oscurecedor para soldadura

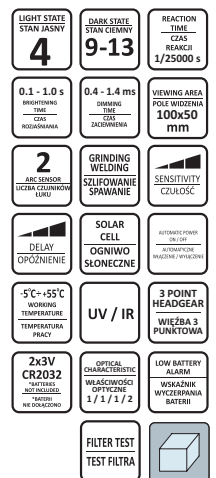

No.	6
74482	6

- PL Przyłbica spawalnicza CZ Svářečská maska  
 GB Welding helmet RO Mască de sudură  
 D Schweissermaske H Hegesztőpajzs  
 RUS Щиток сварщика E Mascara de soldador



No.	Icon
74449	12

- PL Oslona wymienna z tworzywa  
 GB PC visor  
 D Austauschbare Abdeckung aus Kunststoff  
 RUS Заменяемая защита из пластмассы  
 CZ Vyměnitelný kryt z plastu  
 RO Protecție schimbabilă din plastic  
 H Cserélhető, műanyag pajzs  
 E Protección reemplazable de materia plástica



No.	size (mm)	Icon
74463	305x200	200
74464	395x200	150

- PL Oslona filtra CZ Ochrana filtra  
 GB Filter shield RO Aparătoare de filtru  
 D Filterabdeckung H Szűrőfedél  
 RUS Кожух фильтра E Protección de filtro



No.	mm	type / typ	Icon
74451	50x100	DIN 0	150

- PL Przyłbica z osłoną wymienną  
 GB Face shield with PC visor  
 D Chweisserschutzhelm mit austauschbarer Abdeckung  
 RUS Шлем с заменяемой защитой  
 CZ Štít s vyměnitelným krytem  
 RO Vizieră cu protecție schimbabilă  
 H Arcvédő cserélhető pajzsral  
 E Antifaz con protección reemplazable



No.	Icon
74461	40

- PL Przyłbica z osłoną wymienną i nausznikami przeciwhałasowymi  
 GB Face shield with steel mesh and ear muff  
 D Schweisserschutzhelm mit austauschbarer Abdeckung und Ohrenschützer gegen Lärm  
 RUS Шлем с заменяемой защитой и наушниками против шума  
 CZ Štít s vyměnitelným krytem a chrániči proti hluku  
 RO Vizieră cu protecție schimbabilă și căști de protecție antizgomot  
 H Arcvédő cserélhető pajzsral és fülvédő kagylóval  
 E Antifaz con protección reemplazable y protectores de oídos



No.	Icon
74462	40

- PL Filtr spawalniczy CZ Filtr svářečský  
 GB Welding filter RO Filtru pt. sudării  
 D Vorsatzglas H Hegesztőszűrő  
 RUS Фильтр для сварки E Pantalla de filtro de soldador



No.	mm	type / typ	Icon
74452	50x100	DIN 8	100
74453	50x100	DIN 9	100
74454	50x100	DIN 10	100
74455	50x100	DIN 11	100
74456	50x100	DIN 12	100

PL Osłona filtra  
GB Filter protection  
D Filtereinsatz  
RUS Кожух фильтра

CZ Ochranná folie filtru  
RO Carcasă filtru  
H Szűrő-védőburkolat  
E Protección del filtro



No.	mm	type	for / dla	☐
74467	345x190	OTS	74459	100

PL Osłona filtra przybicy samościemniającej  
GB Self-dimming helmet filter protection  
D Filtereinsatz eines selbstabdunkelnden Schutzhelms  
RUS Кожух фильтра самозатемняющегося шлота  
CZ Ochranná folie filtru samostmívaci kukly  
RO Carcasă filtru vizieră heliomată  
H Hegesztőpajzs szűrő, önsötétedő  
E Protección del filtro de visera autooscurecedora



No.	mm	pcs	☐
74439	90x110	5	20

PL Nakolanniki  
GB Knee pads  
D Knieschützer  
RUS Наколенники

CZ Chráníče kolen  
RO Genunchiere  
H Térdvédő  
E Rodilleras



No.	☐
74610	20

PL Nakolanniki  
GB Knee pads  
D Knieschützer  
RUS Наколенники

CZ Chráníče kolen  
RO Genunchiere  
H Térdvédő  
E Rodilleras



No.	☐
74622	50

PL Osłona filtra  
GB Filter protection  
D Filtereinsatz  
RUS Кожух фильтра

CZ Ochranná folie filtru  
RO Carcasă filtru  
H Szűrő-védőburkolat  
E Protección del filtro



No.	mm	type	for / dla	☐
74466	350x200	OT 1-N	74460	10/100

PL Nakolanniki  
GB Knee pads  
D Knieschützer  
RUS Наколенники

CZ Chráníče kolen  
RO Genunchiere  
H Térdvédő  
E Rodilleras



No.	☐
74600	50

PL Nakolanniki  
GB Knee pads  
D Knieschützer  
RUS Наколенники

CZ Chráníče kolen  
RO Genunchiere  
H Térdvédő  
E Rodilleras



No.	☐
74620	12/48

PL Nakolanniki  
GB Knee pads  
D Knieschützer  
RUS Наколенники

CZ Chráníče kolen  
RO Genunchiere  
H Térdvédő  
E Rodilleras



No.	☐
74624	12/24

- PL Nakolanniki CZ Chrániče kolen  
 GB Knee pads RO Genunchiere  
 D Knieschützer H Térdvédő  
 RUS Наколенники E Rodilleras



No.	
74601	24

- PL Nauszniki przeciwhałasowe CZ Chrániče sluchu  
 GB Ear muff RO Antifoane  
 D Gehörschutz H Fülvédőt  
 RUS Средства защиты слуха E Protectores de la vista



No.	
74623	12/24

- PL Nauszniki przeciwhałasowe CZ Chrániče sluchu  
 GB Ear muff RO Antifoane  
 D Gehörschutz H Fülvédőt  
 RUS Средства защиты слуха E Protectores de la vista



No.	
74581	10/60

- PL Kask ochronny drwala  
 GB Lumberjack helmet  
 D Schutzhelm für Holzfäller  
 RUS Защитный шлем лесоруба  
 CZ Ochranná přilba pro dřevorubce  
 RO Casă de protecție pt. tăietor de lemne  
 H Favágó védősisak  
 E Casco de leñador



No.	
74201	8

- PL Nakolanniki CZ Chrániče kolen  
 GB Knee pads RO Genunchiere  
 D Knieschützer H Térdvédő  
 RUS Наколенники E Rodilleras



No.	
74602	6/36

- PL Nauszniki przeciwhałasowe CZ Chrániče sluchu  
 GB Ear muff RO Antifoane  
 D Gehörschutz H Fülvédőt  
 RUS Средства защиты слуха E Protectores de la vista



No.	
74580	60

- PL Kask ochronny  
 GB Safety helmet  
 D Schutzhelm  
 RUS Каска защитная  
 CZ Ochranná přilba  
 RO Cască de protecție  
 H Védősisak  
 E Casco de protección



No.	colour / kolor	
74190		40
74191		40
74192		40
74193		40
74194		40
74195		40

- PL Peleryna foliowa dziecięca  
 GB Kid plastic cape  
 D Folienumhang für Kinder  
 RUS Плащ-дождевик полиэтиленовый детский  
 CZ Dětská pláštěnka  
 RO Pelerina de ploaie pt. copii  
 H Gyermek műanyag pelerin  
 E Capa de plástico para niños



No.	
74640	50/400



PL Kalosze damskie  
GB Women's rain boots  
D Damen - Gummistiefel  
RUS Галоши женские

CZ Dámské galoše  
RO Cizme damă  
H Női gumicsizma  
E Chanclos para mujer

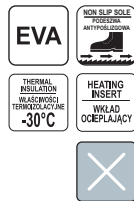

No.	size / rozmiar	model	
72831	36	LUNA	7
72832	37	LUNA	7
72833	38	LUNA	7
72834	39	LUNA	5
72835	40	LUNA	5
72836	41	LUNA	5

PL Kalosze damskie  
GB Women's rain boots  
D Damen - Gummistiefel  
RUS Галоши женские

CZ Dámské galoše  
RO Cizme damă  
H Női gumicsizma  
E Chanclos para mujer



No.	size / rozmiar	model	
72850	36	RAINNY BLACK	10
72851	37	RAINNY BLACK	10
72852	38	RAINNY BLACK	10
72853	39	RAINNY BLACK	10
72854	40	RAINNY BLACK	10

PL Buty gumowo - filcowe  
GB Felt PVC boots  
D Gummistiefel mit Filz  
RUS Сапоги резиновые с войлоком

CZ Holinky s filcem  
RO Cizme PVC  
H Gumi - filc csizma  
E Botas de goma fieltro

No.	size / rozmiar	
72871	40	5
72872	41	5
72873	42	5
72874	43	5
72875	44	5
72876	45	5
72877	46	5

PL Kalosze męskie  
GB Men's rain boots  
D Herren - Gummistiefel  
RUS Галоши мужские

CZ Pánské galoše  
RO Cizme bărbați  
H Férfi gumicsizma  
E Chanclos para hombre

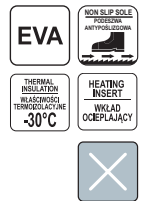

No.	size / rozmiar	model	
72840	41	PREDATOR XL	6
72841	42	PREDATOR XL	4
72842	43	PREDATOR XL	4
72843	44	PREDATOR XL	4
72844	45	PREDATOR XL	4
72845	46	PREDATOR XL	6
72846	47	PREDATOR XL	6

PL Kalosze męskie  
GB Men's rain boots  
D Herren - Gummistiefel  
RUS Галоши мужские

CZ Pánské galoše  
RO Cizme bărbați  
H Férfi gumicsizma  
E Chanclos para hombre



No.	size / rozmiar	model	
72858	41	GRAND BLACK	8
72859	42	GRAND BLACK	8
72860	43	GRAND BLACK	8
72861	44	GRAND BLACK	8
72862	45	GRAND BLACK	6
72863	46	GRAND BLACK	6
72864	47	GRAND BLACK	6



PL Sandały robocze  
 GB Safety sandals  
 D Arbeitshalbschuhe  
 RUS Полуботинки рабочие

CZ Pracovní polobotky  
 RO Papuc de lucru  
 H Munkavédelmi félcipő  
 E Zapato de trabajo



No.	size / rozmiar	model	
72801	39	SALTA	10
72802	40	SALTA	10
72803	41	SALTA	10
72804	42	SALTA	10
72805	43	SALTA	10
72806	44	SALTA	10
72807	45	SALTA	10
72808	46	SALTA	10
72809	47	SALTA	10

PL Płynny tłuszcz do obuwia  
 GB Oil spray  
 D Wartungs-Spray Schuhe  
 RUS Жидкий жир для обуви

CZ Olejový spray na obuv  
 RO Spray intretinere incaltaminte  
 H Cipőápoló olaj  
 E Aceite para botas



No.	ml	
72890	150	20

PL Antybakteryjna wkładka do butów  
 GB Antibacterial insole  
 D Antibakterielle Einlage für Schuhe  
 RUS Антибактериальная стелька

CZ Antibakteriální vložka do bot  
 RO Tălpici antibacterieni  
 H Antibakteriális cipőbetét  
 E Plantilla antibacterial



No.	size / rozmiar	thickness / grubość (mm)	
72683	39 / 40	3.2	50
72684	41 / 42	3.2	50
72685	43 / 44	3.2	50
72686	45 / 46	3.2	50



PL Sandały robocze  
 GB Safety sandals  
 D Arbeitshalbschuhe  
 RUS Полуботинки рабочие

CZ Pracovní polobotky  
 RO Papuc de lucru  
 H Munkavédelmi félcipő  
 E Zapato de trabajo



No.	size / rozmiar	model	
72821	39	SERRA	10
72822	40	SERRA	10
72823	41	SERRA	10
72824	42	SERRA	10
72825	43	SERRA	10
72826	44	SERRA	10
72827	45	SERRA	10
72828	46	SERRA	10
72829	47	SERRA	10

PL Spray ożywiający kolor do nubuku i zamszu  
 GB Ravvivant spray  
 D Wildleder und Nubuk Pflegespray  
 RUS Спрей освежающий цвет нубука и замши

CZ Spray na semišovou obuv  
 RO Spray revitalizant incaltaminte  
 H Nubukvelourápoló spray  
 E Spray para suede



No.	ml	
72891	250	20

PL Kamizelka ostrzegawcza  
GB Reflective vest  
D Warnweste  
RUS Жилет безопасности

CZ Výstražná vesta  
RO Vestă de avertizare  
H Fényvisszaverő mellény  
E Chaleco reflectante

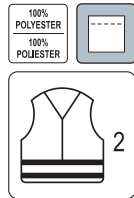

No.	size / rozmiar	model	
74660	L	VEST-O	100
74661	XL	VEST-O	100
74662	XXL	VEST-O	100
74663	XXXL	VEST-O	100

PL Kombinezon malarski  
GB Painting suit  
D Maleranzug  
RUS Малярный комбинезон

CZ Kombinéza malířská  
RO Salopetă pt. vopsitor  
H Festő kezeléslabas  
E Mono de pintor



No.	size / rozmiar	
74652	XXL	50

PL Kurtka przeciwdeszczowa  
GB Waterproof jacket  
D Regenjacke  
RUS Куртка-дождевик

CZ Bunda do deshtë  
RO Giacă impermeabilă  
H Vízhatlan dzseki  
E Chaqueta impermeable

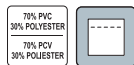

No.	size / rozmiar	
74626	L	20
74627	XXL	20
74628	XXXL	20

PL Kamizelka ostrzegawcza  
GB Reflective vest  
D Warnweste  
RUS Жилет безопасности

CZ Výstražná vesta  
RO Vestă de avertizare  
H Fényvisszaverő mellény  
E Chaleco reflectante

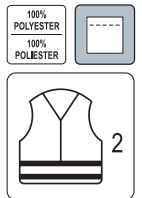

No.	size / rozmiar	model	
74664	L	VEST-G	100
74665	XL	VEST-G	100
74666	XXL	VEST-G	100
74667	XXXL	VEST-G	100

PL Kurtka przeciwdeszczowa  
GB Waterproof jacket  
D Regenjacke  
RUS Куртка-дождевик

CZ Bunda do deshtë  
RO Giacă impermeabilă  
H Vízhatlan dzseki  
E Chaqueta impermeable



No.	size / rozmiar	
74635	M	24
74636	L	24
74637	XL	24
74638	XXL	24
74639	XXXL	24

PL Płaszcz przeciwdeszczowy  
GB Raincoat  
D Regenmantel  
RUS Дождёвик  
CZ Pláštěnka  
RO Pelerina ploaie  
H Esőkabát  
E Impermeable

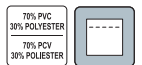

No.	size / rozmiar	
74631	XL	10
74632	XXL	10
74633	XXXL	10

**PL** Komplet przeciwdeszczowy moro  
**GB** Rain suit military style  
**D** Regenbekleidung militärischen Stil  
**RUS** Дождь костюмы военный стиль

**CZ** Oblek maskáčový do deště  
**RO** Îmbrăcămintă de ploaie camuflaj  
**H** Eső ruházat  
**E** Ropa de lluvia camo

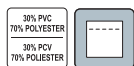

No.	size / rozmiar	
74646	L	20
74647	XXL	20

**PL** Ubranie robocze  
**GB** Working clothes  
**D** Arbeitskleidung  
**RUS** Рабочая одежда

**CZ** Pracovní oděv  
**RO** Haine de lucru  
**H** Munkaruha  
**E** Ropa de trabajo



No.	size / rozmiar	model	
74220	S	EBRO	24
74221	M	EBRO	24
74222	L	EBRO	24
74223	XL	EBRO	24
74224	XXL	EBRO	24

**PL** Spodnie ogrodnicze  
**GB** Garden trousers  
**D** Gartenhosen  
**RUS** Брюки садовые  
**CZ** Zahradnické kalhoty  
**RO** Pantaloni pt. grădinarit  
**H** Kertész nadrág  
**E** Pantalón de jardinería



No.	size / rozmiar	
72900	S	10
72901	M	10
72902	L	10
72903	XL	10



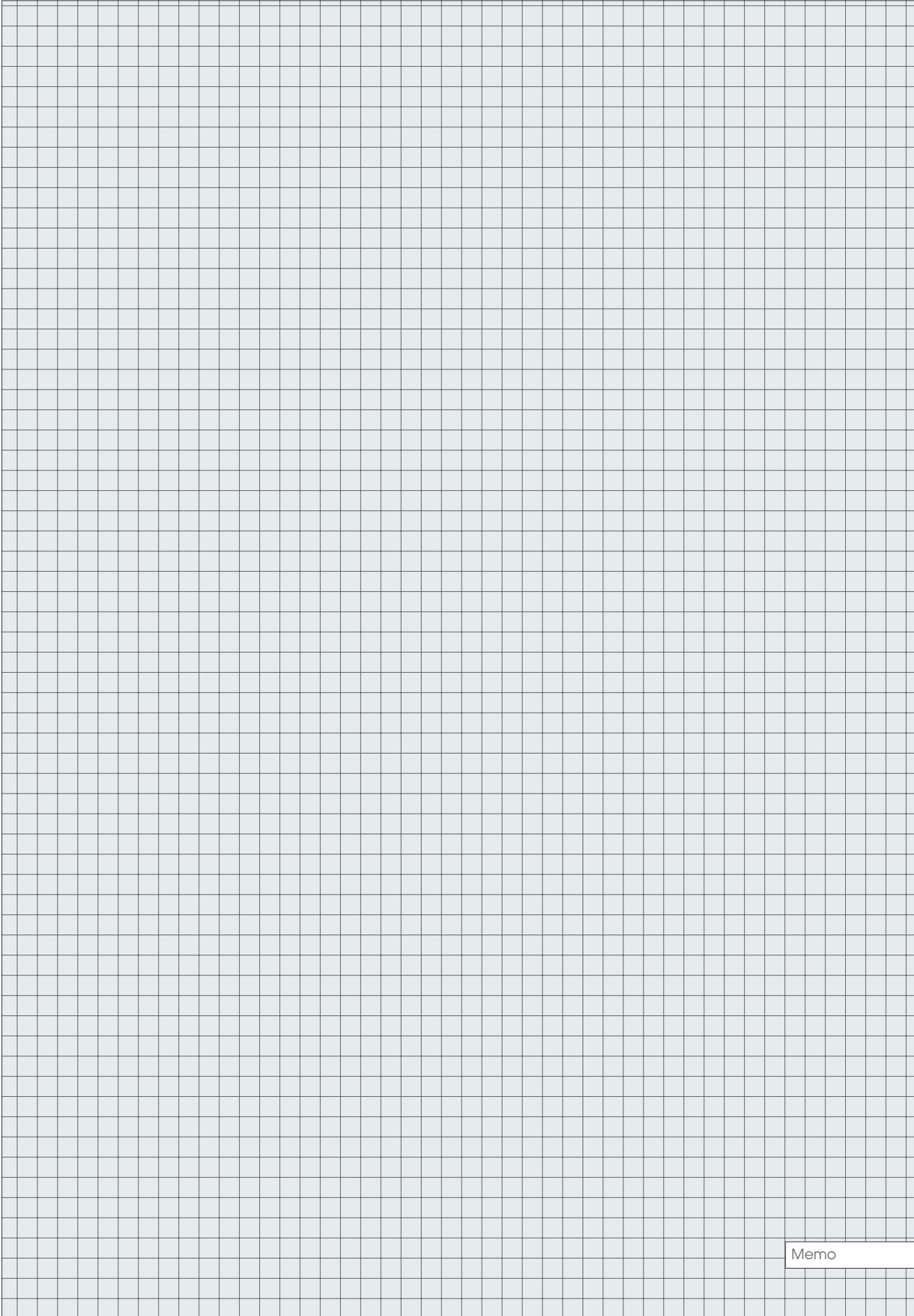

Memo

22

Electric products  
Artykuły elektryczne



**Extension cords & cable reels**  
**Przedłużacze listwowe**  
**i bębnowe**

318-319

**Extension cords French type**

Przedłużacze elektryczne z uziemieniem..... 318

**Extension cords**

Przedłużacze elektryczne bez uziemienia..... 318

**Christmas tree extension cables**

Przedłużacze choinkowe..... 319

**Cable reels French type**

Przedłużacze bębnowe z uziemieniem..... 319

**Adaptors**  
**Rozgałęźniki**

319-320

**Lamps**  
**Lampy**

320-326

**Halogen projectors**

Lampy halogenowe..... 320

**Halogen bulbs**

Żarniki do lamp halogenowych..... 321

**LED floodlights**

Naświetlacze LED..... 321

**Workshop lamps**

Lampy warsztatowe..... 322

**LED flashlights**

Latarki diodowe..... 325

**Bicycle lamps**

Lampy rowerowe..... 325

PL Przedłużacz elektryczny z uziemieniem  
 GB Cord extension with earthing  
 D Tischsteckdose bolzenanschl  
 RUS Удлинитель электрический с заземлением

CZ Elektrický prodloužovač  
 RO Prelungitor electric  
 H Elektromos hosszabító  
 E Extensión electr.



No.	L (m)	☺	type	📦
72500	1.5	3	E	12/48
72501	1.5	4	E	12/48
72504	3.0	3	E	12/48
72505	3.0	4	E	12/48
72506	3.0	5	E	12/48
72508	5.0	3	E	12/48
72509	5.0	4	E	12/48
72510	5.0	5	E	12/48

PL Przedłużacz elektryczny bez uziemienia  
 GB Cord extension without earthing  
 D Tischsteckdose ohne nulleitung  
 RUS Удлинитель электрический без заземления  
 CZ Elektrický prodloužovač  
 RO Prelungitor electric  
 H Elektromos hosszabító  
 E Extensión electr.



No.	L (m)	☺	type	📦
72484	1.5	3	C	12/48
72486	1.5	4	C	12/48
72489	3.0	3	C	12/48
72490	3.0	4	C	12/48
72493	5.0	3	C	12/48
72494	5.0	4	C	12/48

PL Przedłużacz elektryczny z uziemieniem  
 GB Cord extension with earthing  
 D Tischsteckdose bolzenanschl  
 RUS Удлинитель электрический с заземлением

CZ Elektrický prodloužovač  
 RO Prelungitor electric  
 H Elektromos hosszabító  
 E Extensión electr.



No.	L (m)	☺	type	📦
72625	1.5	3	E	12/48
72626	3.0	3	E	12/48
72627	5.0	3	E	12/48
72630	1.5	4	E	12/48
72631	3.0	4	E	12/48
72632	5.0	4	E	12/48

PL Przedłużacz elektryczny z uziemieniem  
 GB Cord extension with earthing  
 D Tischsteckdose bolzenanschl  
 RUS Удлинитель электрический с заземлением

CZ Elektrický prodloužovač  
 RO Prelungitor electric  
 H Elektromos hosszabító  
 E Extensión electr.



No.	L (m)	☺	type	📦
72615	1.5	3	E	12/48
72616	3.0	3	E	12/48
72617	5.0	3	E	12/48
72620	1.5	4	E	12/48
72621	3.0	4	E	12/48
72622	5.0	4	E	12/48

PL Przedłużacz elektryczny z wyłącznikiem  
 GB Cord extension with switch  
 D Tischsteckdose  
 RUS Удлинитель электрический с выключателем  
 CZ Elektrický prodloužovač  
 RO Prelungitor electric  
 H Elektromos hosszabító  
 E Extensión para arbol de navidad verde

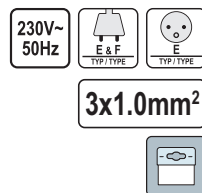

No.	L (m)	☺	type	📦
72524	1.5	3	E	12/48
72525	1.5	4	E	12/48
72526	1.5	5	E	12/48
72527	1.5	6	E	12/48
72528	3.0	3	E	12/48
72529	3.0	4	E	12/48
72530	3.0	5	E	12/48
72531	3.0	6	E	12/48
72532	5.0	3	E	12/48
72533	5.0	4	E	12/48
72534	5.0	5	E	12/48
72535	5.0	6	E	12/48

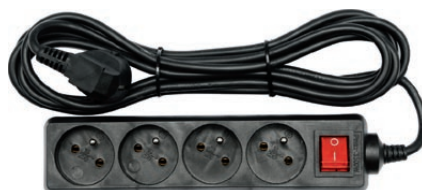



PL Przedłużacz  
GB Garden extension cable  
D Gartenverlängerungskabel  
RUS Электроудлинитель

CZ Prodlužovací kabel zahradní  
RO Prelungitor electric  
H Kerti hosszabbító  
E Cable de extensión para jardín

230V~  
50Hz  
IP20  
2x1.0mm<sup>2</sup>



No.	L (m)	
82671	10	10
82673	20	10
82675	30	5
82677	40	5

PL Przedłużacz zielony  
GB Christmas tree extension cable  
D Christbaum Verlängerungskabel  
RUS Удлинитель

CZ Elektrický prodloužovač  
RO Prelungitor electric  
H Elektromos hosszabbító  
E Extensión para árbol de Navidad verde

2x0.75mm<sup>2</sup>  
230V~  
50Hz

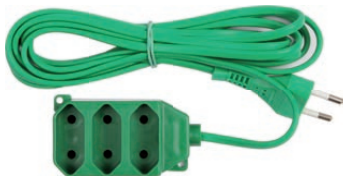

No.	L (m)	
72451	3	10
72452	5	10

PL Przedłużacz bębnowy  
GB Cable reel  
D Kabeltrommel  
RUS Удлинитель на катушке  
CZ Bubenový prodloužovač  
RO Prelungitor pe tambur  
H Kábeldob  
E Cable de prolongación de tambor



230V~  
50Hz



No.	L (m)	wire gauge / průřez / przewodu (mm <sup>2</sup> )		type	
82682	25	3x1.0	4	E	2
82684	40	3x1.0	4	E	2
82685	50	3x1.5	4	E	2

PL Rozgałęźnik  
GB Adapter  
D Abzweigung  
RUS Разветвитель

CZ Rozdvojka  
RO Splitter  
H Oszlő  
E Enchufe múltiple

230V~  
50Hz  
16A



No.		type	
72404	2	E	100

PL Przedłużacz  
GB Garden extension cable  
D Gartenverlängerungskabel  
RUS Электроудлинитель

CZ Prodlužovací kabel zahradní  
RO Prelungitor electric  
H Kerti hosszabbító  
E Cable de extensión para jardín

230V~  
50Hz  
10m  
2x1.0mm<sup>2</sup>



No.	L (m)	
72455	10	10

PL Przedłużacz związany  
GB Cable reel  
D Kabeltrommel bolzenanschl  
RUS Удлинитель электрический  
CZ Bubenový prodloužovač  
RO Prelungitor pe tambur  
H Kábeldob  
E Extensión electr.



PVC



No.	L (m)	wire gauge / průřez / przewodu (mm <sup>2</sup> )		type	
72570	15	3x1.0	4	E	4
72572	25	3x1.0	4	E	4
72573	30	3x1.5	4	E	4

PL Przedłużacz bębnowy, silowy  
GB Cable reel  
D Kabeltrommel  
RUS Удлинитель силовой на катушке  
CZ Bubenový prodloužovač  
RO Prelungitor pe tambur  
H Kábeldob  
E Cable de prolongación de tambor



5x1.5mm<sup>2</sup>  
230V~  
50Hz  
400V~  
50Hz  
IP44



No.	L (m)	A	
82687	20	16	1

PL Rozgałęźnik  
GB Adapter  
D Abzweigung  
RUS Разветвитель

CZ Rozdvojka  
RO Splitter  
H Oszlő  
E Enchufe múltiple

230V~  
50Hz  
16A



No.		type	
72407	3	E	100

- PL Rozgałęźnik  
 GB Adapter  
 D Abzweigung  
 RUS Разветвитель
- CZ Rozdvojka  
 RO Splitter  
 H Oszlő  
 E Enchufe múltiple



No.	⏻	type	📦
72400	2	C&E&F	200
72401	3	C&E&F	100
72402	4	C&E&F	100

- PL Lampa halogenowa  
 GB Halogen lamp  
 D Halogenstrahler  
 RUS Галогенная фара-прожектор  
 CZ Halogenové svítilno  
 RO Lampa cu halogen  
 H Halogén lámpa  
 E Lampara de halogeno



No.	W	📦
82795	120	18
82796	400	12

- PL Lampa halogenowa przenośna  
 GB Portable halogen projector  
 D Halogenstrahler  
 RUS Проектор галогенный переносный  
 CZ Halogenové svítilno přenosné  
 RO Lampa cu halogen mobilă  
 H Hordozható halogén lámpa  
 E Lampara de halogeno portatil



No.	W	cable / kabel (m)	📦
82788	120	1.7	12
82789	400	1.7	8

- PL Lampa halogenowa  
 GB Halogen lamp  
 D Halogenstrahler  
 RUS Галогенная фара-прожектор  
 CZ Halogenové svítilno  
 RO Lampa cu halogen  
 H Halogén lámpa  
 E Lampara de halogeno



No.	W	📦
82790	120	24
82791	400	16

- PL Lampa halogenowa  
 GB Halogen lamp  
 D Halogenstrahler  
 RUS Галогенная фара-прожектор  
 CZ Halogenové svítilno  
 RO Lampa cu halogen  
 H Halogén lámpa  
 E Lampara de halogeno



No.	W	📦
82798	400	12

- PL Lampa halogenowa na stojaku  
 GB Halogen projector on tripod  
 D Halogenstrahler mit Stativ  
 RUS Проектор галогенный на штативе  
 CZ Halogenové svítilno na stojanu  
 RO Lampa cu halogen pe stativ  
 H Állványos halogén lámpa  
 E Lampara de halogeno sobre estante



No.	W	📦
82786	400	4

- PL Lampa halogenowa na stojaku
- GB Halogen projector on tripod
- D Halogenstrahler mit Stativ
- RUS Проектор галогенный на штативе
- CZ Halogenové svítilno na stojanu
- RO Lampa cu halogen pe stativ
- H Állványos halogén lámpa
- E Lampara de halogeno sobre estante

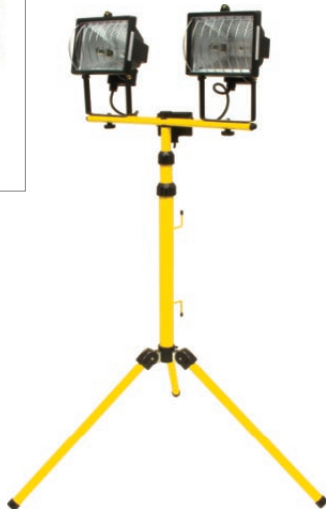

2  
PCS

230V~  
50Hz

0.827m

IP54

3.0m

- PL Żarniki do lamp halogenowych
- GB Halogen projector bulbs
- D Halogenstab
- RUS Галогенная трубка

- CZ Žárovka do halogenové lampy
- RO Bec cu halogen pt. proiector
- H Halogén lámpaizzó
- E Filamentos de bombillas halogenas

2  
PCS

R7s



No.	W	lumens	h	
82771	120	2200	1000	50/200
82772	400	8600	1000	50/200

- PL LED lamp
- GB Diodenscheinwerfer
- D Reflektor diodowy
- RUS Светодиодный прожектор

- CZ LED reflektor
- RO Reflector diodă
- H Diodas reflektor
- E Reflector de diodos

10W 6000 K

800  
lm 230V~  
50Hz

25000 h IP65



No.	W	lumens	h	
82841	10	800	25000	12

- PL LED lamp
- GB Diodenscheinwerfer
- D Reflektor diodowy
- RUS Светодиодный прожектор

- CZ LED reflektor
- RO Reflector diodă
- H Diodas reflektor
- E Reflector de diodos

30W 6000 K

2400  
lm 230V~  
50Hz

25000 h IP65



No.	W	lumens	h	
82843	30	2400	25000	12

- PL LED lamp
- GB Diodenscheinwerfer
- D Reflektor diodowy
- RUS Светодиодный прожектор



20W 6000 K

1600  
lm 230V~  
50Hz

25000 h IP65



No.	W	lumens	h	
82842	20	1600	25000	12

- PL LED lamp
- GB Diodenscheinwerfer
- D Reflektor diodowy
- RUS Светодиодный прожектор

- CZ LED reflektor
- RO Reflector diodă
- H Diodas reflektor
- E Reflector de diodos

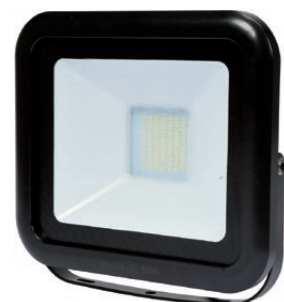

50W 6000 K

4000  
lm 230V~  
50Hz

25000 h IP65



No.	W	lumens	h	
82844	50	4000	25000	12

- PL LED lamp with motion detector
- GB Diodenscheinwerfer mit Bewegungsmelder
- D Reflektor diodowy z czujnikiem ruchu
- RUS Светодиодный прожектор с датчиком движения
- CZ LED reflektor se snímačem pohybu
- RO Reflector diodă cu senzor de mișcare
- H Diódás reflektor mozgásérzékelővel
- E Reflector de diodos con sensor de movimiento

10W	6000 K
800 lm	230V~50Hz
25000 h	IP54
10m	



**SMD LED**



No.	W	lumens	h	
82845	10	800	25000	12

- PL LED lamp with motion detector
- GB Diodenscheinwerfer mit Bewegungsmelder
- D Reflektor diodowy z czujnikiem ruchu
- RUS Светодиодный прожектор с датчиком движения
- CZ LED reflektor se snímačem pohybu
- RO Reflector diodă cu senzor de mișcare
- H Diódás reflektor mozgásérzékelővel
- E Reflector de diodos con sensor de movimiento

30W	6000 K
2400 lm	230V~50Hz
25000 h	IP54
10m	



**SMD LED**



No.	W	lumens	h	
82847	30	2400	25000	12

- PL Reflektor diodowy
- GB LED lamp
- D Diodenscheinwerfer
- RUS Светодиодный прожектор
- CZ LED reflektor
- RO Reflector diodă
- H Diódás reflektor
- E Reflector de diodos

**LED**

8W	130 LED
585 lm	230V~50Hz
30 000-50 000 h	IP54



No.	W	led / diody	
82800	8	130	16

- PL LED lamp with motion detector
- GB Diodenscheinwerfer mit Bewegungsmelder
- D Reflektor diodowy z czujnikiem ruchu
- RUS Светодиодный прожектор с датчиком движения
- CZ LED reflektor se snímačem pohybu
- RO Reflector diodă cu senzor de mișcare
- H Diódás reflektor mozgásérzékelővel
- E Reflector de diodos con sensor de movimiento

20W	6000 K
1600 lm	230V~50Hz
25000 h	IP54
10m	



**SMD LED**



No.	W	lumens	h	
82846	20	1600	25000	12

- PL LED lamp with motion detector
- GB Diodenscheinwerfer mit Bewegungsmelder
- D Reflektor diodowy z czujnikiem ruchu
- RUS Светодиодный прожектор с датчиком движения
- CZ LED reflektor se snímačem pohybu
- RO Reflector diodă cu senzor de mișcare
- H Diódás reflektor mozgásérzékelővel
- E Reflector de diodos con sensor de movimiento

50W	6000 K
4000 lm	230V~50Hz
25000 h	IP54
10m	



**SMD LED**



No.	W	lumens	h	
82848	50	4000	25000	12

- PL Diodowa lampa bezprzewodowa
- GB Rechargeable work lamp
- D Led Werkstattlampe
- RUS Светодиодная беспроводная лампа
- CZ Montážní lampa diodová bezprívodová
- RO Lampa cu led fara cablu
- H Ledlámpa
- E Lámpara inalámbrica de diodos

12 LED	200 lm	CHARGING TIME CZAS ŁADOWANIA 4 h	WORK TIME CZAS PRACY 4.5 h
12V 2000mAh	230V~50Hz	12V BATTERY CHARGER ŁADOWNIK	HOOK HAK



**SMD LED**



No.	LED	mAh	
82728	12	2000	20

- PL Diodowa lampa bezprzewodowa
- GB Rechargeable work lamp
- D Led Werkstattlampe
- RUS Светодиодная беспроводная лампа
- CZ Montážní lampa diodová bezpřívodová
- RO Lampa cu led fara cablu
- H Ledlámpa
- E Lámpara inalámbrica de diodos

<b>3W</b>	<b>200 Im</b>	<b>3.7V</b> 2000mAh Li-Ion	<b>12V</b> BATTERY CHARGER LADOWARKA	
<b>230V~50Hz</b> BATTERY CHARGER LADOWARKA		<b>4 h</b> WORK TIME CZAS PRACY	<b>4 h</b> CHARGING TIME CZAS LADOWANIA	



No.	W	mAh	
82719	3	2000	20

- PL Lampa robocza LED
- GB LED work light
- D LED Werkstattlampe
- RUS Светодиодный светильник для мастерской
- CZ Ruční svítidla LED
- RO Lampa portabila cu LED
- H LED lámpa
- E Lámpara de taller LED

<b>230V~50Hz</b>	<b>280 Im</b>	<b>16 LED</b>
	<b>4.5 W</b>	<b>5.0m</b>

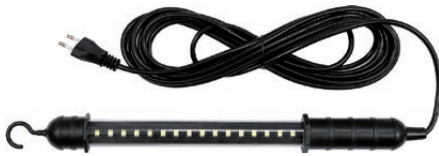

No.	W	LED	
82699	4.5	16	10/20

- PL Lampa warsztatowa
- GB Work light
- D Werkstattlampe
- RUS Лампа-переноска
- CZ Pracovní lampa
- RO Lampă pt. atelier
- H Szerelőlámpa
- E Lampara de taller

<b>230V~50Hz</b>	
<b>11W</b>	<b>5.0m</b>



No.	W	type	
82705	11	„EFFECT”	10

- PL Lampa warsztatowa
- GB Work light
- D Werkstattlampe
- RUS Лампа-переноска
- CZ Pracovní lampa
- RO Lampă pt. atelier
- H Szerelőlámpa
- E Lampara de taller

<b>230V~50Hz</b>		<b>60W</b>	<b>5.0m</b>
------------------	--	------------	-------------



No.	W	type	
82715	60	„PLASTIC”	10

- PL Diodowa lampa bezprzewodowa
- GB Rechargeable work lamp
- D Led Werkstattlampe
- RUS Светодиодная беспроводная лампа
- CZ Montážní lampa diodová bezpřívodová
- RO Lampa cu led fara cablu
- H Ledlámpa
- E Lámpara inalámbrica de diodos

<b>36 LED</b>	<b>3.7V</b> 1200mAh Li-Ion
<b>230V~50Hz</b> BATTERY CHARGER LADOWARKA	<b>12V</b> BATTERY CHARGER LADOWARKA
<b>4 h</b> CHARGING TIME CZAS LADOWANIA	<b>4 h</b> WORK TIME CZAS PRACY

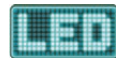

No.	LED	mAh	
82720	36	500	10/20

- PL Lampa robocza LED
- GB LED work light
- D LED Werkstattlampe
- RUS Светодиодный светильник для мастерской
- CZ Ruční svítidla LED
- RO Lampa portabila cu LED
- H LED lámpa
- E Lámpara de taller LED

<b>230V~50Hz</b>	<b>400 Im</b>	<b>24 LED</b>
	<b>4.5 W</b>	<b>5.0m</b>



No.	W	LED	
82706	4.5	24	10/20

- PL Lampa warsztatowa
- GB Work light
- D Werkstattlampe
- RUS Лампа-переноска
- CZ Pracovní lampa
- RO Lampă pt. atelier
- H Szerelőlámpa
- E Lampara de taller

<b>230V~50Hz</b>		<b>100 W</b>	<b>5.0m</b>
------------------	--	--------------	-------------



No.	W	type	
82713	100	„PRACTIC”	10

- PL Lampa warsztatowa
- GB Work light
- D Werkstattlampe
- RUS Лампа-переноска
- CZ Pracovní lampa
- RO Lampă pt. atelier
- H Szerelőlámpa
- E Lampara de taller

<b>230V~50Hz</b>		<b>60W</b>	<b>5.0m</b>
------------------	--	------------	-------------



No.	W	type	
82712	60	„BASKET”	10

- PL Lampa warsztatowa  
GB Work light  
D Werkstattlampe  
RUS Лампа-переноска
- CZ Pracovní lampa  
RO Lampă pt. atelier  
H Szerelőlámpa  
E Lámpara de taller

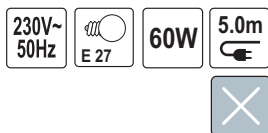

No.	W	type	
82714	60	„CLASSIC“	10

- PL Lampa robocza LED  
GB LED work light  
D LED Handleuchte  
RUS Светодиодный светильник для мастерской
- CZ Ruční svítidla LED  
RO Lampa portabilă cu LED  
H LED lámpa  
E Lámpara de taller LED



**COB**  
LED



**VOREL**

No.	LED	battery / bateria	
82724	COB	3xAAA	12/48

- PL Lampa robocza LED  
GB LED work light  
D LED Handleuchte  
RUS Светодиодный светильник для мастерской
- CZ Ruční svítidla LED  
RO Lampa portabilă cu LED  
H LED lámpa  
E Lámpara de taller LED



**SMD**  
LED



**VOREL**

No.	LED	battery / bateria	
82731	24+3	3xAAA	12/48

- PL Lampa robocza LED  
GB LED work light  
D LED Handleuchte  
RUS Светодиодный светильник для мастерской
- CZ Ruční svítidla LED  
RO Lampa portabilă cu LED  
H LED lámpa  
E Lámpara de taller LED



**LED**



**VOREL**

No.	LED	battery / bateria	
82735	36+1	4xAAA	12/48

- PL Lampa warsztatowa  
GB Work light  
D Werkstattlampe  
RUS Лампа-переноска
- CZ Pracovní lampa  
RO Lampă pt. atelier  
H Szerelőlámpa  
E Lámpara de taller



No.	W	type	
82716	60	„GUMMI“	10
82717	100	„GUMMI“	10

- PL Lampa robocza LED  
GB LED work light  
D LED Handleuchte  
RUS Светодиодный светильник для мастерской
- CZ Ruční svítidla LED  
RO Lampa portabilă cu LED  
H LED lámpa  
E Lámpara de taller LED



**SMD**  
LED



**VOREL**

No.	LED	battery / bateria	
82730	20+3	3xAAA	12/48

- PL Lampa robocza LED  
GB LED work light  
D LED Handleuchte  
RUS Светодиодный светильник для мастерской
- CZ Ruční svítidla LED  
RO Lampa portabilă cu LED  
H LED lámpa  
E Lámpara de taller LED

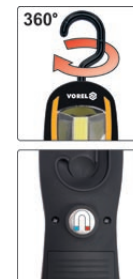

**COB**  
LED

**VOREL**

No.	battery / bateria	
82726	3xAAA	12/48

- PL Lampa robocza LED  
GB LED work light  
D LED Handleuchte  
RUS Светодиодный светильник для мастерской
- CZ Ruční svítidla LED  
RO Lampa portabilă cu LED  
H LED lámpa  
E Lámpara de taller LED



**SMD**  
LED

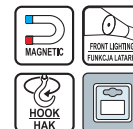

**VOREL**

No.	LED	battery / bateria	
82742	6+1	3xAAA	12/48

- PL Chwytnak teleskopowy LED
- GB LED magnetic pick up tool
- D LED magnet heber
- RUS Захват магнитный телескопический с подсветкой
- CZ Patka magnetická teleskopická LED
- RO Telescop magnetic cu LED
- H LED felszedő mágnes teleszkópos nyéllel
- E Herramienta para levantar, telescópica, con LED



**3 LED**

17-56.5 cm  
TELESCOPIC HANDLE  
TELESKOPOWY UCHWYT

4xLR44  
INCLUDED  
W ZESTAWIE

**LED**



No.	LED	battery / bateria	
78405	3	3xAAA	12/48

- PL Diodowa latarka czolowa
- GB Led work lamp
- D Stirntaschenlampe
- RUS Налобный светодиодный фонарь
- CZ Led montážní lampa - čelovka
- RO Lampa cu led
- H Led fejlámpa
- E Linterna de diodo

**LED**

**8 LED**

3x1.5V (AAA)  
NOT INCLUDED  
NIE ZALĄCZONE



No.	battery / bateria	
88670	3xAAA	12/72

- PL Diodowa latarka czolowa
- GB Led work lamp
- D Stirntaschenlampe
- RUS Налобный светодиодный фонарь
- CZ Led montážní lampa - čelovka
- RO Lampa cu led
- H Led fejlámpa
- E Linterna de diodo

**POWER LED**

**1 LED**

**1 W**

3 LIGHTNING MODES  
3 TRYBY SWIECENIA

3x1.5V (AAA)  
NOT INCLUDED  
NIE ZALĄCZONE



No.	battery / bateria	
88672	3xAAA	12/60

- PL Diodowa latarka czolowa
- GB Led work lamp
- D Stirntaschenlampe
- RUS Налобный светодиодный фонарь
- CZ Led montážní lampa - čelovka
- RO Lampa cu led
- H Led fejlámpa
- E Linterna de diodo

**POWER LED**

**1 LED**

**1 W**

3 LIGHTNING MODES  
3 TRYBY SWIECENIA

3x1.5V (AAA)  
NOT INCLUDED  
NIE ZALĄCZONE



No.	battery / bateria	
88674	3xAAA	12/48

- PL Latarka LED
- GB LED Flashlight
- D LED-Taschenlampe
- RUS Светодиодный фонарь
- CZ LED svítlna
- RO Lanterna cu LED
- H LED elemlámpa
- E Linterna LED

**POWER LED**

**3W**

**150 Im**

3x1.5V (AAA)  
NOT INCLUDED  
NIE ZALĄCZONE

**ZOOM**



No.	W	lumens	battery / bateria	
88550	3	150	3xAAA	12/48

- PL Diodowa latarka czolowa
- GB Led work lamp
- D Stirntaschenlampe
- RUS Налобный светодиодный фонарь
- CZ Led montážní lampa - čelovka
- RO Lampa cu led
- H Led fejlámpa
- E Linterna de diodo

**LED**

**17 LED**

3x1.5V (AAA)  
NOT INCLUDED  
NIE ZALĄCZONE



No.	battery / bateria	
88671	3xAAA	12/72

- PL Diodowa latarka czolowa
- GB Led work lamp
- D Stirntaschenlampe
- RUS Налобный светодиодный фонарь
- CZ Led montážní lampa - čelovka
- RO Lampa cu led
- H Led fejlámpa
- E Linterna de diodo

**POWER LED**

**1 LED**

**1 W**

3 LIGHTNING MODES  
3 TRYBY SWIECENIA

3x1.5V (AAA)  
NOT INCLUDED  
NIE ZALĄCZONE



No.	battery / bateria	
88673	3xAAA	12/48

- PL Lampa czolowa LED
- GB LED headlamp
- D LED Kopflampe
- RUS Налобный светодиодный фонарь
- CZ Čelová lampa LED
- RO Lanterna cu LED pt. cap
- H LED fejlámpa
- E Lámpara LED de Cabeza

**1+2 LED**

**100 Im**

3x1.5V (AAA)  
NOT INCLUDED  
NIE ZALĄCZONE



No.	battery / bateria	
88675	3xAAA	12/48

- PL Lampa czołowa LED  
 GB LED headlamp  
 D LED Kopflampe  
 RUS Налобный светодиодный фонарь
- CZ Čelová lampa LED  
 RO Lanterna cu LED pt. cap  
 H LED fejlámpa  
 E Lámpara LED de Cabeza

**COB**  
**LED**



**3W** **150**  
**Im**

3x1.5V (AAA)  
 NOT INCLUDED  
 NE ZALAGAZNÉ



No.	battery / bateria	
88676	3xAAA	12/48

- PL LED bike light set  
 GB Fahrrad-Beleuchtungsset LED  
 D Zestaw lamp rowerowych LED  
 RUS Набор светодиодных велосипедных фонарей
- CZ Set LED osvětlení na kolo  
 RO Set lanterna bicicleta LED  
 H LED kerékpár lámpa szett  
 E Juego de luces LED para bicicleta

**POWER**  
**LED**



**5** **2x1.5V**  
**LED** **(AAA)**  
 NOT INCLUDED  
 NE ZALAGAZNÉ

**3W** **150**  
**Im**

3x1.5V (AAA)  
 NOT INCLUDED  
 NE ZALAGAZNÉ

**ZOOM**



No.	battery / bateria	
88422	3xAAA / 2xAAA	12/48

- PL LED front bike light  
 GB Fahrrad Frontscheinwerfer LED  
 D Lampa rowerowa przednia LED  
 RUS Светодиодный фонарик для велосипеда
- CZ Přední světla LED na kolo  
 RO Lanterna pt. bicicleta LED  
 H LED-es első kerékpár lámpa  
 E Linterna LED frontal para bicicleta

**POWER**  
**LED**



**3W** **150**  
**Im**

3x1.5V (AAA)  
 NOT INCLUDED  
 NE ZALAGAZNÉ

**ZOOM**



No.	battery / bateria	
88411	3xAAA	12/48

- PL LED bike light set  
 GB Fahrrad-Beleuchtungsset LED  
 D Zestaw lamp rowerowych LED  
 RUS Набор светодиодных велосипедных фонарей
- CZ Set LED osvětlení na kolo  
 RO Set lanterna bicicleta LED  
 H LED kerékpár lámpa szett  
 E Juego de luces LED para bicicleta

**POWER**  
**LED**



**1W** **3x1.5V**  
**5** **(AAA)**  
**LED** NOT INCLUDED  
 NE ZALAGAZNÉ

**2x1.5V** **(AAA)**  
 NOT INCLUDED  
 NE ZALAGAZNÉ



No.	battery / bateria	
88421	3xAAA / 2xAAA	12/120



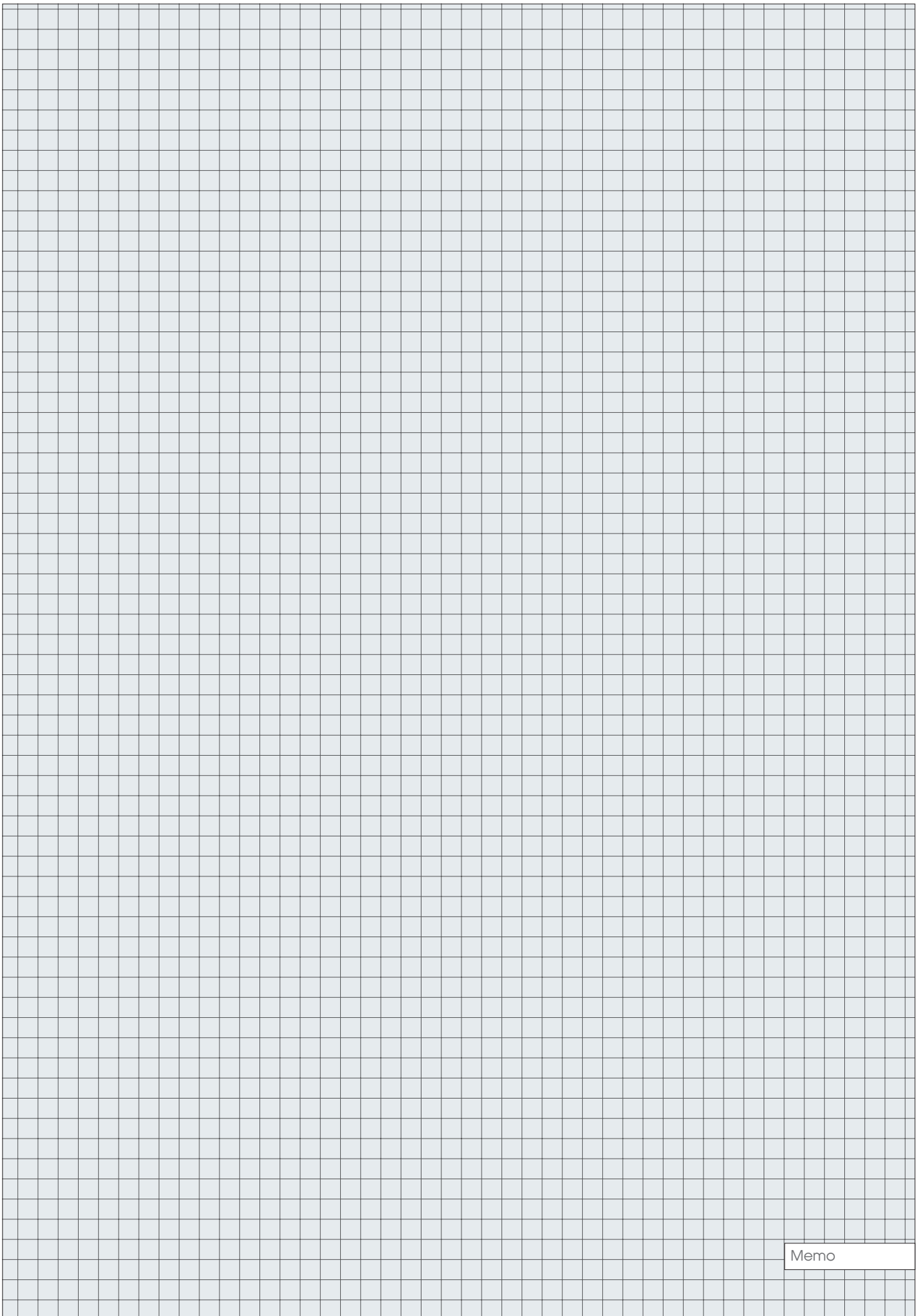

Memo

# 23

## Garden tools & power tools Narzędzia i elektronarzędzia ogrodowe



## Watering program Program wodny



330-343

### Hose connectors, male connectors, couplings, hose menders

Złącza, nypły, łączniki, rozgałęziacze, reparatory..... 330

### Water timers

Sterowniki nawadniania..... 334

### Hose nozzles (sprinklers) & sets

Zraszacze i zestawy..... 334

### Garden hoses

Wężę ogrodowe..... 340

### Garden hose carts & holders

Wózki i stojaki na wężę ogrodowe..... 340

### Pumps

Pompy..... 341

## Pruners & shears Sekatory i nożyce ogrodowe



343-347

### Pruners

Sekatory..... 343

### Lopping shears

Sekatory do gałęzi..... 345

### Leverage tree pruners

Sekatory gąsienicowe..... 346

### Hedge shears

Nożyce do żywopłotu..... 346

### Grass shears

Nożyce do trawy..... 347

## Garden saws & blades Piły ogrodowe i brzeszczoty



347-348

## Axes & splitting wedges Siekiry i kliny do drewna



348-350

## Hand tools Narzędzia ręczne



350-364

### Small garden tools

Małe narzędzia ogrodowe..... 350

### Big garden tools

Duże narzędzia ogrodowe..... 353

### Handles

Trzonki..... 362

## Sprayers & accessories Opryskiwacze i akcesoria



364-366

## Gasoline garden tools, power tools & accessories Ogrodowe narzędzia spalinowe, elektronarzędzia i akcesoria



366-370

### Grass trimmers

Wykaszarki..... 366

### Hedge trimmers

Nożyce do trawy i żywopłotu..... 367

### Accessories

Akcesoria..... 367

## Health & safety products Artykuły BHP



370-375

### Gloves

Rękawice..... 370

### Rain boots

Kalosze..... 371

### Knee pads

Nakolanniki..... 372

### Head, hearing & eyesight protection

Ochrona głowy, słuchu i wzroku..... 373

### Working clothes

Odzież robocza..... 375

## Garden accessories Akcesoria ogrodowe

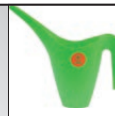

375-378

## BBQ grills & accessories Grille i akcesoria



378-380

### Gas BBQ grills

Grille gazowe..... 378

### Charcoal BBQ grills

Grille węglowe..... 379

### Accessories

Akcesoria..... 380

PL Złącze  
GB Hose connector  
D Universal  
Schnellschlauchkupplung  
RUS Соединитель

CZ Rychlospojka  
RO Mufă pt. pistol  
H Fitting  
E Junta estandar

1/2"  
12.5mm  
3/4"  
19mm

ABS



No.	size / rozmiar	packing	
89221	1/2" (12.5 mm)		150/600
89222	1/2" (12.5 mm)		24/288
89223	3/4" (19.0 mm)		60/240
89224	3/4" (19.0 mm)		24/288

PL Złącze  
GB Hose connector  
D Universal  
Schnellschlauchkupplung  
RUS Соединитель

CZ Rychlospojka  
RO Mufă pt. pistol  
H Fitting  
E Junta estandar

1/2"  
12.5mm  
3/4"  
19mm

ABS

STOP



No.	size / rozmiar	packing	
89225	1/2" (12.5 mm)		150/600
89226	1/2" (12.5 mm)		24/288
89227	3/4" (19.0 mm)		60/240
89228	3/4" (19.0 mm)		24/288

PL Złącze mosiężne  
GB Brass hose connector  
D Schlauch-Schnellkupplung  
RUS Быстросъемная муфта

CZ Rychlospojka  
RO Manșon de îmbinare  
H Csatlakozó  
E Conexión

1/2"  
12.5mm  
3/4"  
19mm  
BRASS  
MOSIADZ



No.	size / rozmiar	
89100	1/2" (12.5 mm)	48
89102	3/4" (19.0 mm)	48

PL Złącze mosiężne stop  
GB Brass hose connector  
D Schlauch-Schnellkupplung  
RUS Быстросъемная муфта

CZ Rychlospojka  
RO Manșon de îmbinare  
H Csatlakozó  
E Conexión

1/2"  
12.5mm  
3/4"  
19mm  
BRASS  
MOSIADZ  
STOP



No.	size / rozmiar	
89101	1/2" (12.5 mm)	48
89103	3/4" (19.0 mm)	48

PL Złącze  
GB Hose connector  
D Universal  
Schnellschlauchkupplung  
RUS Соединитель

CZ Rychlospojka  
RO Mufă pt. pistol  
H Fitting  
E Junta estandar

1/2"  
12.5mm  
3/4"  
19mm

ABS



No.	size / rozmiar	
89001	1/2" (12.5 mm)	30/240
89002	3/4" (19.0 mm)	30/240

PL Złącze  
GB Hose connector  
D Universal  
Schnellschlauchkupplung  
RUS Соединитель

CZ Rychlospojka  
RO Mufă pt. pistol  
H Fitting  
E Junta estandar

1/2"  
12.5mm  
3/4"  
19mm  
ABS  
STOP



No.	size / rozmiar	
89003	1/2" (12.5 mm)	30/240
89004	3/4" (19.0 mm)	30/240

PL Złącze mosiężne  
GB Brass hose connector  
D Schlauch-Schnellkupplung  
RUS Быстросъемная муфта

CZ Rychlospojka  
RO Manșon de îmbinare  
H Csatlakozó  
E Conexión

1/2"  
12.5mm  
3/4"  
19mm  
BRASS  
MOSIADZ



No.	size / rozmiar	
89070	1/2" (12.5 mm)	12/48
89072	3/4" (19.0 mm)	12/48

PL Złącze mosiężne stop  
GB Brass hose connector  
D Schlauch-Schnellkupplung  
RUS Быстросъемная муфта

CZ Rychlospojka  
RO Manșon de îmbinare  
H Csatlakozó  
E Conexión

1/2"  
12.5mm  
3/4"  
19mm  
BRASS  
MOSIADZ  
STOP



No.	size / rozmiar	
89071	1/2" (12.5 mm)	12/48
89073	3/4" (19.0 mm)	12/48

PL Reparatör do węzła  
GB Hose mender  
D Schlauchreparatur  
RUS Соединитель шлангов

CZ Opravka  
RO Mufă înădire  
H Gyorstoldó  
E Reparador para manguera

1/2"  
12.5mm  
3/4"  
19mm  
ABS



No.	size / rozmiar	packing	
89229	1/2" (12.5 mm)		60/240
89230	1/2" (12.5 mm)		24/288
89231	3/4" (19.0 mm)		60/240
89232	3/4" (19.0 mm)		24/288

PL Reparatör do węzła  
GB Hose mender  
D Schlauchreparaturstück  
RUS Соединитель шлангов

CZ Opravka  
RO Mufă înădire  
H Csatlakozó  
E Reparador para manguera

1/2"  
12.5mm  
3/4"  
19mm  
BRASS  
MOSIADZ



No.	size / rozmiar	
89104	1/2" (12.5 mm)	48
89105	3/4" (19.0 mm)	48

PL Reparatör do węzła  
GB Hose mender  
D Schlauchverbinder mit Reduktion  
RUS Соединитель шлангов

CZ Opravka  
RO Mufă înădire  
H Gyorstoldó  
E Reparador para manguera

1/2"  
12.5mm  
3/4"  
19mm  
ABS



No.	size / rozmiar	packing	
89233	3/4"; 1/2" (19.0; 12.5 mm)		60/240
89234	3/4"; 1/2" (19.0; 12.5 mm)		24/288

PL Przyłącze do kranu  
GB Snap-in tap adaptor  
D Wasserhahanschluß für Gartenschlauch  
RUS Адаптер внешний

CZ Šroubení  
RO Mufă pt. robinet cu filet interior  
H Tömlovég csaphoz  
E Tubuladura de grifo

1/2"  
12.5mm  
ABS



No.	size / rozmiar	
89253	1/2" (12.5 mm)	24/240

PL Reparatör do węzła  
GB Hose mender  
D Schlauchreparatur  
RUS Соединитель шлангов

CZ Opravka  
RO Mufă înădire  
H Gyorstoldó  
E Reparador para manguera

1/2"  
12.5mm  
3/4"  
19mm  
ABS



No.	size / rozmiar	
89007	1/2" (12.5 mm)	30/240
89008	3/4" (19.0 mm)	30/240

PL Reparatör do węzła  
GB Hose mender  
D Schlauchreparaturstück  
RUS Соединитель шлангов

CZ Opravka  
RO Mufă înădire  
H Csatlakozó  
E Reparador para manguera

1/2"  
12.5mm  
3/4"  
19mm  
BRASS  
MOSIADZ



No.	size / rozmiar	
89074	1/2" (12.5 mm)	12/48
89075	3/4" (19.0 mm)	12/48

PL Reparatör do węzła  
GB Hose mender  
D Schlauchverbinder mit Reduktion  
RUS Соединитель шлангов

CZ Opravka  
RO Mufă înădire  
H Gyorstoldó  
E Reparador para manguera

1/2"  
12.5mm  
3/4"  
19mm  
ABS



No.	size / rozmiar	
89011	1/2"; 3/4" (12.5; 19.0 mm)	30/240

PL Nypel  
GB Male connector  
D Anschlussgerätestück  
RUS Адаптер внутренний

CZ Spojka  
RO Mufă pt. robinet cu filet exterior  
H Külső menetestölvég  
E Nypel

3/4"  
19mm  
ABS



No.	size / rozmiar	packing	
89239	3/4" (19.0 mm)		250/1000
89240	3/4" (19.0 mm)		24/288

PL Przyłącze do kranu  
GB Snap-in tap adaptor  
D Wasserhahnanschluss für Gartenschlauch  
RUS Адаптер внешний

CZ Šroubení  
RO Mufă pt. robinet cu filet interior  
H Tömlovég csaphoz  
E Tubuladura de grifo

3/4"  
19mm

ABS



No.	size / rozmiar	
89015	3/4" (19.0 mm)	30/240

PL Przyłącze do kranu  
GB Snap-in tap adaptor  
D Wasserhahnanschluss für Gartenschlauch  
RUS Адаптер внешний

CZ Šroubení  
RO Mufă pt. robinet cu filet interior  
H Tömlovég csaphoz  
E Tubuladura de grifo

3/4"  
19mm

BRASS  
MOSIADZ



No.	size / rozmiar	
89080	3/4" (19.0 mm)	12/48

PL Przyłącze do kranu  
GB Snap-in tap adaptor  
D Wasserhahnanschluss für Gartenschlauch  
RUS Адаптер внешний

CZ Šroubení  
RO Mufă pt. robinet cu filet interior  
H Tömlovég csaphoz  
E Tubuladura de grifo

3/4"  
19mm

ABS



No.	size / rozmiar	
89013	3/4" (19.0 mm)	30/240

PL Przyłącze do kranu  
GB Snap-in tap adaptor  
D Wasserhahnanschluss für Gartenschlauch  
RUS Адаптер для крана

CZ Šroubení  
RO Mufă pt. robinet cu filet interior  
H Tömlovég csaphoz  
E Tubuladura de grifo

3/4"  
19mm

1"  
25mm

BRASS  
MOSIADZ



No.	size / rozmiar	
89076	3/4" (19.0 mm)	12/48
89077	1" (25.0 mm)	12/48

PL Nypel  
GB Male connector  
D Anschlussgerätestück  
RUS Адаптер внутренний

CZ Spojka  
RO Mufă pt. robinet cu filet exterior  
H Kúlső menetesítővég  
E Nypel

3/4"  
19mm

BRASS  
MOSIADZ



No.	size / rozmiar	
89110	3/4" (19.0 mm)	48

PL Przyłącze do kranu  
GB Snap-in tap adaptor  
D Wasserhahnanschluss für Gartenschlauch  
RUS Адаптер для крана

CZ Šroubení  
RO Mufă pt. robinet cu filet interior  
H Tömlovég csaphoz  
E Tubuladura de grifo

3/4"  
19mm

ABS



No.	size / rozmiar	packing	
89235	3/4" (19.0 mm)		250/1000
89236	3/4" (19.0 mm)		24/288

PL Przyłącze do kranu  
GB Snap-in tap adaptor  
D Wasserhahnanschluss für Gartenschlauch  
RUS Адаптер для крана

CZ Šroubení  
RO Mufă pt. robinet cu filet interior  
H Tömlovég csaphoz  
E Tubuladura de grifo

3/4"  
19mm

1"  
25mm

BRASS  
MOSIADZ



No.	size / rozmiar	
89106	3/4" (19.0 mm)	48
89107	1" (25.0 mm)	48

PL Przyłącze do kranu  
GB Snap-in tap adaptor  
D Wasserhahnanschluss für Gartenschlauch  
RUS Адаптер для крана

CZ Šroubení  
RO Mufă pt. robinet cu filet interior  
H Tömlovég csaphoz  
E Tubuladura de grifo

1/2"  
12.5mm

3/4"  
19mm

1"  
25mm

ABS



No.	size / rozmiar	packing	
89241	1/2"; 3/4" (12.5; 19.0 mm)		250/1000
89242	1/2"; 3/4" (12.5; 19.0 mm)		24/288
89251	3/4"; 1" (19.0; 25.0 mm)		100/1000
89252	3/4"; 1" (19.0; 25.0 mm)		24/288

PL Przyłącze do kranu  
GB Snap-in tap adaptor  
D Wasserhahnanschluss für Gartenschlauch  
RUS Адаптер для крана

CZ Šroubení  
RO Mufă pt. robinet cu filet interior  
H Tömlovég csaphoz  
E Tubuladura de grifo



No.	size / rozmiar	
89017	1/2"; 3/4" (12.5; 19.0 mm)	30/240
89018	3/4"; 1" (19.0; 25.0 mm)	30/240

PL Przyłącze do kranu  
GB Snap-in tap adaptor  
D Wasserhahnanschluss für Gartenschlauch  
RUS Адаптер для крана

CZ Šroubení  
RO Mufă pt. robinet cu filet interior  
H Tömlovég csaphoz  
E Tubuladura de grifo



No.	size / rozmiar	
89078	1/2"; 3/4" (12.5; 19.0 mm)	12/48
89079	3/4"; 1" (19.0; 25.0 mm)	12/48

PL Złącze typu „I”  
GB 2 way coupling  
D Doppelkupplung  
RUS Переходник

CZ Spojka  
RO Prelungitor furtun apă  
H „I” típusú csötöldő idom  
E Junta tipo „I”



No.		
89020		30/240

PL Złącze typu „I”  
GB 2 way coupling  
D Doppelkupplung  
RUS Переходник

CZ Spojka  
RO Prelungitor furtun apă  
H „I” típusú csötöldő idom  
E Junta tipo „I”



No.		
89083		12/48

PL Przyłącze do kranu  
GB Snap-in tap adaptor  
D Wasserhahnanschluss für Gartenschlauch  
RUS Адаптер для крана

CZ Šroubení  
RO Mufă pt. robinet cu filet interior  
H Tömlovég csaphoz  
E Tubuladura de grifo

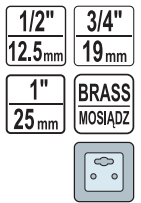

No.	size / rozmiar	
89108	1/2"; 3/4" (12.5; 19.0 mm)	48
89109	3/4"; 1" (19.0; 25.0 mm)	48

PL Złącze typu „I”  
GB 2 way coupling  
D Doppelkupplung  
RUS Соединитель шлангов

CZ Spojka  
RO Prelungitor furtun apă  
H „I” típusú csötöldő idom  
E Junta tipo „I”



No.	size / rozmiar	packing	
89245	1/2" (12.5 mm)	✗	125/500
89246	1/2" (12.5 mm)	☑	24/288

PL Złącze typu „I”  
GB 2 way coupling  
D Doppelkupplung  
RUS Переходник

CZ Spojka  
RO Prelungitor furtun apă  
H „I” típusú csötöldő idom  
E Junta tipo „I”



No.	size / rozmiar	
89113	1/2" (12.5 mm)	48

PL Rozdzielacz typu „Y”  
GB 3 way coupling  
D Drei wege kupplung  
RUS Тройник для шлангов

CZ Y-kus  
RO Distribuitor 3 căi  
H „Y” típusú elágazás  
E Distribuitor tipo „Y”



No.		packing	
89243		✗	125/250
89244		☑	24/288

PL Rozdzielacz typu „Y”  
GB 3 way coupling  
D Drei wege kupplung  
RUS Тройник для шлангов

CZ Y-kus  
RO Distributor 3 căi  
H „Y” típusú elágazás  
E Distribuidor tipo „Y”

1/2"  
12.5mm

BRASS  
MOSIADZ



FLO

No.	size / rozmiar	
89112	1/2" (12.5 mm)	48

PL Rozdzielacz z zaworami  
GB Y-switch coupling with swivel  
D 2-Wege Ventil  
RUS Распределитель внешний

CZ Rozbočovač s uzavíracími ventily  
RO Racord iny cu robinet  
H Y-elágazó, 2 db külső menetes elzáróval  
E Distribuidor tipo „Y”

1/2"  
12.5mm

3/4"  
19mm

ABS



FLO

No.	size / rozmiar	
89222	1/2"; 3/4" (12.5; 19.0 mm)	12/120

PL Czasowy wyłącznik przepływu wody  
GB Water timer  
D Bewässerungsuhr  
RUS Таймер для управления подачей воды

CZ Zavažovací hodiny  
RO Programator automat  
H Vizprogramozó óra  
E Programador manual para tubos de agua

3/4"  
19mm

1"  
25mm



FLO

No.	size / rozmiar	
89282	3/4"; 1" (19.0; 25.0 mm)	6/24

PL Zraszacz prosty regulowany  
GB Adjustable spray nozzle  
D Spritze  
RUS Распылитель поливочный

CZ Postřikovač  
RO Stropitor apă  
H Szórófej  
E Rociador

ABS



23 FLO

No.		
89200		25/150

PL Rozdzielacz z zaworami  
GB Y-switch coupling with swivel  
D 2-Wege Ventil  
RUS Распределитель внешний

CZ Rozbočovač s uzavíracími ventily  
RO Racord iny cu robinet  
H Y-elágazó, 2 db külső menetes elzáróval  
E Distribuidor tipo „Y”

3/4"  
19mm



FLO

No.	size / rozmiar	packing	
89247	3/4" (19.0 mm)		24/240
89248	3/4" (19.0 mm)		12/96

PL Czasowy wyłącznik przepływu wody  
GB Water timer  
D Bewässerungsuhr  
RUS Таймер для управления подачей воды

CZ Zavažovací hodiny  
RO Programator automat  
H Vizprogramozó óra  
E Programador manual para tubos de agua

3/4"  
19mm

1"  
25mm



FLO

No.	size / rozmiar	
89281	3/4"; 1" (19.0; 25.0 mm)	24

PL Zraszacz prosty regulowany  
GB Adjustable spray nozzle  
D Spritze  
RUS Распылитель поливочный

CZ Postřikovač  
RO Stropitor apă  
H Szórófej  
E Rociador

ABS



FLO

No.	packing	
89201		25/100
89202		12/48

PL Zraszacz prosty regulowany  
GB Adjustable spray nozzle  
D Spritze  
RUS Распылитель поливочный

CZ Postřikovač  
RO Stropitor apă  
H Szórófej  
E Rociador

ABS



FLO

No.		
89187		48



PL Zraszacz prosty  
GB Straight nozzle  
D Spritze  
RUS Распылитель поливочный

CZ Postřikovač  
RO Stropitor apă  
H Szórófej  
E Rociador simple



BRASS  
MOSIĄDZ



No.	size / rozmiar	
89120	1/2" (12.5 mm)	48

PL Pistolet zraszający regulowany  
GB Adjustable spray gun  
D Regelbare Sprühpistole  
RUS Регулируемый оросительный пистолет

CZ Kropící pistole regulovatelná  
RO Pistolet de irigare ajustabil  
H Öntöző pisztoly, állítható sugarú  
E Pistola rociadora ajustable

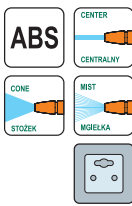

No.		
89210		12/48

PL Pistolet zraszający regulowany  
GB Adjustable spray gun  
D Regelbare Sprühpistole  
RUS Регулируемый оросительный пистолет

CZ Kropící pistole regulovatelná  
RO Pistolet de irigare ajustabil  
H Öntöző pisztoly, állítható sugarú  
E Pistola rociadora ajustable

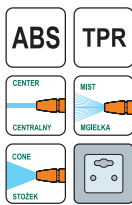

No.		
89214		12/48

PL Pistolet zraszający regulowany  
GB Adjustable spray gun  
D Regelbare Sprühpistole  
RUS Регулируемый оросительный пистолет

CZ Kropící pistole regulovatelná  
RO Pistolet de irigare ajustabil  
H Öntöző pisztoly, állítható sugarú  
E Pistola rociadora ajustable



No.		
89193		12/48

PL Zraszacz prosty regulowany  
GB Adjustable spray nozzle  
D Spritze  
RUS Распылитель поливочный

CZ Postřikovač  
RO Stropitor apă  
H Szórófej  
E Rociador

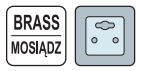

BRASS  
MOSIĄDZ



No.		
89090		12/48

PL Pistolet zraszający regulowany  
GB Adjustable spray gun  
D Regelbare Sprühpistole  
RUS Регулируемый оросительный пистолет

CZ Kropící pistole regulovatelná  
RO Pistolet de irigare ajustabil  
H Öntöző pisztoly, állítható sugarú  
E Pistola rociadora ajustable

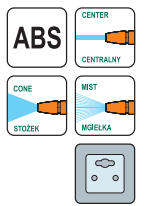

No.		
89213		12/48

PL Pistolet zraszający regulowany  
GB Adjustable spray gun  
D Regelbare Sprühpistole  
RUS Регулируемый оросительный пистолет

CZ Kropící pistole regulovatelná  
RO Pistolet de irigare ajustabil  
H Öntöző pisztoly, állítható sugarú  
E Pistola rociadora ajustable



No.		
89189		12/48

PL Pistolet zraszający regulowany  
GB Adjustable spray gun  
D Regelbare Sprühpistole  
RUS Регулируемый оросительный пистолет

CZ Kropící pistole regulovatelná  
RO Pistolet de irigare ajustabil  
H Öntöző pisztoly, állítható sugarú  
E Pistola rociadora ajustable

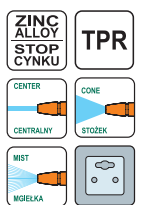

No.		
89194		6/24

PL Pistolet zraszający regulowany  
 GB Adjustable spray gun  
 D Regelbare Sprühpistole  
 RUS Регулируемый оросительный пистолет

CZ Kropící pistole regulovatelná  
 RO Pistolet de irigare ajustabil  
 H Öntöző pisztoly, állítható sugarú  
 E Pistola rociadora ajustable



FLO

No. 89190 12/48

PL Pistolet zraszający regulowany  
 GB Adjustable spray gun  
 D Regelbare Sprühpistole  
 RUS Регулируемый оросительный пистолет

CZ Kropící pistole regulovatelná  
 RO Pistolet de irigare ajustabil  
 H Öntöző pisztoly, állítható sugarú  
 E Pistola rociadora ajustable

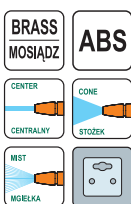

FLO

No. 89215 12/24

PL Wielofunkcyjny pistolet zraszający  
 GB Multifunction sprinkling gun  
 D Multifunktions-Spritzpistole  
 RUS Многофункциональный оросительный пистолет

CZ Multifunkční postřikovací pistole  
 RO Pistol multifuncțional pt. pulverizare  
 H Többfunkciós öntöző pisztoly  
 E Pistola para regar multifuncional

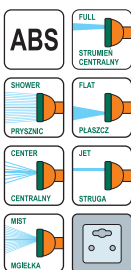

FLO

No. 89220 12/48

PL Wielofunkcyjny pistolet zraszający  
 GB Multifunction sprinkling gun  
 D Multifunktions-Spritzpistole  
 RUS Многофункциональный оросительный пистолет  
 CZ Multifunkční postřikovací pistole  
 RO Pistol multifuncțional pt. pulverizare  
 H Többfunkciós öntöző pisztoly  
 E Pistola para regar multifuncional



FLO

No. 89192 12/48

PL Pistolet zraszający regulowany  
 GB Adjustable spray gun  
 D Regelbare Sprühpistole  
 RUS Регулируемый оросительный пистолет

CZ Kropící pistole regulovatelná  
 RO Pistolet de irigare ajustabil  
 H Öntöző pisztoly, állítható sugarú  
 E Pistola rociadora ajustable

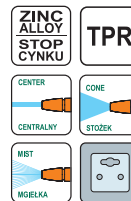

FLO

No. 89180 12/48

PL Pistolet zraszający  
 GB Sprinkling gun  
 D Spritzpistole  
 RUS Оросительный пистолет

CZ Postřikovací pistole  
 RO Pistol pt. pulverizare  
 H Öntöző pisztoly  
 E Pistola para regar



FLO

No. 89209 12/48

PL Wielofunkcyjny pistolet zraszający  
 GB Multifunction sprinkling gun  
 D Multifunktions-Spritzpistole  
 RUS Многофункциональный оросительный пистолет

CZ Multifunkční postřikovací pistole  
 RO Pistol multifuncțional pt. pulverizare  
 H Többfunkciós öntöző pisztoly  
 E Pistola para regar multifuncional

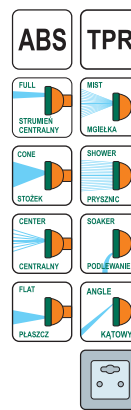

FLO

No. 89211 12/48

PL Wielofunkcyjny pistolet zraszający  
 GB Multifunction sprinkling gun  
 D Multifunktions-Spritzpistole  
 RUS Многофункциональный оросительный пистолет

CZ Multifunkční postřikovací pistole  
 RO Pistol multifuncțional pt. pulverizare  
 H Többfunkciós öntöző pisztoly  
 E Pistola para regar multifuncional

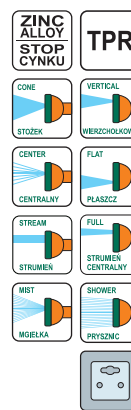

FLO

No. 89195 6/24

PL Wielofunkcyjny pistolet zraszający  
 GB Multifunction sprinkling gun  
 D Multifunktions-Spritzpistole  
 RUS Многофункциональный оросительный пистолет

CZ Multifunkční postřikovací pistole  
 RO Pistol multifuncțional pt. pulverizare  
 H Többfunkciós öntöző pisztoly  
 E Pistola para regar multifuncional



No.	
89191	12/48

PL Zestaw złączek ze zraszaczem prostym  
 GB Basic hose set with straight nozzle  
 D Bewässerungs Spritz und Anschlusset  
 RUS Набор поливочный

CZ Postřikovač + spojky  
 RO Ștut furtun apă cu accesorii pt. robinet  
 H Készlet gyorskapocsal csaphoz  
 E Juego de rociar tubuladura de grifo

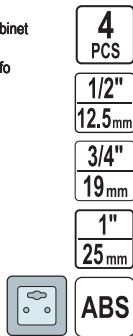

No.	size / rozmiar	pcs	
89203	3/4"; 1" (19.0; 25.0 mm)	4	12/72
89204	1/2"; 3/4" (12.5; 19.0 mm)	4	12/72

PL Zestaw złączek ze zraszaczem pistoletowym  
 GB Basic hose set with adjustable spray gun  
 D Spritzbrause und Anschlusset  
 RUS Набор поливочный

CZ Rozprašovací pistole na vodu + spojky  
 RO Pistol reglabil cu și accesorii  
 H Résztes készlet – os tömlőhöz  
 E Juego de rociar para manguera

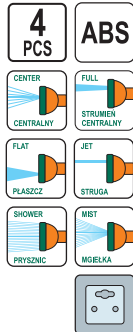

No.	size / rozmiar	pcs	
89206	1/2" (12.5 mm)	4	12/48

PL Zestaw złączek ze zraszaczem pistoletowym  
 GB Basic hose set with adjustable spray gun  
 D Spritzbrause und Anschlusset  
 RUS Набор поливочный

CZ Rozprašovací pistole na vodu + spojky  
 RO Pistol reglabil cu și accesorii  
 H Résztes készlet – os tömlőhöz  
 E Juego de rociar para manguera

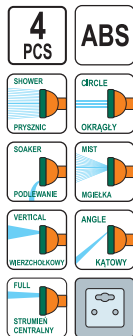

No.	size / rozmiar	pcs	
89208	1/2" (12.5 mm)	4	12/48

PL Wielofunkcyjny pistolet zraszający  
 GB Multifunction sprinkling gun  
 D Multifunktions-Spritzpistole  
 RUS Многофункциональный оросительный пистолет

CZ Multifunkční postřikovací pistole  
 RO Pistol multifuncțional pt. pulverizare  
 H Többfunkciós öntöző pisztoly  
 E Pistola para regar multifuncional

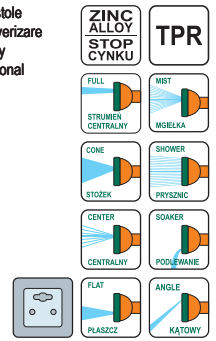

No.	
89181	12/48

PL Zestaw złączek ze zraszaczem prostym  
 GB Basic hose set with straight nozzle  
 D Bewässerungs Spritz und Anschlusset  
 RUS Набор поливочный

CZ Postřikovač + spojky  
 RO Ștut furtun apă cu accesorii pt. robinet  
 H Készlet gyorskapocsal csaphoz  
 E Juego de rociar tubuladura de grifo

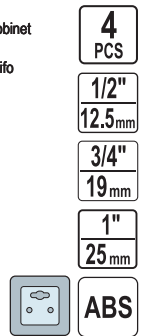

No.	size / rozmiar	
89256	1/2"; 3/4" (12.5; 19.0 mm)	12/48
89255	3/4"; 1" (19.0; 25.0 mm)	12/48

PL Zestaw złączek ze zraszaczem pistoletowym  
 GB Basic hose set with adjustable spray gun  
 D Spritzbrause und Anschlusset  
 RUS Набор поливочный

CZ Rozprašovací pistole na vodu + spojky  
 RO Pistol reglabil cu și accesorii  
 H Résztes készlet – os tömlőhöz  
 E Juego de rociar para manguera

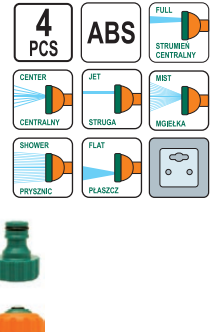

No.	size / rozmiar	pcs	
89207	1/2"; 3/4" (12.5; 19.0 mm)	4	12/48

PL Wąż spiralny z pistoletem zraszającym  
 GB Coil hose set with spray gun  
 D Spiralschlauch mit multifunktionsbrause  
 RUS Спиральный шланг в наборе с пистолетом

CZ Pištoľ striekacia s vinutou hadicou  
 RO Furtun în spirală cu pistol pt. stropit  
 H Locsoló pisztoly tömlővel  
 E Manguera espiral con rociador

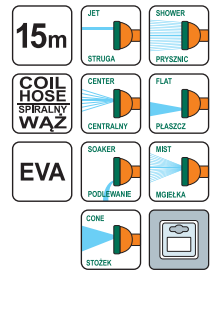

No.	L (m)	
89351	15	8

- PL Lanca zraszająca wielofunkcyjna  
 GB Sprinkling lance  
 D Multifunktions-Spritzstab  
 RUS Пика для распылителя многофункциональная  
 CZ Multifunkční postřikovací nadstavec  
 RO Tijă pt. irigare  
 H Többfunkciós esőztető fej  
 E Lanza para regar multifuncional

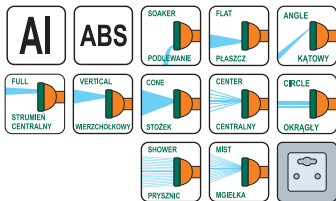

No.	12
89218	12

- PL Zestaw uszczelek  
 GB Set of gaskets  
 D Dichtungssatz  
 RUS Набор прокладок
- CZ Sada těsnění  
 RO Set de garnituri  
 H Tömítéskészlet esőztetőhöz  
 E Juego de juntas

14  
PCS



No.	pcs	for / dla	12/48
89270	14	89100-89267	20/80

- PL Zraszacz 3-ramienny  
 GB 3-arms revolving sprinkler  
 D 3-Arm Kreis-Regner  
 RUS Трехсторонний вращающийся распылитель на пике  
 CZ Rozprašovač třiramenný  
 RO Aspersol cu 3 brate  
 H Locsoló, leszűrhető, forgó  
 E Rociador 3-brazos



ABS



No.	12/48
89272	12/48

- PL Zraszacz 3-ramienny  
 GB 3-arm revolving sprinkler with spike  
 D 3-arm Kreis-Regner  
 RUS Трехсторонний вращающийся распылитель на пике  
 CZ Rozprašovač třiramenný  
 RO Aspersol cu 3 brate  
 H Locsoló, leszűrhető, forgó  
 E Rociador 3-brazos



ZINC ALLOY SPIKE  
 KOLEC ZE STOPU CYNKU



No.	12/48
89263	12/48

- PL Prysznic ogrodowy  
 GB Garden shower  
 D Gartendusche  
 RUS Распылитель садовый  
 CZ Zahradní sprcha  
 RO Duș pt. grădină  
 H Kerti zuhany  
 E Regadera para jardín

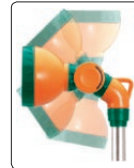
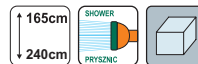

No.	6
89390	6

- PL Zraszacz 3-ramienny  
 GB 3-arms revolving sprinkler  
 D 3-Arm Kreis-Regner  
 RUS Трехсторонний вращающийся распылитель на пике  
 CZ Rozprašovač třiramenný  
 RO Aspersol cu 3 brate  
 H Locsoló, leszűrhető, forgó  
 E Rociador 3-brazos



ABS



No.	12/48
89262	12/48

- PL Zraszacz impulsowy  
 GB Impulse sprinkler  
 D Impulsregner  
 RUS Распылитель импульсный на пике  
 CZ Postřikovač  
 RO Stropitor apă  
 H Impulzus szórófej  
 E Rociador



ABS

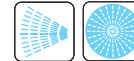

No.	12/48
89261	12/48

- PL Zraszacz impulsowy  
 GB Impulse sprinkler  
 D Impulsregner  
 RUS Распылитель импульсный на пике  
 CZ Postřikovač  
 RO Stropitor apă  
 H Impulzus szórófej  
 E Rociador

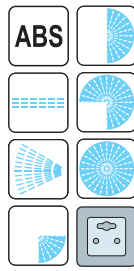

- PL Zraszacz impulsowy  
 GB Impulse sprinkler  
 D Impulsregner  
 RUS Распылитель импульсный на пике  
 CZ Postřikovač  
 RO Stropitor apă  
 H Impulzus szórófej  
 E Rociador

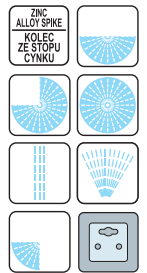

FLO

No.  
89269

12/48

FLO

No.  
89260

12/48

- PL Zraszacz 3-ramienny naziemny  
 GB 3-arms revolving sprinkler on base  
 D 3-Arm Kreis-Regner  
 RUS Трехсторонний вращающийся распылитель на подставке
- CZ Rozprašovac̣ tříramenný  
 RO Aspersol cu 3 brate  
 H Locsoló, leszúrható, forgó  
 E Rociador 3-brazos



- PL Zraszacz 8-funkcyjny  
 GB 8 pattern sprinkler  
 D 8-Flächenregner  
 RUS Распылитель 8-позиционный на подставке  
 CZ Postřikovač  
 RO Stropitor apă cu 8 duze  
 H 8 funkciós szórófej  
 E Rociador 8-funciones de tierra



FLO

No.  
89267

24

FLO

No.  
89265

24/48

- PL Zraszacz 8-funkcyjny  
 GB 8 pattern sprinkler  
 D 8-Flächenregner  
 RUS Распылитель 8-позиционный на подставке  
 CZ Postřikovač  
 RO Stropitor apă cu 8 duze  
 H 8 funkciós szórófej  
 E Rociador 8-funciones de tierra

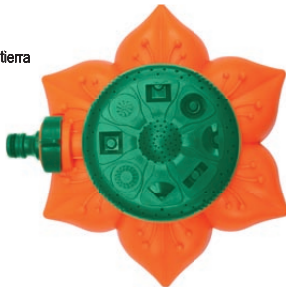

- PL Zraszacz impulsowy naziemny  
 GB Impulse sprinkler with base  
 D Impulsregner  
 RUS Распылитель импульсный  
 CZ Postřikovač  
 RO Stropitor apă  
 H Impulzus szórófej  
 E Rociador

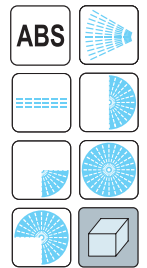

FLO

No.  
89273

6/36

FLO

No.  
89268

24

- PL Zraszacz impulsowy naziemny  
 GB Impulse sprinkler with base  
 D Impulsregner  
 RUS Распылитель импульсный  
 CZ Postřikovač  
 RO Stropitor apă  
 H Impulzus szórófej  
 E Rociador

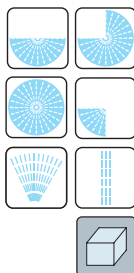

- PL Zraszacz "Szalona stokrotka"  
 GB Garden sprayer „Crazy Daisy”  
 D Garten sprinkler  
 RUS Распылитель  
 CZ Sprcha zahradní  
 RO Stropitor  
 H Kerti locsoló  
 E Rociador



FLO

No.  
89266

24

FLO

No.  
89351

12

- PL Zraszacz wyrzalny  
GB Impulse pop-up sprinkler  
D Tauchimpulsstrinkler  
RUS Дождеватель выдвигной
- CZ Zavlažovač výsuvný  
RO Aspersor cu impuls  
H Esőztető szórófej  
E Rociador de emerjer



No.	12
89280	12

- PL Wąż ogrodniczy  
GB Garden hose  
D Gartenschlauch  
RUS Садовый шланг
- CZ Zahradní hadice  
RO Furtun de gradina  
H Kerti tömlő  
E Manguera de jardín

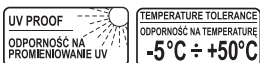

No.	L (m)	Ø	1
89311	20	1/2" (12.5 mm)	1
89312	30	1/2" (12.5 mm)	1
89313	50	1/2" (12.5 mm)	1
89314	20	3/4" (19.0 mm)	1
89315	30	3/4" (19.0 mm)	1
89316	50	3/4" (19.0 mm)	1
89318	20	1" (25.0 mm)	1
89319	30	1" (25.0 mm)	1
89320	50	1" (25.0 mm)	1

- PL Opaska ślimakowa do węża  
GB Hose clip  
D Schlauchklemme  
RUS Хомут стальной
- CZ Šneková páska  
RO Colier metalic  
H Csigapánt  
E Abrazadora



No.	Ø (mm)	for hose / do węża Ø	pcs.	10/20
73506	12-20	1/2" (12.5 mm)	4	20
73507	16-25	3/4" (19.0 mm)	4	10/20
73508	20-32	1" (25.0 mm)	4	20
73510	12-20	1/2" (12.5 mm)	4	20
	16-25	3/4" (19.0 mm)	4	20
73511	16-25	3/4" (19.0 mm)	4	20
	20-32	1" (25.0 mm)	4	20

- PL Wąż ogrodniczy  
GB Garden hose  
D Gartenschlauch  
RUS Садовый шланг
- CZ Zahradní hadice  
RO Furtun de gradina  
H Kerti tömlő  
E Manguera de jardín



No.	L (m)	Ø	1
89302	20	1/2" (12.5 mm)	1
89303	30	1/2" (12.5 mm)	1
89305	50	1/2" (12.5 mm)	1
89307	20	3/4" (19.0 mm)	1
89308	30	3/4" (19.0 mm)	1
89310	50	3/4" (19.0 mm)	1
89298	20	1" (25.0 mm)	1
89299	30	1" (25.0 mm)	1
89300	50	1" (25.0 mm)	1

- PL Wąż odpływowy do pomp  
GB Pump drain hose  
D Abflussschlauch für die Pumpen  
RUS Сливной шланг для насосов
- CZ Výtlačná hadice pro čerpadla  
RO Furtun de evacuare pt. pompe  
H Ebfolyó tömlő szivattyúhoz  
E Manguera de salida para bombas



No.	L (m)	Ø	wall thickness / grubość ścianki	15
79960	10	1" (25 mm)	1.2	15
79962	20	1" (25 mm)	1.2	8
79963	30	1" (25 mm)	1.2	6
79965	50	1" (25 mm)	1.2	3
79968	20	5/4" (32 mm)	1.4	6
79971	50	5/4" (32 mm)	1.4	3
79973	20	3/2" (38 mm)	1.8	4
79975	50	3/2" (38 mm)	1.8	2

- PL Stojak do węża ogrodowego  
GB Hose holder  
D Gartenschlauchträger  
RUS Барабан для намотки поливочного шланга
- CZ Stojan navíječ na zahradní hadici  
RO Suport pt. furtun  
H Utartódob locsolótömlőkhöz  
E Estante para manguera de jardín

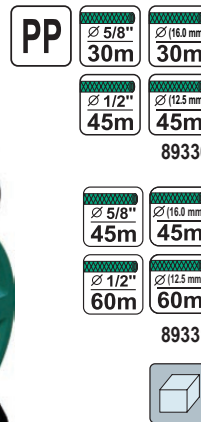

No.	size / rozmiar	5
89330	5/8" (16.0 mm) / 30m; 1/2" (12.5 mm) / 45m	5
89331	5/8" (16.0 mm) / 45m; 1/2" (12.5 mm) / 60m	5

- PL Wózek do węża ogrodowego  
 GB Hose cart  
 D Gartenschlauchwagen  
 RUS Барабан для намотки поливочного шланга  
 CZ Stojan navjeden na zahradní hadici  
 RO Suport pt. furtun  
 H Utartódob locsolótömlőhöz  
 E Carretilla para manguera de jardín



∅ 5/8" / 30m	∅ 16.0 mm / 30m
∅ 1/2" / 45m	∅ 12.5 mm / 45m
∅ 5/8" / 45m	∅ 16.0 mm / 45m
∅ 1/2" / 60m	∅ 12.5 mm / 60m

89335

89336



No.	size / rozmiar	
89335	5/8" (16.0 mm) / 30m; 1/2" (12.5 mm) / 45m	5
89336	5/8" (16.0 mm) / 45m; 1/2" (12.5 mm) / 60m	5

- PL Wieszak na wąż ogrodowy  
 GB Hose hanger  
 D Gartenschlauchträger  
 RUS Кронштейн настенный для шланга
- CZ Věšák na hadici zahradní  
 RO Suport de perete pt. furtun  
 H Kerítömlő-akasztó  
 E Colgador para manguera de jardín



No.	
89345	60

- PL Pompa ręczna  
 GB Hand pump  
 D Schwengelpumpe  
 RUS Насос ручной  
 CZ Pumpa ruční  
 RO Pompa manuala  
 H Kézi szivattyú  
 E Bomba de mano



No.	
89552	1

- PL Zestaw do podlewania  
 GB Watering set  
 D Bewässerung kit  
 RUS Набор для полива  
 CZ Zalévání kit  
 RO Kit de udare  
 H Locsoló készlet  
 E Set de riego con manguera

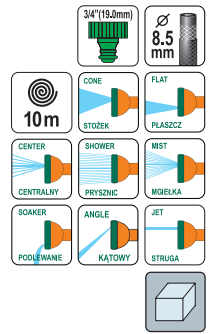

No.	L (m)	
89342	10	8

- PL Prowadnica węża  
 GB Hose guide  
 D Schlauchführung  
 RUS Направляющее приспособление для шланга
- CZ Vodítko s rolnami na hadici  
 RO Ghidaj pt. furtun  
 H Tömlő vezető  
 E Guidera para manguera



No.	
89348	6/24

- PL Podstawa pod pompę  
 GB Pump base  
 D Pumpenständer  
 RUS Подставка для насоса  
 CZ Podstavec pumpy  
 RO Suport pt. pompa  
 H Szivattyútalp  
 E Soporte para bomba





No.	for / dla	
89553	89552	1

- PL Pompa zatapialna do wody brudnej
- GB Dirty water submersible pump
- D Tauchmotorpumpe
- RUS Погружной насос
- CZ Zátavnací čerpadlo
- RO Pompă pt. apă murdară
- H Búvárszivattyú
- E Bomba de inmersión para agua sucia



230V~ 50Hz	1" 25mm
5/4" 32mm	1.5" 38mm





No.	W	l / h	H (max)	
79890	400	7500	5	4
79891	550	10500	7	4
79892	750	13000	9	2
79893	900	14000	10	2
79894	1100	15000	11	2

- PL Pompa zatapialna do wody brudnej
- GB Dirty water submersible pump
- D Tauchmotorpumpe
- RUS Погружной насос
- CZ Zátavnací čerpadlo
- RO Pompă pt. apă murdară
- H Búvárszivattyú
- E Bomba de inmersión para agua sucia

230V~ 50Hz	400 W	H max 6.0 m	6000 l/h
1" 25mm	5/4" 32mm	1.5" 38mm	



No.	W	l / h	
79909	400	6000	6

- PL Pompa zatapialna do wody brudnej
- GB Dirty water submersible pump
- D Tauchmotorpumpe
- RUS Погружной насос
- CZ Zátavnací čerpadlo
- RO Pompă pt. apă murdară
- H Búvárszivattyú
- E Bomba de inmersión para agua sucia

230V~ 50Hz	1" 25mm	5/4" 32mm	1.5" 38mm	
---------------	------------	--------------	--------------	---





No.	W	l / h	H (max)	
79904	550	10000	7	4
79905	750	12500	8	4
79906	900	14000	9	4
79907	1100	15000	10	4

- PL Pompa zatapialna do wody brudnej
- GB Dirty water submersible pump
- D Tauchmotorpumpe
- RUS Погружной насос
- CZ Zátavnací čerpadlo
- RO Pompă pt. apă murdară
- H Búvárszivattyú
- E Bomba de inmersión para agua sucia



230V~ 50Hz	1" 25mm
5/4" 32mm	1.5" 38mm





No.	W	l / h	H (max)	
79896	550	12500	8	2
79898	900	14500	10	2
79899	1100	15500	11	2

- PL Pompa zatapialna do wody brudnej
- GB Dirty water submersible pump
- D Tauchmotorpumpe
- RUS Погружной насос
- CZ Zátavnací čerpadlo
- RO Pompă pt. apă murdară
- H Búvárszivattyú
- E Bomba de inmersión para agua sucia

230V~ 50Hz	400 W	H max 5.0 m
5/4" 32mm	6500 l/h	



No.	W	l / h	
79903	400	6500	4

- PL Pompa membranowa zatapialna
- GB Membrane deep well water pump
- D Tauchmotorpumpe
- RUS Погружной насос
- CZ Zátavnací čerpadlo
- RO Pompă pt. apă cu membrana
- H Búvárszivattyú
- E Bomba de diafragma sumergible

230V~ 50Hz	280 W	H max 60 m
1/2" 12.5mm	1080 l/h	



No.	W	l / h	
79942	280	1080	4



- PL Pompa zatapiałna do wody brudnej i ścieków  
 GB Submersible pump for dirty water and wastewater  
 D Tauchpumpe für Schmutzwasser  
 RUS Погружной насос для грязной воды  
 CZ Ponorné čerpadlo pro odpadní vody  
 RO Pompă submersibilă pt. apă uzată  
 H Búvárszivattyú szennyvíz  
 E Bomba sumergible para aguas residuales



No.	W	l / h	H (max)	
79880	450	16000	9	1

- PL Pompa ogrodowa  
 GB Jet pump  
 D Gartenpumpe  
 RUS Насос садовый

- CZ Zahradní čerpadlo  
 RO Pompa apa  
 H Kerti szivattyúhoz  
 E Bomba de jardín con cabeza

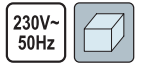

$L_{pA} = 67,5 \pm 3,0$  dB;  $L_{wA} = 78,5 \pm 3,0$  dB

No.	W	l / h	H (max)	max. pressure / max. ciśnienie (bar)	
79912	600	2800	35	3.5	1
79913	800	3200	40	4.0	1
79914	1000	3500	44	4.4	1

- PL Pompa fontanna  
 GB Fountain pump  
 D Springbrunnenpumpe  
 RUS Фонтанный насос  
 CZ Fontánová pumpa  
 RO Pompa pt. fantana arteziana  
 H Pumpa szökőkúthoz  
 E Bomba para las fuentes



No.	W	l / h	H (max)	
79926	8	600	1.0	12
79927	16	800	1.3	12
79928	22	1000	1.6	12

- PL Pompa fontanna  
 GB Fountain pump  
 D Springbrunnenpumpe  
 RUS Фонтанный насос  
 CZ Fontánová pumpa  
 RO Pompa pt. fantana arteziana  
 H Pumpa szökőkúthoz  
 E Bomba para las fuentes



No.	W	l / h	H (max)	
79929	28	1400	2.0	8
79930	40	1800	2.5	8

- PL Pompa fontanna  
 GB Fountain pump  
 D Springbrunnenpumpe  
 RUS Фонтанный насос  
 CZ Fontánová pumpa  
 RO Pompa pt. fantana arteziana  
 H Pumpa szökőkúthoz  
 E Bomba para las fuentes



No.	W	l / h	H (max)	
79931	55	2000	2.5	8
79932	85	3000	3.5	8
79933	100	4500	4.5	6

- PL Sekator uniwersalny  
 GB By-pass pruner  
 D Rebenschere  
 RUS Секатор

- CZ Nožnice zahradnícke  
 RO Foarfecă pt. pomi  
 H Metszőolló  
 E Podadera universal



No.	L (mm)	
99193	180	12/120

- PL Sekator uniwersalny  
 GB By-pass pruner  
 D Rebenschere  
 RUS Секатор

- CZ Nožnice zahradnícke  
 RO Foarfecă pt. pomi  
 H Metszőolló  
 E Podadera universal



No.	L (mm)	
99194	190	12/120

PL Sekator uniwersalny CZ Nożnice zahradnicke  
 GB By-pass pruner RO Foarfece pt. pomi  
 D Rebenschere H Metszoolló  
 RUS Cекатор E Podadera universal



No.	L (mm)	
99230	200	20/60

PL Sekator uniwersalny CZ Nożnice zahradnicke  
 GB By-pass pruner RO Foarfece pt. pomi  
 D Rebenschere H Metszoolló  
 RUS Cекатор E Podadera universal



No.	L (mm)	
99209	215	6/48

PL Sekator uniwersalny CZ Nożnice zahradnicke  
 GB By-pass pruner RO Foarfece pt. pomi  
 D Rebenschere H Metszoolló  
 RUS Cекатор E Podadera universal



No.	L (mm)	
99203	205	20/60

PL Sekator uniwersalny CZ Nożnice zahradnicke  
 GB By-pass pruner RO Foarfece pt. pomi  
 D Rebenschere H Metszoolló  
 RUS Cекатор E Podadera universal



No.	L (mm)	
99208	200	12/60

PL Sekator uniwersalny CZ Nożnice zahradnicke  
 GB By-pass pruner RO Foarfece pt. pomi  
 D Rebenschere H Metszoolló  
 RUS Cекатор E Podadera universal

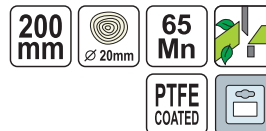

No.	L (mm)	
99190	200	18/72

PL Sekator uniwersalny CZ Nożnice zahradnicke  
 GB By-pass pruner RO Foarfece pt. pomi  
 D Rebenschere H Metszoolló  
 RUS Cекатор E Podadera universal

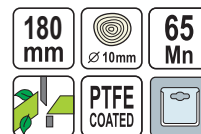

No.	L (mm)	
99202	180	18/72

PL Sekator uniwersalny CZ Nożnice zahradnicke  
 GB By-pass pruner RO Foarfece pt. pomi  
 D Rebenschere H Metszoolló  
 RUS Cекатор E Podadera universal

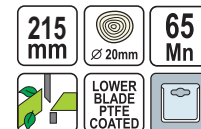

No.	L (mm)	
99204	215	20/60

PL Sekator kowadelkowy CZ Nożnice zahradnicke  
 GB Professional anvil pruner RO Foarfece pt. pomi  
 D Amboss-Gartenschere H Metszoolló  
 RUS Cекатор E Podadera de bigornia

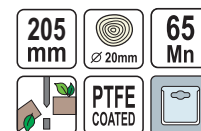

No.	L (mm)	
99207	205	20/60

PL Sekator kowadełkowy  
 GB Professional anvil pruner  
 D Amboss-Gartenschere  
 RUS Секатор

CZ Nožnice zahradnícke  
 RO Foarfece pt. pomi  
 H Metszoolló  
 E Podadera de bigornia

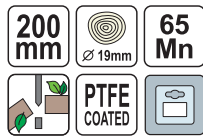

No.	L (mm)	
99191	200	18/72

PL Sekator do obcinania zawiązków  
 GB Fruit and flowers shears  
 D Blumen- und Rebschere  
 RUS Цветочные ножницы

CZ Nožnice zahradnícke  
 RO Foarfece pt. pomi  
 H Metszoolló  
 E Podadera para cortar germenes



No.	L (mm)	
99240	190	12/72

PL Nożyce florystyczne  
 GB Flower shears  
 D Blumenschere  
 RUS Цветочные ножницы

CZ Květinové nůžky  
 RO Foarfece de grădină  
 H Virág ollók  
 E Tijeras de podar



No.	L (mm)	
99181	145	12/120

PL Sekator do gałęzi  
 GB By-pass lopping shears  
 D Astschere  
 RUS Сучкорез

CZ Nožnice zahradnícke  
 RO Foarfece curbata pt. taiat crengi  
 H Ágvágó fix  
 E Podadera para ramas

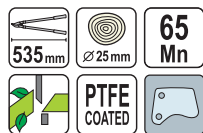

No.	L (mm)	
99103	535	12

PL Sekator wielofunkcyjny  
 GB Garden pocket pruner  
 D Rebenschere  
 RUS Секатор

CZ Nožnice zahradnícke  
 RO Foarfece pt. pomi  
 H Metszoolló  
 E Tijeras de podar



No.	L (mm)	
99210	200	12/48

PL Nożyce florystyczne  
 GB Flower shears  
 D Blumenschere  
 RUS Цветочные ножницы

CZ Květinové nůžky  
 RO Foarfece de grădină  
 H Virág ollók  
 E Tijeras de podar



No.	L (mm)	
99180	170	12/120

PL Nożyce florystyczne  
 GB Flower shears  
 D Blumenschere  
 RUS Цветочные ножницы

CZ Květinové nůžky  
 RO Foarfece de grădină  
 H Virág ollók  
 E Tijeras de podar



No.	L (mm)	
99182	165	12/120

PL Sekator do gałęzi  
 GB By-pass lopping shears  
 D Astschere  
 RUS Сучкорез

CZ Nožnice zahradnícke  
 RO Foarfece curbata pt. taiat crengi  
 H Ágvágó fix  
 E Podadera para ramas

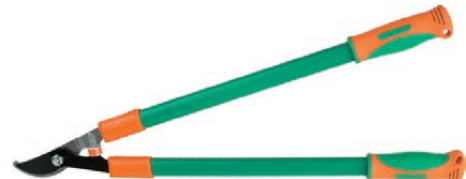
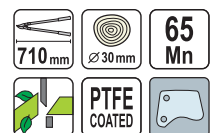

No.	L (mm)	
99109	710	10

PL Sekator do gałęzi  
 GB By-pass lopping shears  
 D Astschere  
 RUS Сучкорез  
 CZ Nožnice zahradnicke  
 RO Foarfeca curbata pt. taiat crengi  
 H Ágvágó fix  
 E Podadera para ramas



No.	L (mm)	☐
99116	740	12

PL Sekator do gałęzi  
 GB Anvil lopping shears  
 D Astschere  
 RUS Сучкорез с храповым механизмом  
 CZ Nožnice zahradnicke na hrubé konáre  
 RO Foarfeca curbata pt. taiat crengi  
 H Ágvágó fix  
 E Podadera para ramas con carraca

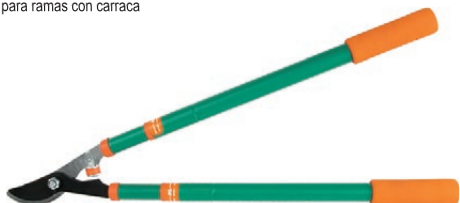
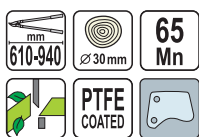

No.	L (mm)	☐
99115	610-940	12

PL Sekator do gałęzi  
 GB Anvil lopping shears  
 D Astschere  
 RUS Сучкорез с храповым механизмом  
 CZ Nožnice zahradnicke na hrubé konáre  
 RO Foarfeca curbata pt. taiat crengi  
 H Ágvágó fix  
 E Podadera para ramas con carraca



No.	L (mm)	☐
99112	735	12

PL Przedłużka teleskopowa  
 GB Telescopic handle  
 D Teleskopstange  
 RUS Ручьятка телескопическая

CZ Teleskopický prodlužovač  
 RO Prelungitor telescopic  
 H Teleszkópos hosszabbító  
 E Tubo de prolongación telescópico

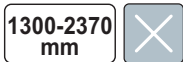

No.	L (mm)	☐
99315	1300-2370	12

PL Sekator do gałęzi  
 GB By-pass lopping shears  
 D Astschere  
 RUS Сучкорез  
 CZ Nožnice zahradnicke  
 RO Foarfeca curbata pt. taiat crengi  
 H Ágvágó fix  
 E Podadera para ramas

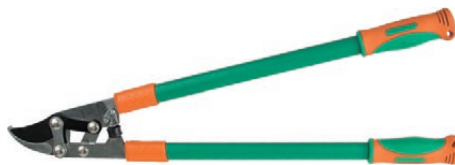

No.	L (mm)	☐
99111	750	12

PL Sekator do gałęzi  
 GB Anvil lopping shears  
 D Astschere  
 RUS Сучкорез с храповым механизмом  
 CZ Nožnice zahradnicke na hrubé konáre  
 RO Foarfeca curbata pt. taiat crengi  
 H Ágvágó fix  
 E Podadera para ramas con carraca

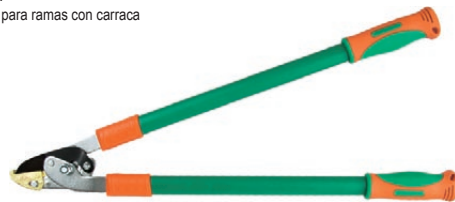

No.	L (mm)	☐
99110	710	12

PL Sekator gašenicowy z piłą  
 GB Leverage tree pruner  
 D Baumsäge mit astschere  
 RUS Сучкорез штанговый с пилой

CZ Střiháč na větve s pilovým listem  
 RO Fierastrău pt. pomi cu prelungitor  
 H Kőteles ágvágó  
 E Podadera de palanca con sierra

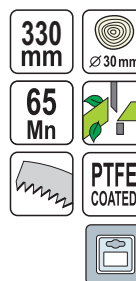

No.	L (mm)	☐
99310	330	12/24

PL Nożyce do żywoplotu  
 GB Hedge shears  
 D Heckenschere  
 RUS Кусторезы  
 CZ Nožnice na živý plot  
 RO Foarfeca pt. gard viu  
 H Sővényvágó olló  
 E Tijeras para seto vivo



No.	L (mm)	☐
99005	535	24

- PL Nożyce do żywoplotu  
 GB Hedge shears  
 D Heckenschere  
 RUS Кусторезы  
 CZ Nožnice na živý plot  
 RO Foarfeca pt. gard viu  
 H Sövényvágó olló  
 E Tijeras para seto vivo



No.	L (mm)	box
99006	630	12

- PL Nożyce do trawy wielopozycyjne  
 GB Grass shears  
 D Handgrasschere  
 RUS Ножницы для стрижки травы

- CZ Nůžky na trávu  
 RO Foarfeca pt. gazon  
 H Forgatható fűnyíró olló  
 E Tijeras de césped

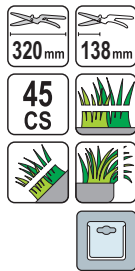

No.	L (mm)	box
99300	320	12/48

- PL Pila ogrodnicza - lisi ogon  
 GB Pruning saw  
 D Baumsäge  
 RUS Пила садовая

- CZ Zahradnická pila - liščí ocas  
 RO Fierăstrău pt. grădină-coadă de vulpe  
 H Gallyazófűrész-rókafarjú  
 E Sierra de jardín - cola de zorro

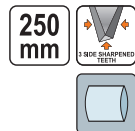

No.	L (mm)	box
28640	250	12/120

- PL Pila do gałęzi z kaburą  
 GB Bow saw  
 D Bügelsäge  
 RUS Лучковая пила

- CZ Oblouková pila  
 RO Ferăstrău de curbură  
 H Keretes fűrész  
 E Sierra de arco

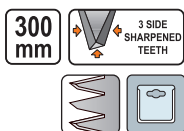

No.	L (mm)	box
28642	300	12/36

- PL Nożyce do żywoplotu  
 GB Hedge shears  
 D Heckenschere  
 RUS Кусторезы  
 CZ Nožnice na živý plot  
 RO Foarfeca pt. gard viu  
 H Sövényvágó olló  
 E Tijeras para seto vivo



No.	L (mm)	blade / ostrze L (mm)	box
99007	590	185	18
99008	620	215	18

- PL Nożyce do trawy wielopozycyjne  
 GB Grass shears  
 D Handgrasschere  
 RUS Ножницы для стрижки травы

- CZ Nůžky na trávu  
 RO Foarfeca pt. gazon  
 H Forgatható fűnyíró olló  
 E Tijeras de césped

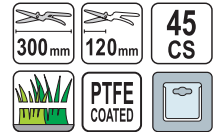

No.	L (mm)	box
99301	300	12/48

- PL Pila do gałęzi składana  
 GB Pruning saw  
 D Baumsäge  
 RUS Пила садовая

- CZ Zahradnická pila  
 RO Fierăstrău pt. perforare  
 H Gallyazófűrész  
 E Sierra para ramos plegable

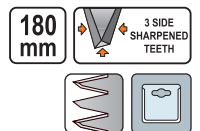

No.	L (mm)	box
28641	180	20/60

- PL Pila kablakowa  
 GB Bow saw  
 D Bügelsäge  
 RUS Лучковая пила

- CZ Oblouková pila  
 RO Ferăstrău de curbură  
 H Keretes fűrész  
 E Sierra de arco

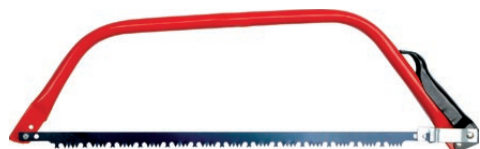

No.	L (mm)	box
28740	515	24
28750	735	24

PL Pila kabląkowa  
GB Bow saw  
D Bűgelsäge  
RUS Лучковая пила

CZ Oblouková pila  
RO Ferăstrău de curbură  
H Keretes fűrés  
E Sierra de arco



FLO

No.	L (mm)	
28745	530	12/24

PL Brzeszczot  
GB Spare blade for bow saw  
D Bűgelsägeblatt  
RUS Полотно д/пилы „Лидер”

CZ Ostří na dřevo  
RO Panza fierăstrău tip arc  
H Fűrészlap fához  
E Hoja de sierra

WET WOOD

DREWNO MOKRE



FLO

No.	L (mm)	W (mm)	
28771	530	20	60/240
28772	610	20	60/240
28773	760	20	60/240

PL Siekiera  
GB Axe  
D Handbeil  
RUS Топор

CZ Sekyřka  
RO Toporișca  
H Szekerce  
E Hacha



FLO

No.	g	
33067	600	24
33087	800	20
33107	1000	12
33127	1250	12
33147	1400	12
33177	1600	12

PL Pila kabląkowa  
GB Bow saw  
D Bűgelsäge  
RUS Лучковая пила

CZ Oblouková pila  
RO Ferăstrău de curbură  
H Keretes fűrés  
E Sierra de arco



FLO

No.	L (mm)	
28746	610	12/24
28755	760	12/24

PL Siekiera ze stali kutej  
GB Drop forged hatchet  
D Handbeil  
RUS Топор стальной кованный

CZ Sekera ocelová kovaná  
RO Toporișca lama forjată  
H Kovácsolt acél fejű szeke  
E Hacha de metal forjado



FLO

No.	kg	
33080	0.8	12/24

PL Siekiera  
GB Axe  
D Handbeil  
RUS Топор

CZ Sekyřka  
RO Toporișca  
H Szekerce  
E Hacha



FLO

No.	kg	
32930	1.0	10

PL Siekiera, rączka z włókna szklanego  
GB Axe with fibreglass + PVC handle  
D Handbeil fiberglasstiel  
RUS Топор с фиберглассовой ручкой

CZ Sekyřka  
RO Toporișca cu coada din fibra de sticlă  
H Szekerce  
E Hacha con mango de fibra de vidrio



VOREL

No.	g	
33065	600	20
33085	800	20
33105	1000	12
33125	1250	6

PL Siekiera  
 GB Axe  
 D Handbeil  
 RUS Топор

CZ Sekyrka  
 RO Toporișca  
 H Szekerce  
 E Hacha

DIN  
 5131  
 7294



**JUCO**

No.	kg	
33024	0.4	5
33026	0.6	5
33028	0.8	5
33030	1.0	5
33032	1.25	5
33035	1.50	5
33038	1.80	5
33039	2.0	5
33040	2.50	5

PL Siekiera z klinem  
 GB Axe  
 D Handbeil  
 RUS Топор

CZ Sekyrka  
 RO Toporișca  
 H Szekerce  
 E Hacha



**JUCO**

No.	kg	
32924	2	5

PL Siekiero-młot  
 GB Hammer-axe for wood splitting  
 D Spaltaxt  
 RUS Топор-колун

CZ Sekera-kladivo  
 RO Secure-ciocan  
 H Szekerce-kalapács  
 E Hacha martillo para partir madera



**JUCO**

No.	kg	
32927	2.1	1
32928	3.2	1

PL Siekiera  
 GB Axe  
 D Handbeil  
 RUS Топор

CZ Sekyrka  
 RO Toporișca  
 H Szekerce  
 E Hacha

DIN  
 5131  
 7294



**JUCO**

No.	kg	
33000	0.4	5
33001	0.6	5
33002	0.8	5
33003	1.0	5
33004	1.25	5
33005	1.50	5
33006	1.80	5
33007	2.0	5
33008	2.50	5

PL Siekiero-młot  
 GB Hammer-axe for wood splitting  
 D Spaltaxt  
 RUS Топор-колун

CZ Sekera-kladivo  
 RO Secure-ciocan  
 H Szekerce-kalapács  
 E Hacha martillo para partir madera



**JUCO**

No.	kg	
32925	2.5	1
32926	4.0	1

PL Siekiera kanadyjska  
 GB Canadian axe  
 D Handbeil „Kanadische Form“  
 RUS Топор тип канадский

CZ Sekera kanadská  
 RO Topor canadian  
 H Hosszú nyelű, hasító fejsze  
 E Hacha canada

1.8  
 kg



**JUCO**

No.	kg	
33022	1.8	5

- PL Klin do rozłupywania drewna  
 GB Wood splitter  
 D Spaltkeil  
 RUS Кли́н для раскалывания бревен
- CZ Klin na štípání polen  
 RO Pana pt. lemn  
 H Fahasító ék  
 E Cuiña para partir madera



**JUCO**

No.	kg	
32922	2	1
32923	3	1

- PL Lopatka  
 GB Trowel  
 D Blumenkelle  
 RUS Совок посадочный  
 CZ Lopatka  
 RO Mini-lopata gradinarit  
 H Ásó  
 E Paleta ancha



**FLO**

No.	L (mm)	
99047	350	25/100

- PL Motyczka z pazurkami  
 GB Hoe + cultivator  
 D Kleinhacke  
 RUS Рыхлитель комбинированный
- CZ Motyčka s hrabičkami  
 RO Sapaľiga + cultivator  
 H Kerti villás kapa  
 E Azadilla con escarificador



**FLO**

No.	L (mm)	
99050	300	50

- PL Pazurki  
 GB Cultivator  
 D Grubber  
 RUS Рыхлитель садовый
- CZ Kultivátor  
 RO Cultivator  
 H Kultivátor  
 E Escarificador



**FLO**

No.	L (mm)	
99049	310	25/100

- PL Łopatka  
 GB Trowel  
 D Blumenkelle  
 RUS Совок посадочный  
 CZ Lopatka  
 RO Mini-lopata gradinarit  
 H Ásó  
 E Paleta ancha



**FLO**

No.	L (mm)	
99048	350	25/100

- PL Grabki  
 GB Rake  
 D Kleinrechen  
 RUS Грабли
- CZ Hrabičky  
 RO Mini grebla  
 H Gereblye  
 E Rasirilo



**FLO**

No.	L (mm)	
99051	300	25/100

- PL Motyczka  
 GB Hoe  
 D Garten handhacke  
 RUS Мотыжка
- CZ Motyčka  
 RO Săpăligă  
 H Kerti kapa  
 E Azadilla



**FLO**

No.	L (mm)	
99052	300	25/100

- PL Łopatka  
 GB Trowel  
 D Blumenkelle  
 RUS Совок посадочный  
 CZ Lopatka  
 RO Mini-lopata gradinarit  
 H Ásó  
 E Paleta ancha



**FLO**

No.	L (mm)	
99020	435	12/72



PL Łopatka do korzeni  
GB Weeding trowel  
D Wurzelstecher  
RUS Лопатка для  
корней растений

CZ Lopatka na kořeny rostlin  
RO Lopata pt. buruienii  
H Kerti űletelő  
E Paleta

490 mm



No.	L (mm)	
99027	490	12/72

PL Grabki wachlarzowe  
GB Garden rake  
D Landschaftsbesen  
RUS Грабли веерные

CZ Hraňičky  
RO Grebla de gradina  
H Kerti gereblye  
E Rastrillo de abanico de hojalata

505 mm



No.	L (mm)	
99025	505	12/72

PL Pazurki oprawione  
GB Cultivator  
D Grubber  
RUS Рыхлитель садовый

CZ Kultivátor  
RO Cultivator  
H Kultivátor  
E Escarificador

425 mm



No.	L (mm)	
99023	425	12/72

PL Łopatka  
GB Trowel  
D Blumenkelle  
RUS Совок посадочный  
CZ Lopatka  
RO Mini-lopată gradinarit  
H Ásó  
E Paleta ancha

305 mm



No.	L (mm)	
99012	305	12/72

PL Grabki  
GB Rake  
D Kleinrechen  
RUS Грабли

CZ Hraňičky  
RO Mini grebla  
H Gereblye  
E Rastrillo

365 mm



No.	L (mm)	
99024	365	12/72

PL Motyczka z pazurkami  
GB Hoe + cultivator  
D Kleinhacke  
RUS Рыхлитель комбинированный

CZ Motyčka s hraňičkami  
RO Sapaliga + cultivator  
H Kerti villás kapa  
E Azadilla con escarificador

370 mm



No.	L (mm)	
99021	370	12/72

PL Obcinacz obrzeży trawnika  
GB Patio weeder  
D Rasenkantenstecher  
RUS Садовый нож для обработки краев газона  
CZ Nůžky na okraje trávníků  
RO Cutit pt. taiat gazonul  
H Pázsitszegély vágó  
E Cortador de reborde de cespèd

445 mm



No.	L (mm)	
99026	445	12/72

PL Łopatka  
GB Trowel  
D Blumenkelle  
RUS Совок посадочный  
CZ Lopatka  
RO Mini-lopată gradinarit  
H Ásó  
E Paleta ancha

305 mm



No.	L (mm)	
99011	305	12/72

PL Pazurki  
GB Cultivator  
D Grubber  
RUS Рыхлитель садовый

CZ Kultivátor  
RO Cultivator  
H Kultivátor  
E Escarificador

255 mm



No.	L (mm)	
99013	255	12/72

PL Motyczka  
GB Hoe  
D Garten handhacke  
RUS Мотыжка

CZ Motyčka  
RO Săpăligă  
H Kerti kapá  
E Azadilla

350 mm



No.	L (mm)	
35768	350	50

PL Sadzarka do cebuli  
GB Bulb planter  
D Blumenweibelplanzer  
RUS Конус посадочный для рассады  
CZ Sázeč  
RO Plantator  
H Palántázó  
E Plantadora para cebollas



No.		
99033		10/60

PL Saperka wielofunkcyjna  
GB Multifunctional shovel  
D Kombi-faltschaufel  
RUS Складная лопата многофункциональная  
CZ Lopatka víceúčelová  
RO Lopata multifunctionala  
H Többfunkciós ásó  
E Zapadora multifuncion

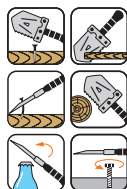

No.		
99053		36

PL Łopatka  
GB Trowel  
D Blumenkelle  
RUS Совок посадочный  
CZ Lopatka  
RO Mini-lopată gradinarit  
H Ásó  
E Paleta ancha

320 mm



No.	L (mm)	
35765	320	50

PL Pazurki  
GB Cultivator  
D Grubber  
RUS Рыхлитель садовый

CZ Kultivátor  
RO Cultivator  
H Kultivátor  
E Escarificador

330 mm



No.	L (mm)	
35767	330	50

PL Zbierak do owoców  
GB Fruit pick up tool  
D Obstpfücker  
RUS Съёмник для фруктов

CZ Sběrač ovoce  
RO Culegator pt. fructe  
H Karos gyümölcszedő  
E Recolector de frutas



No.	Ø (mm)	
89880	160	12/48

PL Saperka składana  
GB Folding shovel  
D Faltschaufel  
RUS Складная лопата складная

CZ Lopatka skládaci  
RO Lopata demontabila  
H Összecsukható ásó  
E Zapadora desmontable



No.		
99054		36

PL Komplet narzędzi ogrodowych  
GB Garden tool set  
D Garten-Kleingerätesatz  
RUS Набор садово-огородного инструмента

CZ Sada zahradnického náčiní  
RO Set pt. grădinărit  
H Kertész készlet  
E Juego de herramientas de jardín

3  
PCS



No.	L (mm)	☐
99028	205	50

PL Szpadel  
GB Spade  
D Rodespaten  
RUS Заступ

CZ Lisovaný ryč kalená  
RO Hârlet cu coadă  
H Ásó, sajított-edzett  
E Pala



No.	type	☐
35809	DY	250

PL Łopata piaskowa  
GB Shovel  
D Schaufel  
RUS Лопата совковая песочная

CZ Osazený ryč pískový  
RO Lopată pt. nisip  
H Homoklapát  
E Pala arena



No.	type	☐
35843	DY	120

PL Łopata węglowa  
GB Shovel  
D Kohlschaufel  
RUS Лопата угольная

CZ Úhlový ryč číslu  
RO Lopată pt. cărbune  
H Szeneslapát  
E Pala carbón



No.	type	☐
35863	DY	120

PL Komplet narzędzi ogrodowych  
GB Garden tool set  
D Garten-Kleingeräte-set  
RUS Набор садово-огородного инструмента

CZ Sada zahradnického náčiní  
RO Set pt. grădinărit  
H Kertész készlet  
E Juego de herramientas de jardín

3  
PCS



No.	pcs	☐
99055	3	12/48

PL Szpadel  
GB Spade  
D Rodespaten  
RUS Заступ

CZ Lisovaný ryč kalená  
RO Hârlet cu coadă  
H Ásó, sajított-edzett  
E Pala



No.	type	☐
35810	DY	250

PL Łopata piaskowo - żwirowa  
GB Shovel  
D Schaufel  
RUS Лопата совковая песочная

CZ Osazený ryč pískový  
RO Lopată pt. nisip  
H Homoklapát  
E Pala arena



No.	type	☐
35861	DY	120

PL Widły  
GB Digging fork  
D Grabegabel  
RUS Вилы свекловичные кованые

CZ Zahradnické vidlice  
RO Furcă pt. grădinărit  
H Vasvilla  
E Horca



No.	type	☐
35817	DY	250

PL Grabie  
GB Rake  
D Rechen  
RUS Грабли

CZ Hrábě  
RO Greblă  
H Gereblye  
E Rastrillo

130 cm P



FLO

No.	teeth / zęby	type	<input type="checkbox"/>
35756	10	P	250
35757	12	P	250
35758	14	P	250
35759	16	P	250

PL Grabie wachlarzowe  
GB Spring rake  
D Landschaftsbesen  
RUS Грабли веерные

CZ Hrábičky  
RO Grebla de gradina  
H Kerti gereblye  
E Rastrillo de abanico de hojalata

120 cm



FLO

No.	working part width / szer. części roboczej (cm)	teeth / zęby	<input type="checkbox"/>
35799	40	21	250

PL Nóż do darni  
GB Long handle steel edger  
D Rasenkantenstecher  
RUS Полулунный нож для обрезки краев дерна

CZ Nuz na okraje travniku  
RO Tăietor de borduri  
H Gyepgondozás  
E Cortador de bordes para césped

T



FLO

No.	working part width / szer. części roboczej (mm)	type	<input type="checkbox"/>
35680	200	T	200

PL Szpadel  
GB Spade  
D Rodespaten  
RUS Заступ

CZ Lisovaný rýč kalená  
RO Hârleț cu coadă  
H Ásó, sajított-edzett  
E Pala

T



FLO

No.	type	<input type="checkbox"/>
35802	T	140

PL Motyka  
GB Garden hoe  
D Garten handhacke  
RUS Тяпка

CZ Motyčka  
RO Săpăliga  
H Kerti kapa  
E Azadilla

120 cm P



FLO

No.	working part width / szer. części roboczej (cm)	type	<input type="checkbox"/>
35761	12	P	250
35762	14	P	250

PL Świder ręczny do gleby  
GB Gimlet to the soil  
D Handbohrer für den Erdboden  
RUS Ручной почвенный бур

CZ Ruční vrták do půdy  
RO Sfredel manual pt. pământ  
H Kézi talajfúró  
E Taladro manual para suelo



FLO

No.	Ø (mm)	<input type="checkbox"/>
35670	170	50
35671	250	24

PL Szpadel  
GB Spade  
D Rodespaten  
RUS Заступ

CZ Lisovaný rýč kalená  
RO Hârleț cu coadă  
H Ásó, sajított-edzett  
E Pala

T



FLO

No.	type	<input type="checkbox"/>
35800	T	140

PL Szpadel  
GB Spade  
D Rodespaten  
RUS Заступ

CZ Lisovaný rýč kalená  
RO Hârleț cu coadă  
H Ásó, sajított-edzett  
E Pala

T



No.	type	<input type="checkbox"/>
35801	T	140

PL Szpadel  
GB Spade  
D Rodespaten  
RUS Заступ

CZ Lisovaný rýč kalená  
RO Hârlet cu coadă  
H Ásó, sajtolt-edzett  
E Pala



No.	type	
35803	DY	140

PL Szpadel  
GB Spade  
D Rodespaten  
RUS Заступ

CZ Lisovaný rýč kalená  
RO Hârlet cu coadă  
H Ásó, sajtolt-edzett  
E Pala



No.	type	
35806	DY	140

PL Szpadel drenarski, profilowany  
GB Roll formed drainage spade  
D Drainagespaten, profiliert  
RUS Лопата дренажная цельноштампованная

CZ Rýč drenážní profilovaný  
RO Sapă drenaj profilată  
H Profilozott drénező ásó  
E Pala de drenaje perfilada



No.	type	
35808	DY	140

PL Lopata piaskowa  
GB Shovel  
D Schaufel  
RUS Лопата совковая песочная

CZ Osazený rýč pískový  
RO Lopată pt. nisip  
H Homoklapát  
E Pala arena



No.	type	
35840	T	200

PL Szpadel  
GB Spade  
D Rodespaten  
RUS Заступ

CZ Lisovaný rýč kalená  
RO Hârlet cu coadă  
H Ásó, sajtolt-edzett  
E Pala



No.	type	
35805	DY	140

PL Szpadel drenarski, nitowany  
GB Riveted drainage spade  
D Drainagespaten, genietet  
RUS Лопата дренажная сборная

CZ Rýč drenážní nýtovaný  
RO Sapă drenaj nituit  
H Szegecseltt drénező ásó  
E Pala de drenaje remachada



No.	type	
35807	T	140

PL Lopata piaskowa  
GB Shovel  
D Schaufel  
RUS Лопата совковая песочная

CZ Osazený rýč pískový  
RO Lopată pt. nisip  
H Homoklapát  
E Pala arena



No.	type	
35839	DY	120

PL Lopata  
GB Shovel  
D Schaufel  
RUS Лопата

CZ Lopata  
RO Lopată  
H Homoklapát  
E Pala



No.	type	
35846	DY	250

PL Lopata węglowa  
GB Shovel  
D Kohlenschaufel  
RUS Лопата угольная

CZ Úhlový rýč číslo  
RO Lopată pt. cărbune  
H Szeneslapát  
E Pala carbón



No.	type	☐
35850	T	120

PL Lopata piaskowa  
GB Shovel  
D Schaufel  
RUS Лопата совковая песочная

CZ Osazený rýč pískový  
RO Lopată pt. nisip  
H Homoklapát  
E Pala arena



No.	L (cm)	type	☐
35842	135	P	100

PL Widły  
GB Digging fork  
D Grabegabel  
RUS Вилы свекловичные кованые

CZ Zahradnické vidlice  
RO Furcă pt. grădină  
H Vasvilla  
E Horca



FLO

No.	teeth / zęby	type	☐
35865	4	DY	140

PL Widły  
GB Digging fork  
D Grabegabel  
RUS Вилы свекловичные кованые

CZ Zahradnické vidlice  
RO Furcă pt. grădină  
H Vasvilla  
E Horca



No.	teeth / zęby	type	☐
35813	4	DY	100

PL Lopata węglowa  
GB Shovel  
D Kohlenschaufel  
RUS Лопата угольная

CZ Úhlový rýč číslo  
RO Lopată pt. cărbune  
H Szeneslapát  
E Pala carbón



No.	type	☐
35860	DY	90

PL Widły  
GB Digging fork  
D Grabegabel  
RUS Вилы свекловичные кованые

CZ Zahradnické vidlice  
RO Furcă pt. grădină  
H Vasvilla  
E Horca



FLO

No.	teeth / zęby	type	☐
35815	3	P	1
35816	4	P	1

PL Widły  
GB Digging fork  
D Grabegabel  
RUS Вилы свекловичные кованые

CZ Zahradnické vidlice  
RO Furcă pt. grădină  
H Vasvilla  
E Horca



FLO

No.	teeth / zęby	type	☐
35866	4	DY	140

PL Widły  
GB Digging fork  
D Grabegabel  
RUS Вилы свекловичные кованые

CZ Zahradnické vidlice  
RO Furcă pt. grădină  
H Vasvilla  
E Horca



No.	teeth / zęby	type	☐
35864	4	DY	140

FLO

PL Pazurki opravione  
GB Cultivator  
D Grubber  
RUS Рыхлитель садовый

CZ Kultivátor  
RO Cultivator  
H Kultivátor  
E Escarificador

125 cm P



No.	type	<input type="checkbox"/>
35763	P	5

PL Grabie  
GB Rake  
D Rechen  
RUS Грабли

CZ Hrábě  
RO Greblă  
H Gereblye  
E Rastrillo

150 cm



No.	L (cm)	teeth / zęby	<input type="checkbox"/>
35779	150	12	150
35780	150	16	140

PL Grabie wachlarzowe metalowe  
GB Metal fan rake  
D Metall-Fächerbesen  
RUS Грабли для уборки листьев металлические  
CZ Kovové vějířové hrábě  
RO Greblă evantai de metal  
H Fém levélgereblye  
E Rastrillo de abanico de metal

530 mm



No.	L (mm)	<input type="checkbox"/>
99400	530	24

PL Motyczka z pazurkami  
GB Hoe + cultivator  
D Kleinhacke  
RUS Рыхлитель комбинированный

CZ Motyčka s hrabičkami  
RO Sapaliga + cultivator  
H Kerti villás kapa  
E Azadilla con escarificador

P



No.	type	<input type="checkbox"/>
35792	P	5

PL Grabie  
GB Rake  
D Rechen  
RUS Грабли

CZ Hrábě  
RO Greblă  
H Gereblye  
E Rastrillo

P



No.	teeth / zęby	type	<input type="checkbox"/>
35781	10	P	10
35782	12	P	10
35784	14	P	10
35783	16	P	10

PL Grabie wachlarzowe  
GB Spring rake  
D Landschaftsbesen  
RUS Грабли веерные

CZ Hrábičky  
RO Grebla de gradina  
H Kerti gereblye  
E Rastrillo de abanico de hojalata



No.	L (mm)	teeth / zęby	<input type="checkbox"/>
35785	435	23	12

PL Motyczka z pazurkami  
GB Hoe + cultivator  
D Kleinhacke  
RUS Рыхлитель комбинированный

CZ Motyčka s hrabičkami  
RO Sapaliga + cultivator  
H Kerti villás kapa  
E Azadilla con escarificador

P



No.	type	<input type="checkbox"/>
35764	P	5

PL Motyka  
GB Garden hoe  
D Garten handhacke  
RUS Тяпка

CZ Motyčka  
RO Sapaliga  
H Kerti kapa  
E Azadilla

P



No.	working part width / szer. części roboczej (cm)	type	<input type="checkbox"/>
35776	16	P	5

PL Motyka  
GB Garden hoe  
D Garten handhacke  
RUS Тяпка

CZ Motyčka  
RO Sapaliga  
H Kerti kapa  
E Azadilla



No.	working part width / szer. części roboczej (cm)	type	
35770	17	P	5

PL Motyka  
GB Garden hoe  
D Garten handhacke  
RUS Тяпка

CZ Motyčka  
RO Sapaliga  
H Kerti kapa  
E Azadilla



No.	working part width / szer. części roboczej (cm)	type	
35777	17	P	5

PL Wertykulator do trawy  
GB Grass cultivator  
D Schneidrechen  
RUS Грабли азрационные

CZ Kultivátor oboustranný  
RO Cultivator  
H Kétoldalas talajazító, gyephez  
E Cultivador de dos lados



No.	L (mm)	
35700	380	5/10

PL Grabie  
GB Rake  
D Rechen  
RUS Грабли

CZ Hrábě  
RO Greblă  
H Gereblye  
E Rastrillo



No.	L (mm)	teeth / zęby	
35755	360	14	20

PL Motyka  
GB Garden hoe  
D Garten handhacke  
RUS Тяпка

CZ Motyčka  
RO Sapaliga  
H Kerti kapa  
E Azadilla



No.	working part width / szer. części roboczej (cm)	type	
35773	12	P	500
35774	14	P	250

PL Grabie plastikowe  
GB Plastic rake  
D Plasteharken  
RUS Грабли пластиковые

CZ Plastové hrábě  
RO Greblă de plastic  
H Műanyag gereblye  
E Rastrillo de plástico



No.	L (mm)	teeth / zęby	
35788	550	16	10
35789	590	18	10

PL Grabie  
GB Rake  
D Rechen  
RUS Грабли

CZ Hrábě  
RO Greblă  
H Gereblye  
E Rastrillo



No.	L (mm)	teeth / zęby	
35750	270	12	48
35751	340	14	28

PL Grabie wachlarzowe  
GB Spring rake  
D Landschaftsbesen  
RUS Грабли веерные

CZ Hraňičky  
RO Grebla de gradina  
H Kerti gereblye  
E Rastrillo de abanico de hojalata



No.	L (mm)	teeth / zęby	
35786	435	23	10



PL Grabie wachlarzowe  
GB Spring rake  
D Landschaftsbesen  
RUS Грабли веерные

CZ Hrabičky  
RO Grebla de gradina  
H Kerti gereblye  
E Rastrillo de abanico de hojalata

460 mm



No.	L (mm)	teeth / zęby	
35787	455	20	10

PL Grabie wachlarzowe metalowe  
GB Metal fan rake  
D Metall-Fächerbesen  
RUS Грабли для уборки листьев металлические  
CZ Kovové vějířové hrábě  
RO Greblă evantai de metal  
H Fém levélgereblye  
E Rastrillo de abanico de metal

430 mm



No.	L (mm)	
99390	430	40

PL Grabie wachlarzowe metalowe  
GB Metal fan rake  
D Metall-Fächerbesen  
RUS Грабли для уборки листьев металлические  
CZ Kovové vějířové hrábě  
RO Greblă evantai de metal  
H Fém levélgereblye  
E Rastrillo de abanico de metal

425 mm



No.	L (mm)	
99401	425	60

PL Obsypnik  
GB Cultivator  
D Häufiger  
RUS Культиватор

CZ Zасыпávač  
RO Cultivator  
H Kultivátor  
E Arado

190 mm



No.	L (mm)	
35710	190	5/15

PL Grabie wachlarzowe  
GB Spring rake  
D Landschaftsbesen  
RUS Грабли веерные

CZ Hrabičky  
RO Grebla de gradina  
H Kerti gereblye  
E Rastrillo de abanico de hojalata

460 mm



No.	L (mm)	teeth / zęby	
35790	435	20	20
35791	580	27	20

PL Grabie wachlarzowe metalowe  
GB Metal fan rake  
D Metall-Fächerbesen  
RUS Грабли для уборки листьев металлические  
CZ Kovové vějířové hrábě  
RO Greblă evantai de metal  
H Fém levélgereblye  
E Rastrillo de abanico de metal

460 mm



No.	L (mm)	
99391	460	50

PL Pazurki  
GB Cultivator  
D Grubber  
RUS Рыхлитель садовый

CZ Kultivátor  
RO Cultivator  
H Kultivátor  
E Escarificador

160 mm



No.	L (mm)	
35793	100	60
35794	130	60

PL Motyczka  
GB Hoe  
D Garten handhacke  
RUS Мотыжка

CZ Motyčka  
RO Săpăligă  
H Kerti kapa  
E Azadilla

160 mm



No.	L (mm)	
35775	160	30

PL Motyczka z pazurkami  
GB Hoe + cultivator  
D Kleinhacke  
RUS Рыхлитель  
комбинированный

CZ Motyčka s hrabičkami  
RO Sapaliga + cultivator  
H Kerti villás kapa  
E Azadilla con escarificador

80 mm



FLO

No.	L (mm)	
35760	80	60

PL Łopata do śniegu  
GB Plastic shovel for snow  
D Kunststoff-schneeschaufel  
RUS Лопата снеговая

CZ Lopata na sněh  
RO Lopată pt. zăpadă  
H Műanyag hólapát  
E Pala para nieve



No.		
35880		180

PL Łopata do śniegu  
GB Plastic shovel for snow  
D Kunststoff-schneeschaufel  
RUS Лопата снеговая

CZ Lopata na sněh  
RO Lopată pt. zăpadă  
H Műanyag hólapát  
E Pala para nieve



VOREL

No.	mm	
35889	400x430	180

PL Miotta  
GB Broom  
D Strassenbesen  
RUS Метла

CZ Metla  
RO Matura  
H Partvis  
E Cepillo pelo largo

SORGO



No.	L (mm)	
35911	1150x22	140

PL Motyczka z pazurkami  
GB Hoe + cultivator  
D Kleinhacke  
RUS Рыхлитель  
комбинированный

CZ Motyčka s hrabičkami  
RO Sapaliga + cultivator  
H Kerti villás kapa  
E Azadilla con escarificador

70 mm



FLO

No.	L (mm)	
35795	70	60

PL Łopata do śniegu  
GB Plastic shovel for snow  
D Kunststoff-schneeschaufel  
RUS Лопата снеговая

CZ Lopata na sněh  
RO Lopată pt. zăpadă  
H Műanyag hólapát  
E Pala para nieve



VOREL

No.	mm	
35881	330x390	270

PL Skuwacz do lodu  
GB Ice breaker  
D Eishammer  
RUS Прибор для скобления льда

CZ Skováč na led  
RO Spărgător pt. gheață  
H Jégtörő  
E Rompehielo mango



VOREL

No.		
35878		125

PL Miotta  
GB Broom  
D Strassenbesen  
RUS Метла

CZ Metla  
RO Matura  
H Partvis  
E Cepillo pelo largo

NYLON



FLO

No.	L (mm)	
35912	1200x22	15

PL Miotła  
GB Broom  
D Strassenbesen  
RUS Метла

CZ Metla  
RO Matura  
H Partvis  
E Cepillo pelo largo



No.	L (mm)	
35893	300	12
35894	400	12
35895	500	12

PL Miotła  
GB Broom  
D Strassenbesen  
RUS Метла

CZ Metla  
RO Matura  
H Partvis  
E Cepillo pelo largo



No.	bristle length / długość włosia (mm)	
35905	275	12

PL Miotła  
GB Broom  
D Strassenbesen  
RUS Метла

CZ Metla  
RO Matura  
H Partvis  
E Cepillo pelo largo



No.	bristle length / długość włosia (mm)	
35908	210	8

PL Kosa kuta  
GB Forged scythe  
D Sensenklinge geschmiedet  
RUS Коса

CZ Kosa kovaná  
RO Lama de coasa  
H Kovácsolt kasza  
E Guadana forjada



No.	type	
35824	No 6	25
35826	No 7	25
35828	No 8	25

PL Miotła  
GB Broom  
D Strassenbesen  
RUS Метла

CZ Metla  
RO Matura  
H Partvis  
E Cepillo pelo largo



No.	L (mm)	
35899	250	12

PL Miotła  
GB Broom  
D Strassenbesen  
RUS Метла

CZ Metla  
RO Matura  
H Partvis  
E Cepillo pelo largo



No.	bristle length / długość włosia (mm)	
35906	135	12

PL Sierp  
GB Sickle  
D Sichel  
RUS Сепр

CZ Srp  
RO Secera  
H Sárló  
E Hoz



No.		
35832		30

PL Klepadło do kos  
GB Stake for scythe  
D Dengelamboss für sensen  
RUS Бабка для отбивки кос (наковальня)

CZ Naklepávací kovadlinka  
RO Inel de stângere - pt. coasă  
H Kaszarögztű gyűrű  
E Anillo para guadanás



No.		
35821		30

PL Pierścień do kosy  
GB Ring for scythe  
D Befestigungsring für sense verzinkt  
RUS Кольцо косное оцинкованное

CZ Kroužek na kosu  
RO Bratară galvanizată pt. coasă  
H Kaszarögzítő gyűrű  
E Anillo para guadana



FLO

No.	35823	30
-----	-------	----

PL Trzonek do kosy  
GB Wooden handle for scythe  
D Sensenstiel  
RUS Косовище деревянное

CZ Násada na kosu  
RO Coada de coasă  
H Kaszányél  
E Astil para guadanas



No.	L (cm)	10
35830	174	10

PL Trzonek do lopaty  
GB Wooden handle for shovel  
D Schaufelstiel gerade  
RUS Черенок для лопаты

CZ Násada na lopatu  
RO Coada din lemn  
H Lapátnyél  
E Astil para pala



No.	L (cm)	type	10
99410	130	P	10

PL Trzonek do miotły ulicznej  
GB Wooden handle for broom  
D Stiel für einen Straßenbesen  
RUS Черенок для метлы

CZ Násada na silniční metlu  
RO Coada mătură cu filet  
H Utcasprű nyél  
E Palo de escoba de calle



No.	L (cm)	25
99420	125	25

PL Klin drewniany do kosy  
GB Wedge for scythe  
D Holzkeil für sensen  
RUS Клин деревянный для косы

CZ Klin dřevěný na kosu  
RO Pană de lemn pt. coasă  
H Faék kaszához  
E Cuna de madera para guadanas



No.	35831	12/144
-----	-------	--------

PL Trzonek uniwersalny  
GB Wooden handle  
D Universalstiel  
RUS Черенок для грабель

CZ Násada univerzální  
RO Coada din lemn  
H Univerzálnis nyél  
E Astil universal



No.	L (cm)	Ø (mm)	type	25
99403	100	28	P	25
99404	110	28	P	25
99402	130	28	P	25
99408	150	28	P	25

PL Trzonek do grabi wachlarzowych  
GB Wooden handle  
D Schaufelstiel P-Griff  
RUS Черенок для лопат

CZ Násada na lopatu  
RO Coada de lopată cu maner  
H Lapátnyél  
E Astil para pala



No.	L (cm)	Ø (mm)	type	25
99415	130	21	P	25

PL Trzonek do miotły z gwintem  
GB Broom handle with thread  
D Besenstiel, holz, mit gewinde  
RUS Черенок для метлы с резьбой

CZ Násada na metlu se závitem  
RO Coada de mătură cu filet  
H Menetes seprűnyél  
E Astil para escoba con rosca



No.	L (cm)	type	Ø (mm)	25
99416	120	P	22	25

PL Trzonek do miotły z gwintem  
GB Broom handle with thread  
D Besenstiel, Holz, mit Gewinde  
RUS Черенок для метлы с резьбой

CZ Násada na metlu se závitem  
RO Coadă de mătură cu filet  
H Menetes seprűnyél  
E Astil para escoba con rosca



No.	L (cm)	type	
99418	120	P	25

PL Trzonek do szpadla  
GB Handle „T” for spade  
D Spadefstiel T-griff  
RUS Черенок для лопаты

CZ Násada na ryč  
RO Coadă din lemn  
H Ásónyél  
E Astil para pala



No.	L (cm)	type	
99407	90	T	10

PL Trzonek  
GB Wooden handle  
D Schaufelstiel D-Griff  
RUS Черенок для лопат

CZ Násada na lopatu  
RO Coadă de lopată cu maner  
H Lapátnyél  
E Astil para pala



No.	L (cm)	type	
99412	90	DY	10

PL Trzonek do toporka  
GB Wooden handle for hammer-axe  
D Beilstiel  
RUS Черенок для топора

CZ Násada na sekeru - kálač  
RO Coadă de topor  
H Ácsszekere nyél  
E Astil para hacha con martillo



No.	L (cm)	for head / do obucha (kg)	
99425	36	0.6	75
99426	40	0.6	25

PL Trzonek metalowy z gwintem  
GB Steel handle with thread  
D Besenstiel mit Gewinde  
RUS Черенок с резьбой

CZ Násada na metlu se závitem  
RO Coadă cu filet  
H Menetes seprűnyél  
E Astil para escoba con rosca



No.	L (cm)	Ø (mm)	
99419	116	22	25

PL Trzonek do łopaty  
GB Wooden handle for shovel  
D Schaufelstiel gerade  
RUS Черенок для лопаты

CZ Násada na lopatu  
RO Coadă din lemn  
H Lapátnyél  
E Astil para pala



No.	L (cm)	type	
99409	115	T	10

PL Trzonek  
GB Wooden handle  
D Schaufelstiel D-Griff  
RUS Черенок для лопат

CZ Násada na lopatu  
RO Coadă de lopată cu maner  
H Lapátnyél  
E Astil para pala



No.	L (cm)	type	
99413	90	DY	10

PL Trzonek do siekiero-mlota  
GB Handle for hammer-axe  
D Stiel für Hammeraxt  
RUS Черенок для топора

CZ Násada na sekeru  
RO Coadă din lemn  
H Baltányél  
E Astil para hachuela



No.	L (cm)	for head / do obucha (kg)	
99405	90	2.5	10
99406	90	4.0	10

PL Trzonek do siekiery CZ Topórko do sekery  
 GB Axe handle RO Cap de topor  
 D Axtstiel H Baltanyél  
 RUS Рукоятка топора E Astil de hacha



No.	L (cm)	for head / do obucha (kg)	
99427	50	1.0	25
99428	60	1.0-1.25	25
99429	70	1.25-1.80	25

PL Trzonek do młotka CZ Topórko do kładiva  
 GB Hammer handle RO Cap de ciocan  
 D Hammerstiel H Kalapácsnyél  
 RUS Рукоятка молотка E Astil de martillo



No.	L (cm)	for head / do obucha (kg)	
99435	28	0.1-0.3	65
99436	32	0.3-0.7	65
99438	36	0.7-1.5	65
99440	40	0.8-2.0	50
99442	50	2.0-3.0	50
99443	60	3.0-4.0	25
99444	70	4.0-6.0	25
99445	80	5.0-8.0	25
99446	90	8.0-10	10

PL Opryskiwacz ciśnieniowy  
 GB Pressure sprayer  
 D Drucksprüher  
 RUS Ручной давятельный  
 опрыскиватель  
 CZ Ruční tlakový postřikovač  
 RO Pulverizator de mana  
 H Permetező kézi  
 E Rociador de presión

0.2 MPa



FLO

No.	l	
89515	5.0	6
89518	8.0	6

PL Trzonek do siekiery CZ Topórko do sekery  
 GB Axe handle RO Cap de topor  
 D Axtstiel H Baltanyél  
 RUS Рукоятка топора E Astil de hacha

80 cm



No.	L (cm)	for head / do obucha (kg)	
99430	80	1.8-2	25

PL Spryskiwacz ciśnieniowy ręczny  
 GB Pressure sprayer  
 D Drucksprüher  
 RUS Ручной опрыскиватель  
 CZ Ruční tlakový postřikovač  
 RO Vermorel  
 H Permetező kézi  
 E Rociador de presión, de mano



FLO

No.	l	
89507	1.0	20
89508	1.5	15
89509	2.0	15

PL Opryskiwacz ciśnieniowy  
 GB Pressure sprayer  
 D Drucksprüher  
 RUS Ручной давятельный  
 опрыскиватель  
 CZ Ruční tlakový postřikovač  
 RO Pulverizator de mana  
 H Permetező kézi  
 E Rociador de presión

8L

0.2 MPa



FLO

No.	l	
89520	8.0	6

- PL Opryskiwacz ciśnieniowy plecakowy
- GB Pressure sprayer
- D Rücken-Drucksprüher
- RUS Опрыскиватель ранцевый
- CZ Tlakový postřikovač zádový
- RO Pulverizator portabil
- H Permetező hátí
- E Rociador de presión tipo „mochila”

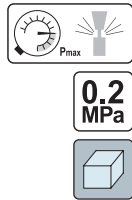

No.	l	
89525	15.0	1

- PL Pompka do spryskiwacza
- GB Pump for pressure sprayer
- D Druckpumpe für Drucksprüher
- RUS Насос на опрыскиватели
- CZ Pumpa do postřikovače
- RO Pompa pt. vermores
- H Szivattyú esőztetőhöz
- E Bomba para el rociador



No.	for / dla	
89536	89515; 89518; 89520	60

- PL Zestaw końcówek rozpylających
- GB Spray nozzle set
- D Spritzdüsenatz
- RUS Форсунки сменные для опрыскивателей
- CZ Sada rozprašovacích koncovek
- RO Set racorduri vermores
- H Porlasztó tömlővég készlet
- E Juego de boquillas rociadores



No.	
89538	100

- PL Pistolet do opryskiwacza
- GB Shower spray gun
- D Spritzpistole
- RUS Пистолет для опрыскивателей
- CZ Rozprašovací pistole na vodu
- RO Pistol pt. stropit
- H Locsoló pisztoly
- E Pistola de pulverización ajustable



No.	
89540	200

- PL Opryskiwacz ciśnieniowy plecakowy
- GB Pressure sprayer
- D Rücken-Drucksprüher
- RUS Опрыскиватель ранцевый
- CZ Tlakový postřikovač zádový
- RO Pulverizator portabil
- H Permetező hátí
- E Rociador de presión tipo „mochila”

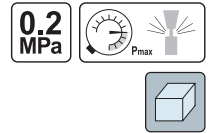

No.	l	
89526	15.0	1
89528	20.0	1

- PL Końcówka rozpylająca do spryskiwacza
- GB Straight nozzle for pressure sprayer
- D Sprühdüse für Drucksprüher
- RUS Распылитель на опрыскиватели
- CZ Rozprašovací koncovka k postřikovači
- RO Doza pt. vermores
- H Porlasztó tömlővég esőztetőhöz
- E Puna de atomización para rociador



No.	for / dla	
89537	89515; 89518; 89520	300

- PL Pistolet do opryskiwacza
- GB Shower spray gun
- D Spritzpistole
- RUS Пистолет для опрыскивателей
- CZ Rozprašovací pistole na vodu
- RO Pistol pt. stropit
- H Locsoló pisztoly
- E Pistola de pulverización ajustable



No.	
89539	200

- PL Lanza z włókna szklanego
- GB Fibreglass spray lance
- D Fibreglaslanze
- RUS Трубка фиберглассовая
- CZ Násadec postřikovače ze skleněného vlákna
- RO Lance din fibra de sticla
- H Üveggyapot lándzsa
- E Lanza de fibra de vidrio



No.	L (cm)	Ø (mm)	
89541	80	8	250

- PL Lanca teleskopowa  
GB Telescopic handle  
D Teleskoplanze  
RUS Штанга телескопическая для опрыскивателя
- CZ Násadec teleskopický  
RO Maner telescopic  
H Teleszkópos lándzsa  
E Lanza telescópica

70-118 cm



No.	L (cm)	
89542	70-118	100

- PL Zestaw uszczelek do spryskiwaczy  
GB Set of gaskets for pressure sprayer  
D Dichtungssatz für Drucksprüher  
RUS Набор прокладок для опрыскивателя

- CZ Sada těsnění k postřikovači  
RO Set de garnituri pt. vermores  
H Tömítéskészlet esőztetőhöz  
E Juego de juntas para rociadores



No.	for / dla	
89545	89515; 89518; 89520	500

- PL Zestaw uszczelek do spryskiwaczy  
GB Set of gaskets for pressure sprayer  
D Dichtungssatz für Drucksprüher  
RUS Набор прокладок для опрыскивателя

- CZ Sada těsnění k postřikovači  
RO Set de garnituri pt. vermores  
H Tömítéskészlet esőztetőhöz  
E Juego de juntas para rociadores



No.	for / dla	
89547	89526	500

- PL Podkaszarka elektryczna  
GB Electric grass trimmer  
D Elektrische Untergrasmähmaschine  
RUS Триммер электрический  
CZ Elektrická sekačka na trávu  
RO Cositoare pt. iarba  
H Elektromos fűnyíró  
E Segadora



$L_{pA} = 82,3 \pm 3,0$  dB;  $L_{wA} = 91,8 \pm 2,29$  dB;  $a_b = 4,549 \pm 1,5$  m/s<sup>2</sup>

No.	W	min-1	Ø (mm)	
79456	250	14000	200	6/12

- PL Przyłącze 4-dyszowe  
GB 4-nozzle connector  
D Querlanze mit 4 Düsen  
RUS Штанга с 4 форсунками для опрыскивателей (вертикальная)
- CZ Připojka 4-trysková  
RO Sistem irigații  
H 4-fúvókás csatlakozó  
E Conexión de cuatro surtidores

645 mm



No.	L (mm)	
89543	645	100

- PL Zestaw uszczelek do spryskiwaczy  
GB Set of gaskets for pressure sprayer  
D Dichtungssatz für Drucksprüher  
RUS Набор прокладок для опрыскивателя

- CZ Sada těsnění k postřikovači  
RO Set de garnituri pt. vermores  
H Tömítéskészlet esőztetőhöz  
E Juego de juntas para rociadores



No.	for / dla	
89546	89525	500



- PL Podkaszarka elektryczna  
GB Electric trimmer  
D Elektro-Rasentrimmer  
RUS Электрический триммер  
CZ Elektrická sekačka  
RO Cositoare electrică  
H Elektromos fűnyíró  
E Segadora eléctrica



$L_{pA} = 74,4 \pm 1,94$  dB;  $L_{wA} = 94,1 \pm 1,94$  dB;  $a_b = 0,794 \pm 1,5$  m/s<sup>2</sup>



No.	W	min-1	Ø (mm)	
79467	500	10500	280	4





- PL Akumulatorowe nożyce do trawy i krzewów  
 GB Cordless grass and shrub shears  
 D Akkuschere mit Gras- und Strauchmesser  
 RUS Аккумуляторные ножницы для травы и кустов  
 CZ Akumulátorové nůžky na trávu a keře  
 RO Trimmer cu acumulator pt. iarba si gard viu  
 H Foarfecele cu acumulator pt. tăiat iarba  
 E Tijeras a batería para hierba y arbustos

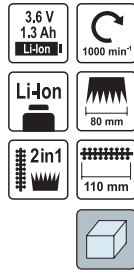

$L_{pA} = 74,6 \pm 3,0$  dB;  $L_{wA} = 86,4 \pm 3,0$  dB;  $a_n = 1,63 \pm 1,5$  m/s<sup>2</sup>

No.	min-1	Box
79500	1000	8

- PL Elektryczne nożyce do żywoplotu  
 GB Hedge shears  
 D Heckenscheren  
 RUS Ножницы для живой изгороди  
 CZ Nůžky na živý plot  
 RO Foarfece pt. gard viu  
 H Sövényvágó olló  
 E Tijera para vallado

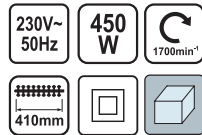

$L_{pA} = 81,6 \pm 3$  dB;  $L_{wA} = 101,6 \pm 3$  dB;  $a_n = 5,328 \pm 1,5 / 6,1214 \pm 1,5$  m/s<sup>2</sup>

No.	W	min-1	L (mm)	Box
79442	450	1700	410	4

- PL Nożyce do żywoplotu  
 GB Hedge shears  
 D Heckenscheren  
 RUS Ножницы для живой изгороди  
 CZ Nůžky na živý plot  
 RO Foarfece pt. gard viu  
 H Sövényvágó olló  
 E Tijera para vallado



$L_{pA} = 78,58 \pm 1,489$  dB;  $L_{wA} = 98,54 \pm 1,489$  dB;  $a_n = 3,272 \pm 1,5 / 3,435 \pm 1,5$  m/s<sup>2</sup>

No.	W	min-1	L (mm)	Box
79448	550	1700	510	4

- PL Akumulatorowe nożyce do trawy i krzewów  
 GB Cordless grass and shrub shears  
 D Akkuschere mit Gras- und Strauchmesser  
 RUS Аккумуляторные ножницы для травы и кустов  
 CZ Akumulátorové nůžky na trávu a keře  
 RO Trimmer cu acumulator pt. iarba si gard viu  
 H Foarfecele cu acumulator pt. tăiat iarba  
 E Tijeras a batería para hierba y arbustos

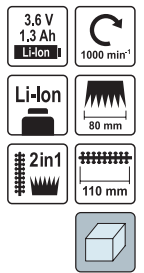

$L_{pA} = 74,6 \pm 3,0$  dB;  $L_{wA} = 86,4 \pm 3,0$  dB;  $a_n = 1,63 \pm 1,5$  m/s<sup>2</sup>

No.	min-1	Box
79501	1000	8

- PL Nożyce do żywoplotu  
 GB Hedge shears  
 D Heckenscheren  
 RUS Ножницы для живой изгороди  
 CZ Nůžky na živý plot  
 RO Foarfece pt. gard viu  
 H Sövényvágó olló  
 E Tijera para vallado



$L_{pA} = 75,2 \pm 0,6$  dB;  $L_{wA} = 95,2 \pm 0,6$  dB;  $a_n = 2,840 \pm 1,5$  m/s<sup>2</sup>

No.	W	min-1	L (mm)	Box
79444	520	1600	510	4

- PL Piłnik okrągły do łańcuchów  
 GB Chain saw file  
 D Runde Kettenfeile  
 RUS Цилиндрический напильник для цепей  
 CZ Kulatý pilník na řetězy  
 RO Piłă rotundă pt. lanțuri  
 H Láncvágó körfűrész  
 E Lima redonda para cadenas



No.	L (mm)	Ø (mm)	pcs / packing	Box
79861	200	4.0	3	200
79862	200	4.5	3	200
79863	200	4.8	3	200

- PL Prowadnik do pilnika do łańcuchów  
 GB Guide for chain saw file  
 D Führung für die Kettenfeile  
 RUS Направляющая для напильника для цепей  
 CZ Vedení pro pilník na řetězy  
 RO Ghidaj pt. pila pt. lanțuri  
 H Megvezető a láncfűrészhez  
 E Guía de lima para cadenas



FLO

No.	chain pitch / podziałka łańcucha	Ø (mm)	
79865	3/8 picco	4.0	50/150
79866	microlite	4.5	50/150
79867	.325	4.8	50/150

- PL Glowica żyłkowa  
 GB Line head  
 D Trimmerkopf  
 RUS Головка с леской  
 CZ Strunová hlava  
 RO Cap cu cablu  
 H Damil fej  
 E Cabezal de hilo

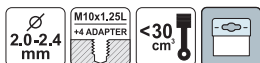

FLO

No.	Ø (mm)	
79550	2.0-2.4	10/40

- PL Glowica żyłkowa  
 GB Line head  
 D Trimmerkopf  
 RUS Головка с леской  
 CZ Strunová hlava  
 RO Cap cu cablu  
 H Damil fej  
 E Cabezal de hilo



FLO

No.	Ø (mm)	
79552	2.4-2.7	10/40

- PL Żyłka tnąca  
 GB Grass trimmer line  
 D Mähfaden  
 RUS Леска для триммера  
 CZ Struna do strunové sekačky  
 RO Furtun gradina  
 H Damil szegélynyíró géphez  
 E Hilo de cortar



FLO

No.	Ø (mm)	L (m)	profil	
89401	1.3	10	O	20/240
89402	1.6	10	O	20/240
89403	2.0	10	O	20/240
89404	2.4	10	O	12/144
89405	2.6	10	O	12/144
89406	3.0	10	O	12/144

- PL Klucz uniwersalny do narzędzi spalinowych  
 GB Universal wrench for gasoline machines  
 D Universalschlüssel für Benzin Maschinen  
 RUS Универсальный ключ для бензинового инструмента  
 CZ Univerzální klíč pro benzínové stroje  
 RO Cheie universală pt. mașini pe benzină  
 H Kulccsal benzin eszköz  
 E Llave universal para máquinas de gasolina



FLO

No.	
79869	20/160

- PL Glowica żyłkowa  
 GB Line head  
 D Trimmerkopf  
 RUS Головка с леской  
 CZ Strunová hlava  
 RO Cap cu cablu  
 H Damil fej  
 E Cabezal de hilo

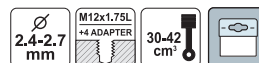

FLO

No.	Ø (mm)	
79551	2.4-2.7	10/40

- PL Glowica żyłkowa  
 GB Line head  
 D Trimmerkopf  
 RUS Головка с леской  
 CZ Strunová hlava  
 RO Cap cu cablu  
 H Damil fej  
 E Cabezal de hilo



FLO

No.	Ø (mm)	for / dla	
79468	1.2	79467	20/100

- PL Żyłka tnąca  
 GB Grass trimmer line  
 D Mähfaden  
 RUS Леска для триммера  
 CZ Struna do strunové sekačky  
 RO Furtun gradina  
 H Damil szegélynyíró géphez  
 E Hilo de cortar



FLO

No.	Ø (mm)	L (m)	profil	
89441	2.0	120	O	27
89442	2.4	90	O	27
89443	2.6	70	O	27
89444	3.0	56	O	27
89445	3.3	45	O	27

- PL Żyłka tnąca
- GB Grass trimmer line
- D Mähfaden
- RUS Леска для триммера
- CZ Struna do strunové sekačky
- RO Furtun gradina
- H Damil szegélynyíró géphez
- E Hilo de cortar



No.	Ø (mm)	L (m)	profil	
89411	1.3	10	□	20/240
89412	1.6	10	□	20/240
89413	2.0	10	□	20/240
89414	2.4	10	□	12/144
89415	2.6	10	□	12/144
89416	3.0	10	□	12/144

- PL Żyłka tnąca
- GB Grass trimmer line
- D Mähfaden
- RUS Леска для триммера
- CZ Struna do strunové sekačky
- RO Furtun gradina
- H Damil szegélynyíró géphez
- E Hilo de cortar



No.	Ø (mm)	L (m)	profil	
89421	1.3	15	☆	24/288
89422	1.6	15	☆	20/240
89423	2.0	15	☆	16/192
89424	2.4	15	☆	12/144
89425	2.6	15	☆	12/144
89426	3.0	15	☆	10/120

- PL Żyłka tnąca
- GB Grass trimmer line
- D Mähfaden
- RUS Леска для триммера
- CZ Struna do strunové sekačky
- RO Furtun gradina
- H Damil szegélynyíró géphez
- E Hilo de cortar



EXTRANYL

No.	Ø (mm)	L (m)	profil	
89462	2.4	15	□	10/120
89463	2.7	15	□	10/120
89464	3.0	12	□	10/120

- PL Żyłka tnąca
- GB Grass trimmer line
- D Mähfaden
- RUS Леска для триммера
- CZ Struna do strunové sekačky
- RO Furtun gradina
- H Damil szegélynyíró géphez
- E Hilo de cortar

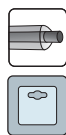

TRYGON

No.	Ø (mm)	L (m)	profil	
89470	2.4	15	△	10/120
89471	2.7	15	△	10/120
89472	3.0	12	△	10/120

- PL Żyłka tnąca
- GB Grass trimmer line
- D Mähfaden
- RUS Леска для триммера
- CZ Struna do strunové sekačky
- RO Furtun gradina
- H Damil szegélynyíró géphez
- E Hilo de cortar



No.	Ø (mm)	L (m)	profil	
89452	2.4	90	□	16
89453	2.6	70	□	16
89454	3.0	56	□	16

- PL Żyłka tnąca
- GB Grass trimmer line
- D Mähfaden
- RUS Леска для триммера
- CZ Struna do strunové sekačky
- RO Furtun gradina
- H Damil szegélynyíró géphez
- E Hilo de cortar



No.	Ø (mm)	L (m)	profil	
89456	2.0	90	☆	9/27
89457	2.4	90	☆	9/27
89458	2.6	90	☆	9/27
89459	3.0	60	☆	9/27

- PL Żyłka tnąca
- GB Grass trimmer line
- D Mähfaden
- RUS Леска для триммера
- CZ Struna do strunové sekačky
- RO Furtun gradina
- H Damil szegélynyíró géphez
- E Hilo de cortar



EXTRANYL

No.	Ø (mm)	L (m)	profil	
89465	2.4	90	□	10/20
89466	2.7	70	□	10/20
89467	3.0	60	□	10/20

- PL Żyłka tnąca
- GB Grass trimmer line
- D Mähfaden
- RUS Леска для триммера
- CZ Struna do strunové sekačky
- RO Furtun gradina
- H Damil szegélynyíró géphez
- E Hilo de cortar

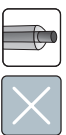

TRYGON

No.	Ø (mm)	L (m)	profil	
89473	2.4	90	△	10/20
89474	2.7	70	△	10/20
89475	3.0	60	△	10/20

- PL Żyłka tnąca  
 GB Grass trimmer line  
 D Mähfaden  
 RUS Леска для триммера  
 CZ Struna do strunové sekačky  
 RO Furtun gradina  
 H Damil szegélynyíró géphez  
 E Hilo de cortar



- PL Żyłka tnąca  
 GB Grass trimmer line  
 D Mähfaden  
 RUS Леска для триммера  
 CZ Struna do strunové sekačky  
 RO Furtun gradina  
 H Damil szegélynyíró géphez  
 E Hilo de cortar



FLO

SILENT

No.	Ø (mm)	L (m)	profil	
89478	1.6	15		20/240
89479	2.0	15		20/240
89480	2.4	15		10/120
89481	2.7	15		10/120
89482	3.0	12		10/120

FLO

SILENT

No.	Ø (mm)	L (m)	profil	
89483	2.0	90		10/20
89484	2.4	90		10/20
89485	2.7	70		10/20
89486	3.0	60		10/20

- PL Rękawice robocze  
 GB Working gloves  
 D Arbeitshandschuh  
 RUS Перчатки  
 CZ Pracovní rukavice  
 RO Mănuși  
 H Védőkesztyű  
 E Guantes



- PL Rękawice robocze  
 GB Working gloves  
 D Arbeitshandschuh  
 RUS Перчатки  
 CZ Pracovní rukavice  
 RO Mănuși  
 H Védőkesztyű  
 E Guantes



FLO

No.	
74100	12/300

FLO

No.	pairs / pary	size / rozmiar	
74110	1	9	12/300
74111	3	9	4/100

- PL Rękawice robocze  
 GB Working gloves  
 D Arbeitshandschuh  
 RUS Перчатки  
 CZ Pracovní rukavice  
 RO Mănuși  
 H Védőkesztyű  
 E Guantes



- PL Rękawice robocze  
 GB Working gloves  
 D Arbeitshandschuh  
 RUS Перчатки  
 CZ Pracovní rukavice  
 RO Mănuși  
 H Védőkesztyű  
 E Guantes



FLO

No.	size / rozmiar	
74125	8	12/300
74130	9	12/300
74131	10	12/300

FLO

No.	size / rozmiar	
74126	8	12/300
74132	9	12/300
74133	10	12/300

- PL Rękawice robocze  
 GB Working gloves  
 D Arbeitshandschuh  
 RUS Перчатки  
 CZ Pracovní rukavice  
 RO Mănuși  
 H Védőkesztyű  
 E Guantes



- PL Rękawice robocze  
 GB Working gloves  
 D Arbeitshandschuh  
 RUS Перчатки  
 CZ Pracovní rukavice  
 RO Mănuși  
 H Védőkesztyű  
 E Guantes



FLO

No.	size / rozmiar	
74127	8	12/300
74134	9	12/300
74135	10	12/300

FLO

No.	size / rozmiar	
74128	8	12/300
74136	9	12/300
74137	10	12/300

PL Rękawice ogrodnicze  
GB Gardening gloves  
D Arbeitshandschuh  
RUS Перчатки

CZ Pracovní rukavice  
RO Mănuși  
H Védőkesztyű  
E Guantes



No.	size / rozmiar	
74117	8	50/1000

PL Rękawice ogrodnicze  
GB Gardening gloves  
D Arbeitshandschuh  
RUS Перчатки

CZ Pracovní rukavice  
RO Mănuși  
H Védőkesztyű  
E Guantes



No.	size / rozmiar	
74123	8	50/1000

PL Rękawice ogrodnicze  
GB Gardening gloves  
D Arbeitshandschuh  
RUS Перчатки

CZ Pracovní rukavice  
RO Mănuși  
H Védőkesztyű  
E Guantes

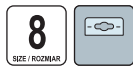

No.	size / rozmiar	
74115	8	50/1000

PL Rękawice ogrodnicze  
GB Gardening gloves  
D Arbeitshandschuh  
RUS Перчатки

CZ Pracovní rukavice  
RO Mănuși  
H Védőkesztyű  
E Guantes



No.	size / rozmiar	
74121	8	50/1000

PL Rękawice ogrodnicze  
GB Gardening gloves  
D Arbeitshandschuh  
RUS Перчатки

CZ Pracovní rukavice  
RO Mănuși  
H Védőkesztyű  
E Guantes



No.	size / rozmiar	
74113	8	50/1000

PL Kalosze damskie  
GB Women's rain boots  
D Damen - Gummistiefel  
RUS Галоши женские

CZ Dámské galoše  
RO Cizme damă  
H Női gumicsizma  
E Chanclas para mujer

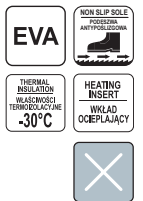

No.	size / rozmiar	model	
72831	36	LUNA	7
72832	37	LUNA	7
72833	38	LUNA	7
72834	39	LUNA	5
72835	40	LUNA	5
72836	41	LUNA	5

- PL Kalosze męskie  
 GB Men's rain boots  
 D Herren - Gummistiefel  
 RUS Галоши мужские
- CZ Pánské galoše  
 RO Cizme bărbați  
 H Férfi gumicsizma  
 E Chanclos para hombre



No.	size / rozmiar	model	
72840	41	PREDATOR XL	6
72841	42	PREDATOR XL	4
72842	43	PREDATOR XL	4
72843	44	PREDATOR XL	4
72844	45	PREDATOR XL	4
72845	46	PREDATOR XL	6
72846	47	PREDATOR XL	6

- PL Kalosze męskie  
 GB Men's rain boots  
 D Herren - Gummistiefel  
 RUS Галоши мужские
- CZ Pánské galoše  
 RO Cizme bărbați  
 H Férfi gumicsizma  
 E Chanclos para hombre



No.	size / rozmiar	model	
72858	41	GRAND BLACK	8
72859	42	GRAND BLACK	8
72860	43	GRAND BLACK	8
72861	44	GRAND BLACK	8
72862	45	GRAND BLACK	6
72863	46	GRAND BLACK	6
72864	47	GRAND BLACK	6

- PL Nakolanniki  
 GB Knee pads  
 D Knieschützer  
 RUS Наколенники
- CZ Chrániče kolen  
 RO Genunchiere  
 H Térdvédő  
 E Rodilleras



No.	
74610	20

- PL Kalosze damskie  
 GB Women's rain boots  
 D Damen - Gummistiefel  
 RUS Галоши женские
- CZ Dámské galoše  
 RO Cizme damă  
 H Női gumicsizma  
 E Chanclos para mujer



No.	size / rozmiar	model	
72850	36	RAINYNY BLACK	10
72851	37	RAINYNY BLACK	10
72852	38	RAINYNY BLACK	10
72853	39	RAINYNY BLACK	10
72854	40	RAINYNY BLACK	10

- PL Nakolanniki  
 GB Knee pads  
 D Knieschützer  
 RUS Наколенники
- CZ Chrániče kolen  
 RO Genunchiere  
 H Térdvédő  
 E Rodilleras



No.	
74600	50

- PL Nakolanniki  
 GB Knee pads  
 D Knieschützer  
 RUS Наколенники
- CZ Chrániče kolen  
 RO Genunchiere  
 H Térdvédő  
 E Rodilleras



No.	
74620	12/48

PL Nakolanniki CZ Chrániče kolen  
 GB Knee pads RO Genunchiere  
 D Knieschützer H Térdvédő  
 RUS Наколенники E Rodilleras



No.  
74622



50

PL Nakolanniki CZ Chrániče kolen  
 GB Knee pads RO Genunchiere  
 D Knieschützer H Térdvédő  
 RUS Наколенники E Rodilleras



VOREL

No.  
74601



24

PL Kask ochronny  
 GB Safety helmet  
 D Schutzhelm  
 RUS Каска защитная  
 CZ Ochranná přilba  
 RO Cască de protecție  
 H Védősisak  
 E Casco de protección

ABS



VOREL

No.	colour / kolor	
74190	○	40
74191	●	40
74192	●	40
74193	●	40
74194	●	40
74195	●	40

PL Nakolanniki CZ Chrániče kolen  
 GB Knee pads RO Genunchiere  
 D Knieschützer H Térdvédő  
 RUS Наколенники E Rodilleras



VOREL

No.  
74624



12/24

PL Nakolanniki CZ Chrániče kolen  
 GB Knee pads RO Genunchiere  
 D Knieschützer H Térdvédő  
 RUS Наколенники E Rodilleras



VOREL

No.  
74602



6/36

PL Nakolanniki CZ Chrániče kolen  
 GB Knee pads RO Genunchiere  
 D Knieschützer H Térdvédő  
 RUS Наколенники E Rodilleras



FLO

No.  
74623



12/24

PL Kask ochronny drwala  
 GB Lumberjack helmet  
 D Schutzhelm für Holzfäller  
 RUS Защитный шлем лесоруба  
 CZ Ochranná přilba pro dřevorubce  
 RO Cască de protecție pt. tăietor de lemne  
 H Favágó védősisak  
 E Casco de leñador

SNR  
23 dB

ABS



FLO

No.  
74201



8

- PL Przyłbica z osłoną wymienną  
 GB Face shield with PC visor  
 D Schweisserschutzhelm mit austauschbarer Abdeckung  
 RUS Шлем с заменяемой защитой  
 CZ Štít s vyměnitelným krytem  
 RO Vizieră cu protecție schimbabilă  
 H Arcvédő cserélhető pajzsral  
 E Antifaz con protección reemplazable



**VOREL**

No.		
74461		40

- PL Nauszniki przeciwhałasowe  
 GB Ear muff  
 D Gehörschutz  
 RUS Средства защиты слуха
- CZ Chrániče sluchu  
 RO Antifoane  
 H Fülvédőt  
 E Protectores de la vista



**VOREL**

No.		
74580		60

- PL Okulary ochronne  
 GB Safety glasses  
 D Schutzbrille  
 RUS Очки защитные открытые
- CZ Ochranné brýle  
 RO Ochelari pt. protecție  
 H Védőszemüveg  
 E Gafas protectoras



**VOREL**

No.	type	
74501	HF-111	12/240

- PL Okulary ochronne  
 GB Safety glasses  
 D Schutzbrille  
 RUS Очки защитные открытые
- CZ Ochranné brýle  
 RO Ochelari pt. protecție  
 H Védőszemüveg  
 E Gafas protectoras



**VOREL**

No.	type	
74503	DY-8525	15/150

- PL Przyłbica z osłoną wymienną i nausznikami przeciwhałasowymi  
 GB Face shield with steel mesh and ear muff  
 D Schweisserschutzhelm mit austauschbarer Abdeckung und Ohrenschützer gegen Lärm  
 RUS Шлем с заменяемой защитой и наушниками против шума  
 CZ Štít s vyměnitelným krytem a chrániči proti hluku  
 RO Vizieră cu protecție schimbabilă și căști de protecție antigomot  
 H Arcvédő cserélhető pajzsral és fülvédő kagylóval  
 E Antifaz con protección reemplazable y protectores de oídos



**VOREL**

No.		
74462		40

- PL Nauszniki przeciwhałasowe  
 GB Ear muff  
 D Gehörschutz  
 RUS Средства защиты слуха
- CZ Chrániče sluchu  
 RO Antifoane  
 H Fülvédőt  
 E Protectores de la vista



**VOREL**

No.		
74581		10/60

- PL Okulary ochronne  
 GB Safety glasses  
 D Schutzbrille  
 RUS Очки защитные открытые
- CZ Ochranné brýle  
 RO Ochelari pt. protecție  
 H Védőszemüveg  
 E Gafas protectoras



**VOREL**

No.	type	
74502	HF-110	12/240

- PL Okulary ochronne  
 GB Safety glasses  
 D Schutzbrille  
 RUS Очки защитные открытые
- CZ Ochranné brýle  
 RO Ochelari pt. protecție  
 H Védőszemüveg  
 E Gafas protectoras



**VOREL**

No.	type	
74504	DY-8526	15/150



PL Okulary ochronne  
GB Safety glasses  
D Schutzbrille  
RUS Очки защитные открытые

CZ Ochranné brýle  
RO Ochelari pt. protectie  
H Védőszemüveg  
E Gafas protectoras



No.	type	
74508	HF-103	10/120

PL Spodnie ogrodnicze  
GB Garden trousers  
D Gartenhosen  
RUS Брюки садовые  
CZ Zahradnické kalhoty  
RO Pantaloni pt. grădinărit  
H Kertész nadrág  
E Pantalón de jardinería



No.	size / rozmiar	
72900	S	10
72901	M	10
72902	L	10
72903	XL	10

PL Drut ogrodniczy  
GB Twist tie  
D Gartendraht  
RUS Проволока огородная

CZ Drát pro zahrádkáře  
RO Sârmă pt. grădină  
H Kötöződrót  
E Alambre de jardinero



No.	L (m)	
88801	50	12/48

PL Okulary ochronne  
GB Safety glasses  
D Schutzbrille  
RUS Очки защитные открытые

CZ Ochranné brýle  
RO Ochelari pt. protectie  
H Védőszemüveg  
E Gafas protectoras



No.	type	
74509	HF-105	10/100

PL Obrzeże trawnikowe, zielone  
GB Lawn edge  
D Gartenumrandung  
RUS Оградка для огорода

CZ Plastový okraj trávníku  
RO Gărdut plastic grădină  
H Ágyásszegély  
E Borde para jardín



No.	width / szerokość (mm)	L (m)	
88700	100	9	48
88701	150	9	36
88702	200	9	24

PL Obrzeże trawnikowe, brązowe  
GB Lawn edge  
D Gartenumrandung  
RUS Оградка для огорода

CZ Plastový okraj trávníku  
RO Gărdut plastic grădină  
H Ágyásszegély  
E Borde para jardín



No.	width / szerokość (mm)	L (m)	
88703	100	9	48
88704	150	9	36
88705	200	9	24

PL Drut ogrodniczy powlekany z obcinaczem  
GB Twist tie with cutter  
D Gartendraht, beschichtet, mit Abschneider  
RUS Проволока огородная с диспенсером

CZ Drát pro zahrádkáře potažený plastem s odřezávačem  
RO Sârmă pt. grădină izolată cu tăietor  
H Galvanizált kötöződrót, darabolóval  
E Alambre de jardinero cubierto con tronizador



No.	L (m)	
88805	30	24/144
88806	50	24/144

- PL Drut ogrodniczy w oslonie z pianki  
 GB Garden flexible tie  
 D Gartendraht, in einer Abdeckung aus Schaumstoff  
 RUS Проволока огородная покрытая пеной  
 CZ Drát pro zahrádkáře s pěnovým pláštěm  
 RO Sârmă pt. grădină cu izolație din spumă  
 H Kötöződrót, plasztik bevonattal  
 E Alambre de jardinero en cubierta de espuma



No.	L (m)	Icon
88809	10	40

- PL Miernik ogrodniczy  
 GB Soil survey instrument  
 D Gartenmessgerät  
 RUS Измеритель огородный  
 CZ Zahradnický měřicí přístroj  
 RO Aparat de măsurat grădinăresc  
 H Négyfunkciós, kerti mérőműszer  
 E Medidor de horticultor

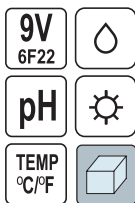

No.	Icon
89000	10

- PL Wiadro ocynkowane  
 GB Galvanized bucket  
 D Baueimer  
 RUS Ведро  
 CZ Vědro  
 RO Găleată  
 H Kőműves vödör  
 E Cubo



No.	l	Icon
89560	5	900
89561	7	450
89562	10	480
89563	12	360
89564	15	270

- PL Worki ogrodowe  
 GB Garden bags  
 D Gartensäcke  
 RUS Мешки для огорода
- CZ Zahradní pytle  
 RO Saci gunoi pt. grădină  
 D Kerti szemeteszsák  
 E Bolsas de jardín



No.	l	pcs packing	µm	Icon
09481	120	10	60	15

- PL Zestaw ogrodniczy do podwiązania roślin  
 GB Plant binding set  
 D Gartensatz zum Abbinden von Pflanzen  
 RUS Набор огородный для подвязки растений  
 CZ Souprava pro zahrádkáře k vyvazování rostlin  
 RO Set pt. grădină pt. legare plante  
 H Kertészeti szett növények felkötéséhez  
 E Juego para jardín para sujetar plantas

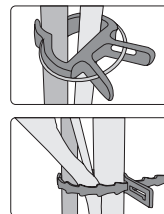

No.	pcs	Icon
88811	71	24

- PL Konewka dwustronna  
 GB Watering can  
 D Gießkanne  
 RUS Лейка  
 CZ Korvička  
 RO Stropitoare  
 H Locsolókanna  
 E Regadera



No.	l	colour / kolor	Icon
89490	1.0	Green	72

- PL Wiadro budowlane  
 GB Plastic bucket  
 D Baueimer  
 RUS Ведро строительное  
 CZ Stavební vědro  
 RO Găleată pt. construcții  
 H Kőműves vödör  
 E Cubo de obra



No.	l	Icon
06388	10	900
06390	12	680
06393	16	450
06392	20	390

- PL Worki ogrodowe z taśmą  
 GB Garden bags with cord  
 D Gartensäcke mit Band  
 RUS Мешки для огорода с лентой
- CZ Zahradní pytle zatahovací  
 RO Saci gunoi pt. grădină cu strangere  
 H Szalagos kerti szemeteszsák  
 E Bolsas de jardín con cinta



No.	l	pcs packing	µm	Icon
09480	60	10	60	12
09482	120	10	60	15

PL Drabina wielofunkcyjna  
 GB Multifold ladder  
 D Mehrzweckleiter  
 RUS Многофункциональная стремянка

CZ Multifunkční žebřík  
 RO Scară multifuncțională  
 H Többcéllú létra  
 E Escalera multipropósito

3.8 m max  
 STEPS STOPNIE x13  
 AI NYLON  
 max 150 kg

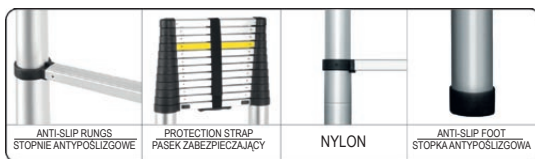
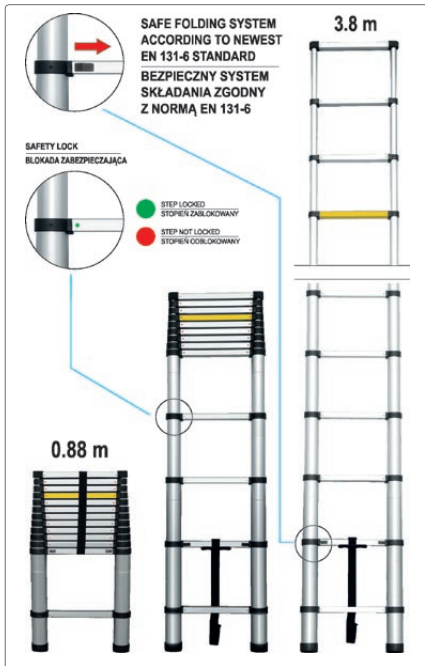

No. 17701 1

PL Podest do drabiny wielofunkcyjnej  
 GB Multifunction ladder platform  
 D Podest für die Multifunktionale Leiter  
 RUS Настил для лестницы трансформера  
 CZ Plošina pro víceúčelový žebřík  
 RO Platformă pt. scară multifuncțională  
 H Palló a multifunkciós létrához  
 E Descansillos para la escala multifuncional

830x295 mm 560x295 mm  
 ZINC PLATED ANTI-SLIP SURFACE  
 OCTYNKOWANE ANTYPOŚLIZGOWA POWIERZCHNIA  
 max 150 kg



No. 17705 for / dla 17704 5

PL Drabina wielofunkcyjna  
 GB Multifold ladder  
 D Mehrzweckleiter  
 RUS Многофункциональная стремянка  
 CZ Multifunkční žebřík  
 RO Scară multifuncțională  
 H Többcéllú létra  
 E Escalera multipropósito

3.4 m max  
 STEPS STOPNIE 4x3  
 16 kg  
 max 150 kg

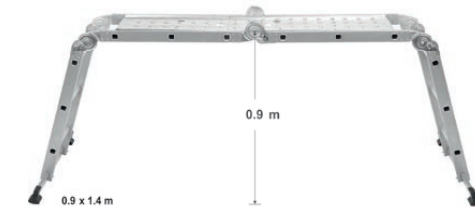
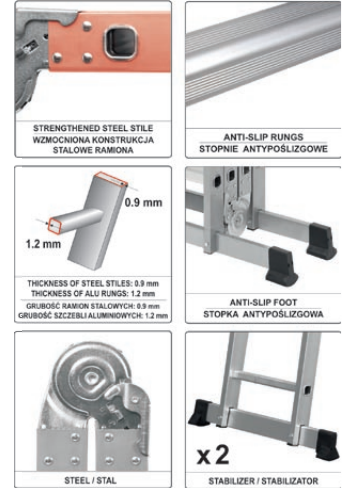

No. 17704 1

PL Sito do kompostu i żwiru  
 GB Compost and gravel sieve  
 D Sieb für Kompost und Kies  
 RUS Сито для компоста и гравия  
 CZ Prohazovací síto na kompost a štěrk  
 RO Cedazo para estiércol y guija  
 H Sítő komposzt és zsurá  
 E Rosta komposztáláshoz és sóderhez



No. 34949 cm size of eyelet / rozmiar oczka (mm) 30

PL Siatka zabezpieczająca rynny  
 GB Gutter mesh  
 D Schutzgitter für Rinnen  
 RUS Защитная сетка желоба

CZ Ochranná síť proti zanášení okapových žlabů  
 RO Plasă de protecție burlane  
 H Lombfógó háló  
 E Malla de protección para la canaleta



No.	
69850	30

PL Przedłużacz  
 GB Garden extension cable  
 D Gartenverlängerungskabel  
 RUS Электрорудинитель

CZ Prodlužovací kabel zahradní  
 RO Prelungitor electric  
 H Kerti hosszabbító  
 E Cable de extensión para jardín

No.	L (m)	
82671	10	10
82673	20	10
82675	30	5

PL Grill gazowy  
 GB Gas BBQ grill  
 D Der Gasgrill  
 RUS Газовый гриль

CZ Plynový gril  
 RO Grătarul cu gaz  
 H Gásgrill  
 E Barbacoa de gas



BBQ GRILL FOR LPG GRILL GAZOWY LPG  
 3 MAIN BURNERS 3 PALNIKI GŁÓWNE  
 CONNECTION SET INCLUDED WĄŻ I REGULATOR W ZESTAWIE  
 IGNITION IN THE KNOB ZAPALNIK W POKRĘTLE  
 GRILL SIZE / ROZMIAR RUSZTU 54 x 40 cm  
 1 SIDE BURNER 3 PALNIK BOCZNY  
 THERMO GAUGE TERMOMETR  
 SLIDING TRAY FOR WASTED FAT WYSUWANA TACA NA TLUSZCZ



No.	
99640	1

PL Siatka zabezpieczająca rynny z uchwytemi mocującymi  
 GB Gutter mesh with hooks  
 D Schutzgitter für Rinnen mit Spannvorrichtungen  
 RUS Защитная сетка желоба с монтажными ручками  
 CZ Ochranná síť proti zanášení okapových žlabů s úchytkami  
 RO Plasă de protecție burlane cu suporturi de protecție  
 H Lombfógó háló rögzítő fűlekekkel  
 E Malla de protección para la canaleta con mandriles de sujeción

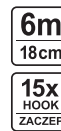

No.	
69851	30



PL Grill gazowy  
 GB Gas BBQ grill  
 D Der Gasgrill  
 RUS Газовый гриль

CZ Plynový gril  
 RO Grătarul cu gaz  
 H Gásgrill  
 E Barbacoa de gas



BBQ GRILL FOR LPG GRILL GAZOWY LPG  
 4 MAIN BURNERS 4 PALNIKI GŁÓWNE  
 CONNECTION SET INCLUDED WĄŻ I REGULATOR W ZESTAWIE  
 IGNITION IN THE KNOB ZAPALNIK W POKRĘTLE  
 WHEELS WITH A BRAKE KOLA Z HAMULCEM  
 GRILL SIZE / ROZMIAR RUSZTU 64 x 40 cm  
 1 SIDE BURNER 3 PALNIK BOCZNY  
 SIDE HANDLES UCHWYTY BOCZNE  
 THERMO GAUGE TERMOMETR  
 SLIDING TRAY FOR WASTED FAT WYSUWANA TACA NA TLUSZCZ



No.	
99641	1

- PL Grill ogrodowy z termometrem
- GB Big barrel BBQ with thermo gauge
- D BBQ Grillwagen XXL mit Temperaturanzeige
- RUS Барбекю-коптильня с термометром
- CZ Zahradní udíma s grilem
- RO Grătar cu afumătoare si termometru
- H Kültéri faszenes grill
- E Barbacoa Grill de carbón con soporte



No.  
99512

1

- PL Grill ogrodowy z termometrem
- GB Big barrel BBQ with thermo gauge
- D BBQ Grillwagen XXL mit Temperaturanzeige
- RUS Барбекю-коптильня с термометром
- CZ Zahradní udíma s grilem
- RO Grătar cu afumătoare si termometru
- H Kültéri faszenes grill
- E Barbacoa Grill de carbón con soporte



No.  
99514

1

- PL Grill węglowy
- GB Charcoal BBQ grill
- D Holzkohlegrill
- RUS Гриль-барбекю угольный
- CZ Gril na dřevěné uhlí
- RO Gratar carbuni
- H Faszén grill
- E Barbacoa de carbón y lena



No.  
99520

1

- PL Grill ogrodowy z termometrem i wędzarnią
- GB Big barrel BBQ with smoker
- D BBQ Grillwagen mit Temperaturanzeige und Räucherei
- RUS Барбекю-коптильня с термометром
- CZ Zahradní udíma s grilem
- RO Grătar cu afumătoare si termometru
- H Kültéri faszenes grill
- E Barbacoa Grill de carbón con soporte



No.  
99513

1

- PL Grill węglowy
- GB Charcoal BBQ grill
- D Holzkohlegrill
- RUS Гриль-барбекю угольный
- CZ Gril na dřevěné uhlí
- RO Gratar carbuni
- H Faszén grill
- E Barbacoa de carbón y lena



No.  
99519

1

- PL Grill węglowy
- GB Charcoal BBQ grill
- D Holzkohlegrill
- RUS Гриль-барбекю угольный
- CZ Gril na dřevěné uhlí
- RO Gratar carbuni
- H Faszén grill
- E Barbacoa de carbón y lena



No.  
99580

1

- PL Grill węglowy
- GB Charcoal BBQ grill
- D Holzkohlegrill
- RUS Гриль-барбекю угольный
- CZ Gril na dřevěné uhlí
- RO Gratar carbuni
- H Faszén grill
- E Barbacoa de carbón y lena



No.	99581	1
-----	-------	---

- PL Widelec ogniskowy
- GB Rake handle
- D Lagerfeuerspies
- RUS Шампур-вилка для гриля
- CZ Videlčka na opékání
- RO Furculita / tepusa
- H Grillvilla
- E Tenedor de fuego



No.	L (cm)	10/100
99568	98	

- PL Widelec ogniskowy
- GB Rake handle
- D Lagerfeuerspies
- RUS Шампур-вилка для гриля
- CZ Videlčka na opékání
- RO Furculita / tepusa
- H Grillvilla
- E Tenedor de fuego

No.	L (cm)	60
99576	120	

- PL Grill węglowy
- GB Charcoal BBQ grill
- D Holzkohlegrill
- RUS Гриль-барбекю угольный
- CZ Gril na dřevěné uhlí
- RO Gratar carbuni
- H Faszén grill
- E Barbacoa de carbón y lena

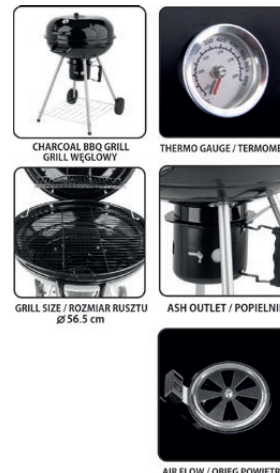

No.	99584	1
-----	-------	---

- PL Widelec ogniskowy
- GB Rake handle
- D Lagerfeuerspies
- RUS Шампур-вилка для гриля
- CZ Videlčka na opékání
- RO Furculita / tepusa
- H Grillvilla
- E Tenedor de fuego



No.	L (cm)	60
99575	120	

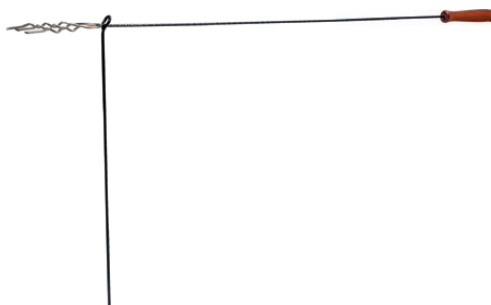

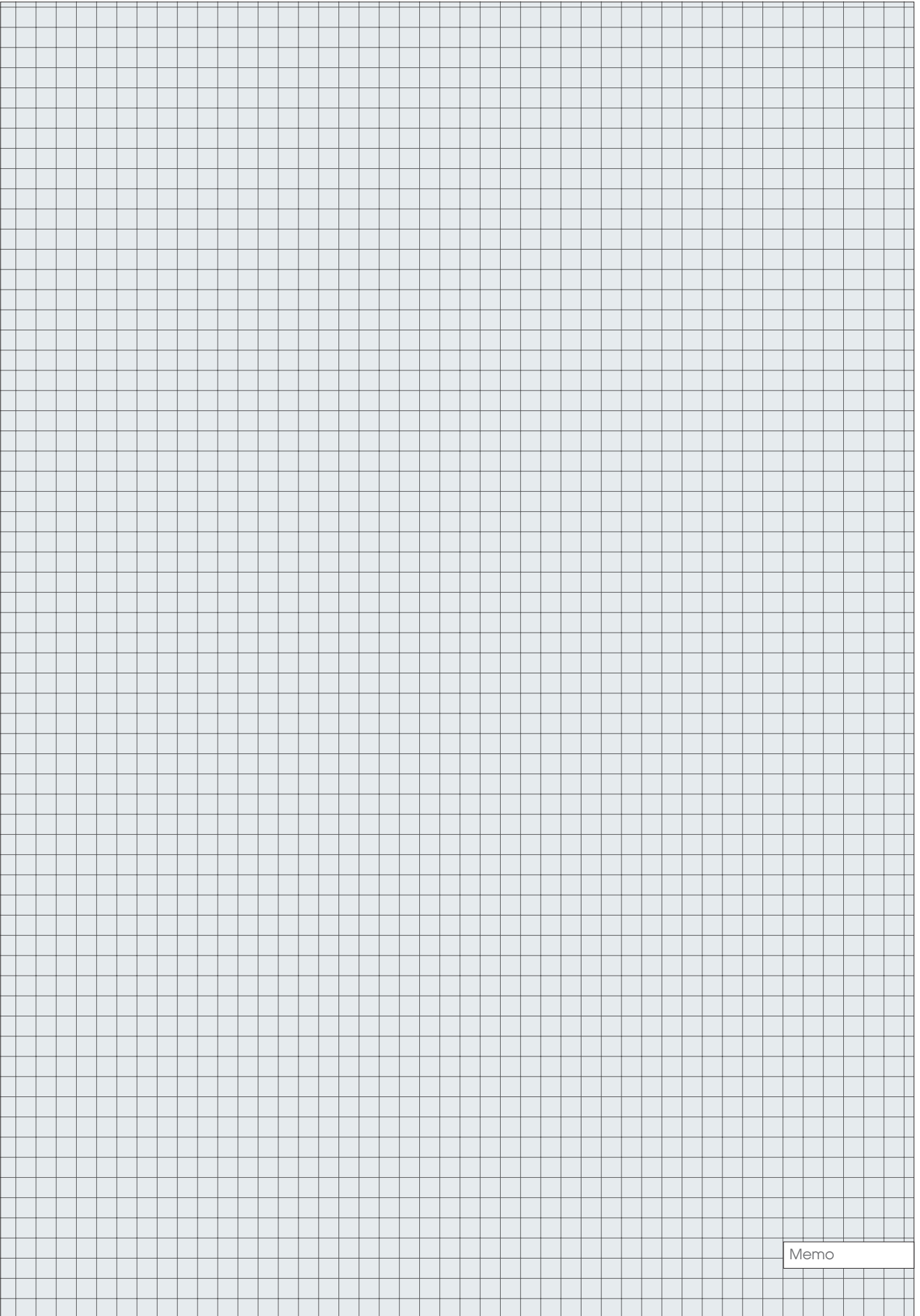

Memo

24

Sanitary ware & hydraulics  
Armatura sanitarna i hydraulika

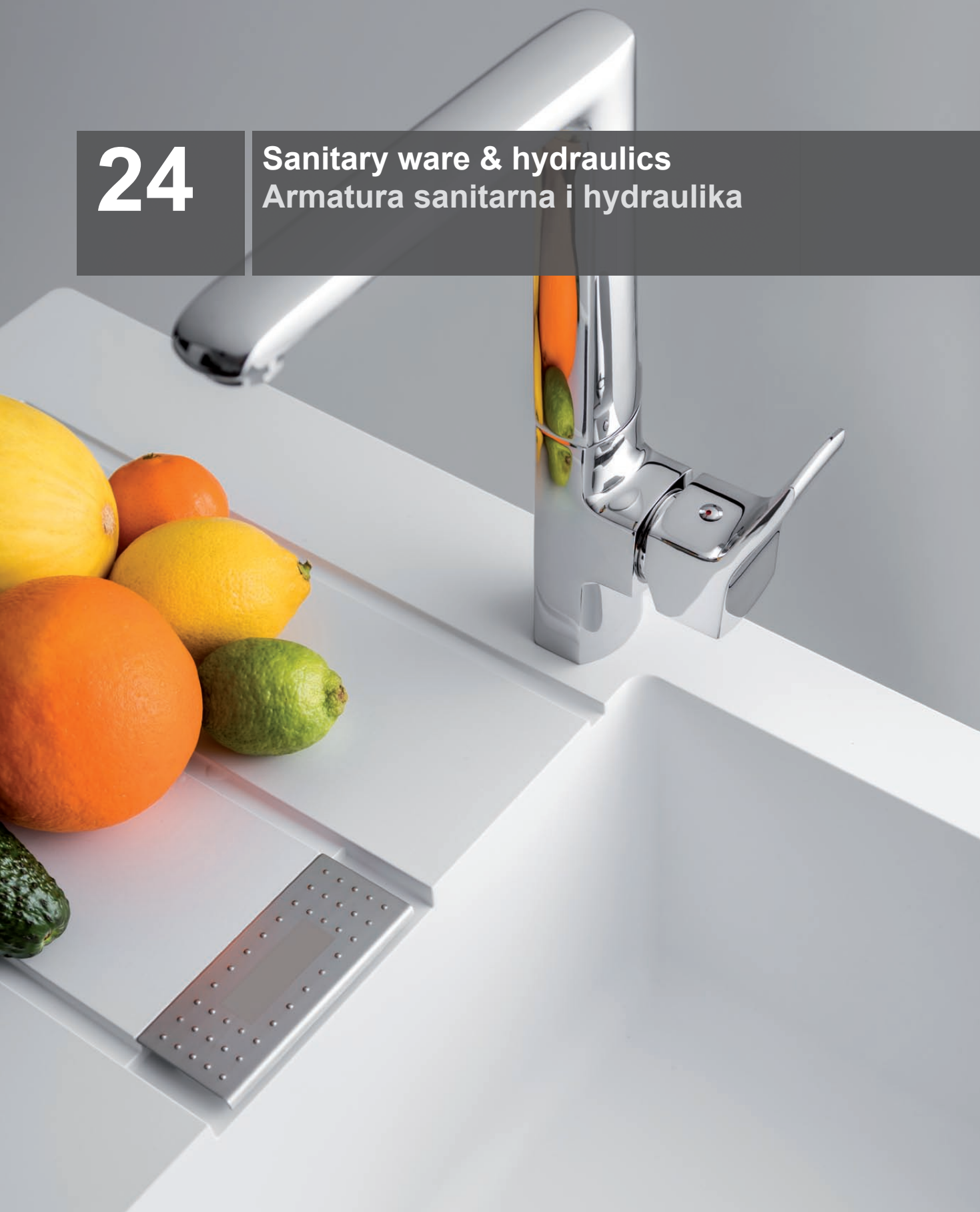



**Mixers, faucets**  
Baterie

.....384-388



**Linear drains**  
Odpływy liniowe

.....388-389



**Water regulators**  
Reduktory przepływu wody

.....389



**Pop-up wastes**  
Korki automatyczne

.....390



**Shower handles**  
Słuchawki prysznicowe

.....391-393



**Shower & connecting hoses**  
Wężę prysznicowe i przyłączeniowe

.....393-396



**Bathroom & shower sets**  
Komplety łazienkowe i prysznicowe

.....396-397



**Bathroom accessories**  
Akcesoria łazienkowe

.....397-398

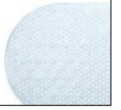

**Toilet seats**  
Deski toaletowe

.....399



**Plastic stools**  
Stołki plastikowe

.....399



**Hydraulic accessories**  
Akcesoria hydrauliczne

.....399-400



The exclusive composition with sapphire hardness developed by famous spanish company.

Głowica z wkładem ceramicznym o twardości szafiru renomowanego hiszpańskiego producenta.



**CORUNDOx**

Mixing water flow with intake air reduces consumption by half, without splashing.

Zmieszany strumień wody z zasysanym powietrzem oszczędza zużycie o połowę i nie chlapie.



**ECOflow**

The most effective way to save water and energy - flowing only cold water when the lever is centered.

Najefektywniejszy sposób oszczędzania wody i energii - dla uchwytu usytuowanego na wprost popłynie tylko zimna woda.



**ECOstart**

Nano-size cavities on the disc surface to keep the lubrication, provides a higher durability and an improved smooth feeling.

Mikrozagłębienia dzięki którym smar w głowicy nie wypłukuje się i głowica działa gładko przez wiele lat.



**NANOCave**

Rubbing the lime away with a finger and the stream is like in brand new faucet again.

Przetarcie palcem usuwa kamień i przywraca strumień jak w nowej baterii.



**SMARTclean**

Reduced noise thanks to silencer in eccentric wall connector.

Obniżony hałas dzięki użyciu tłumików w złączach.



**LOWnoise**

Ergonomic faucet provides more space for comfortable using.

Ergonomiczna bateria zapewniająca przestrzeń dla wygodnego użytkownika.



**ERGOsize**

Simple and effective installation thanks to the large nut that screw without any tools.

Łatwy i trwały montaż dzięki dużej nakrętce, którą przykręcisz bez użycia jakiegokolwiek narzędzi.



**SMARTnut**

Improved lime protection: integrated honeycomb structure replaces conventional wire mesh screens prone to lime build-up.

Lepsza ochrona przeciwkwapenna: struktura plastra miodu zastępuje klasyczne wkłady siateczkowe, które mają tendencję do zarastania.

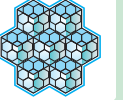

**HEXAGONal**

Body without holes and nooks that could accumulate dirt and microorganisms.

Korpus bez otworów i zakamarków, które gromadzą brud i mikroorganizmy.



**CLEANbody**

Innovative mounting system for hose nut and safe servicing aerator.

Innowacyjny system montażu wężyków i bezpiecznego serwisowania aeratora.



**SMARTtool**

Multi-purpose hydraulic wrench for installation of faucet and small plumbing work.

Wielofunkcyjny klucz hydrauliczny do montażu baterii i drobnych prac hydraulicznych.



**SMARTtool**

- PL Bateria umywalkowa
- GB Basin mixer
- D Einhand-Waschtischbatterie
- RUS Смеситель для раковины
- CZ Umyvadlová baterie
- RO Bateria lavoar
- H Mosdó csaptelep
- E Monomando de lavabo



**FALTA**

No.	type	box
75740	TARRAGONA	10

- PL Bateria prysznicowa
- GB Single-lever shower mixer
- D Einhand-Brausebatterie
- RUS Смеситель для раковины
- CZ Sprchová baterie
- RO Bateria dus
- H Egykaros zuhanycsaptelep
- E Monomando de ducha



**FALTA**

No.	type	box
75743	TARRAGONA	10

- PL Bateria wannowa
- GB Bath mixer
- D Einhand-Wannenbatterie
- RUS Смеситель для ванны
- CZ Vanové baterie
- RO Bateria cada/dus
- H Egykaros kádcsaptelep
- E Monomando para bañó

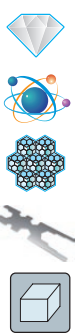

**FALTA**

No.	type	box
75742	TARRAGONA	8

- PL Bateria umywalkowa
- GB Basin mixer
- D Einhand-Waschtischbatterie
- RUS Смеситель для раковины
- CZ Umyvadlová baterie
- RO Bateria lavoar
- H Mosdó csaptelep
- E Monomando de lavabo

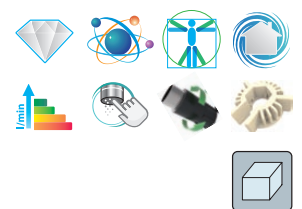

**FALTA**

No.	type	box
75770	ALICANTE	10

- PL Bateria wannowa
- GB Bath mixer
- D Einhand-Wannenbatterie
- RUS Смеситель для ванны
- CZ Vanové baterie
- RO Baterie cada / dus
- H Egykaros kádcsaptelep
- E Monomando para baño

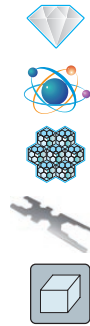

- PL Bateria prysznicowa
- GB Single-lever shower mixer
- D Einhand-Brausebatterie
- RUS Смеситель для душа
- CZ Sprchová baterie
- RO Baterie dus
- H Egykaros zuhanycsaptelep
- E Monomando de ducha



FALA

No.	type	
75772	ALICANTE	8

- PL Bateria zlewozmywakowa
- GB Single-lever sink mixer
- D Einhand-Spültischbatterie
- RUS Смеситель для кухни
- CZ Dřezová baterie
- RO Baterie stativă bucatărie
- H Mosogató csaptelep
- E Monomando de fregadero



FALA

No.	type	
75773	ALICANTE	10

- PL Bateria umywalkowa
- GB Basin mixer
- D Einhand-Waschtischbatterie
- RUS Смеситель для раковины
- CZ Umyvadlová baterie
- RO Baterie lavoar
- H Mosdó csaptelep
- E Monomando de lavabo



FALA

No.	type	
75774	ALICANTE	8

- PL Bateria wannowa
- GB Bath mixer
- D Einhand-Wannenbatterie
- RUS Смеситель для ванны
- CZ Vanové baterie
- RO Baterie cada / dus
- H Egykaros kádcsaptelep
- E Monomando para baño



FALA

No.	type	
75760	SORIA	10

- PL Bateria prysznicowa
- GB Single-lever shower mixer
- D Einhand-Brausebatterie
- RUS Смеситель для душа
- CZ Sprchová baterie
- RO Baterie dus
- H Egykaros zuhanycsaptelep
- E Monomando de ducha



FALA

No.	type	
75762	SORIA	8

- PL Bateria wannowa
- GB Bath mixer
- D Einhand-Wannenbatterie
- RUS Смеситель для ванны
- CZ Vanové baterie
- RO Baterie cada / dus
- H Egykaros kádcsaptelep
- E Monomando para baño

FALA

No.	type	
75763	SORIA	10

- PL Bateria prysznicowa
- GB Single-lever shower mixer
- D Einhand-Brausebatterie
- RUS Смеситель для душа
- CZ Sprchová baterie
- RO Baterie dus
- H Egykaros zuhanycsaptelep
- E Monomando de ducha

- PL Bateria zlewozmywakowa
- GB Single-lever sink mixer
- D Einhand-Spültischbatterie
- RUS Смеситель для кухни
- CZ Dřezová baterie
- RO Baterie stativă bucatărie
- H Mosogató csaptelep
- E Monomando de fregadero



**FALA**

No.	type	8
75764	SORIA	8

- PL Bateria wannowa
- GB Bath mixer
- D Einhand-Wannenbatterie
- RUS Смеситель для ванны
- CZ Vanové baterie
- RO Baterie cada / dus
- H Egykaros kádcsaptelep
- E Monomando para baño



**FALA**

No.	type	8
75767	MURCIA	8

- PL Bateria umywalkowa
- GB Basin mixer
- D Einhand-Waschtischbatterie
- RUS Смеситель для раковины
- CZ Umyvadlová baterie
- RO Baterie lavoar
- H Mosdó csaptelep
- E Monomando de lavabo



**FALA**

No.	type	10
75745	BURGOS	10

- PL Bateria umywalkowa
- GB Basin mixer
- D Einhand-Waschtischbatterie
- RUS Смеситель для раковины
- CZ Umyvadlová baterie
- RO Baterie lavoar
- H Mosdó csaptelep
- E Monomando de lavabo



**FALA**

No.	type	10
75765	MURCIA	10

- PL Bateria prysznicowa
- GB Single-lever shower mixer
- D Einhand-Brausebatterie
- RUS Смеситель для душа
- CZ Sprchová baterie
- RO Baterie dus
- H Egykaros zuhanycsaptelep
- E Monomando de ducha



**FALA**

No.	type	10
75768	MURCIA	10

- PL Bateria wannowa
- GB Bath mixer
- D Einhand-Wannenbatterie
- RUS Смеситель для ванны
- CZ Vanové baterie
- RO Baterie cada / dus
- H Egykaros kádcsaptelep
- E Monomando para baño



**FALA**

No.	type	8
75747	BURGOS	8

- PL Bateria prysznicowa
- GB Single-lever shower mixer
- D Einhand-Brausebatterie
- RUS Смеситель для душа
- CZ Sprchová baterie
- RO Bateria dus
- H Egykaros zuhanycsaptelep
- E Monomando de ducha



FALA

No.	type	
75748	BURGOS	10

- PL Bateria umywalkowa
- GB Basin mixer
- D Einhand-Waschtischbatterie
- RUS Смеситель для раковины
- CZ Umyvadlová baterie
- RO Bateria lavoar
- H Mosdó csaptelep
- E Monomando de lavabo



No.		
75685		12

- PL Bateria prysznicowa
- GB Single-lever shower mixer
- D Einhand-Brausebatterie
- RUS Смеситель для душа
- CZ Sprchová baterie
- RO Bateria dus
- H Egykaros zuhanycsaptelep
- E Monomando de ducha



No.		
75687		12

- PL Bateria zlewozmywakowa
- GB Single-lever sink mixer
- D Einhand-Spültischbatterie
- RUS Смеситель для кухни
- CZ Dřezová baterie
- RO Bateria staivă bucătărie
- H Mosogató csaptelep
- E Monomando de fregadero



FALA

No.	type	
75749	BURGOS	8

- PL Bateria wannowa
- GB Bath mixer
- D Einhand-Wannenbatterie
- RUS Смеситель для ванны
- CZ Vanové baterie
- RO Bateria cada / dus
- H Egykaros kádcsaptelep
- E Monomando para baño



No.		
75686		12

- PL Bateria umywalkowa ścienna
- GB Basin mixer
- D Einhand-Waschtischbatterie
- RUS Смеситель для раковины
- CZ Umyvadlová baterie
- RO Bateria lavoar
- H Mosdó csaptelep
- E Monomando de lavabo



No.		
75688		12

- PL Bateria zlewozmywakowa
- GB Single-lever sink mixer
- D Einhand-Spültischbatterie
- RUS Смеситель для кухни
- CZ Dřezová baterie
- RO Baterie stativă bucătărie
- H Mosogató csaptelep
- E Monomando de fregadero



No.	
75689	12

- PL Perlator i zestaw uszczelek do baterii
- GB Aerator and sealing set for sanitary mixers
- D Strahlregler- und dichtungsgummissatz für armatur
- RUS Аэратор с набором прокладок для смесителя
- CZ Perlátor a sada těsnění do baterie
- RO Sita și garnituri pt. baterii sanitare
- H Levegőztető és tömítőgumi készlet csaptelephez
- E Aireado y juego de juntas



FALA

No.	
75327	25/200

*Special inspection window for 100% outflow control and comfortable cleaning.*

**SMARTthru**

Specjalne okienko rewizyjne to 100% kontroli drożności i wygodne czyszczenie.

*Easy to clean thanks to contained hook.*

**EASYclean**

Łatwy do utrzymania w czystości dzięki dołączonemu haczykowi.

*Stabilizing body grips, additional stiffening in the floor.*

**GRIPstrong**

Uchwyty stabilizujące korpus. Dodatkowe usztywnienie konstrukcji w podłodze.

*Waterproof cloth included – as essential part of waterproofing.*

**HYDROcloth**

Mata uszczelniająca w zestawie – niezbędna część przy wykonywaniu hydroizolacji.

*Effective and durable strainer which prevents clogging of the trap and makes cleaning easier.*

**STRAINer**

Skuteczne i trwałe sito, które zapobiega zapychaniu syfonu oraz ułatwia bieżącą obsługę odpływu.

*High quality precision welds guarantee no leaking of the drain.*

**HQwelding**

Wysokiej jakości precyzyjne spawy gwarantujące szczelność odpływu.

*Low siphon made of stainless steel AISI 304 makes installation easier.*

**EXTRASlim**

Niski syfon wykonany ze stali nierdzewnej AISI 304 ułatwiający instalację.

*Wide range of height adjustment allows adjusting to the floor level.*

**EASYfix**

Szeroki zakres regulacji wysokości, który umożliwia dopasowanie odpływu do powierzchni posadzki.

- PL Odpływ liniowy
- GB Linear drain
- D Duschrinne
- RUS Душевой лоток
- CZ Odtokový žlab
- RO Rigola dus
- H Zuhanyfolyóka
- E Canal de ducha

**INOX**  
STAINLESS STEEL  
STÄHLNERZEUG

- PL Odpływ liniowy
- GB Linear drain
- D Duschrinne
- RUS Душевой лоток
- CZ Odtokový žlab
- RO Rigola dus
- H Zuhanyfolyóka
- E Canal de ducha

**INOX**  
STAINLESS STEEL  
STÄHLNERZEUG



FALA

No.	L (cm)	type	
75360	30	MADEIRA	6
75361	40	MADEIRA	6
75362	50	MADEIRA	6
75363	60	MADEIRA	6
75364	70	MADEIRA	6
75365	80	MADEIRA	6
75366	90	MADEIRA	6

FALA

No.	L (cm)	type	
75367	30	TOCANTINS	6
75368	40	TOCANTINS	6
75369	50	TOCANTINS	6
75370	60	TOCANTINS	6
75371	70	TOCANTINS	6
75372	80	TOCANTINS	6
75373	90	TOCANTINS	6

- PL Odpływ liniowy
- GB Linear drain
- D Duschrinne
- RUS Душевой лоток
- CZ Odtokový žlab
- RO Rigola dus
- H Zuhanyfolyóka
- E Canal de ducha



No.	L (cm)	type	
75374	30	NAPO	6
75375	40	NAPO	6
75376	50	NAPO	6
75377	60	NAPO	6
75378	70	NAPO	6
75379	80	NAPO	6
75380	90	NAPO	6



- PL Reduktor przepływu wody
- GB Water flow rate reducer
- D Wassersparer
- RUS Регулятор расхода воды
- CZ Regulátor toku vody
- RO Reductor de debit de apă
- H Áramlás korlátozó
- E Regulador de flujo de agua

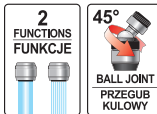

- PL Reduktor przepływu wody
- GB Water flow rate reducer
- D Wassersparer
- RUS Регулятор расхода воды
- CZ Regulátor toku vody
- RO Reductor de debit de apă
- H Áramlás korlátozó
- E Regulador de flujo de agua



No.	
75328	20/120



No.	
75329	10/60

- PL Reduktor przepływu wody
- GB Water flow rate reducer
- D Wassersparer
- RUS Регулятор расхода воды
- CZ Regulátor toku vody
- RO Reductor de debit de apă
- H Áramlás korlátozó
- E Regulador de flujo de agua



- PL Reduktor przepływu wody
- GB Water flow rate reducer
- D Wassersparer
- RUS Регулятор расхода воды
- CZ Regulátor toku vody
- RO Reductor de debit de apă
- H Áramlás korlátozó
- E Regulador de flujo de agua



No.	
75330	10/60



No.	
75331	10/60

- PL Reduktor przepływu wody
- GB Water flow rate reducer
- D Wassersparer
- RUS Регулятор расхода воды
- CZ Regulátor toku vody
- RO Reductor de debit de apă
- H Áramlás korlátozó
- E Regulador de flujo de agua



- PL Reduktor przepływu wody
- GB Water flow rate reducer
- D Wassersparer
- RUS Регулятор расхода воды
- CZ Regulátor toku vody
- RO Reductor de debit de apă
- H Áramlás korlátozó
- E Regulador de flujo de agua



No.	
75332	20/120



No.	
75333	10/60

- PL Korek do umywalki
- GB Pop-up waste
- D Waschbecken stöpsel
- RUS Автоматическая пробка
- CZ Automatická zátka
- RO Sifon chiuveta
- H Mosdo lefolyo elzaro
- E Tapón automat. para bateria de lado



**FALA**

No.	12/48
75498	

- PL Korek automatyczny
- GB Pop-up waste
- D Waschbecken stöpsel
- RUS Автоматическая пробка для умывальника
- CZ Automatická zátka
- RO Sifon chiuveta
- H Mosdo lefolyo elzaro
- E Tapón automat. para bateria de lado

CLICK - CLACK

EASY TO CLEAN  
UNDO A PLUG POSSIBILITY

LATWE CZYSZCZENIE  
MOŻLIWOŚĆ  
ODKREŚCENIA KORKA

G 1 1/4

UNIVERSAL THREAD  
UNIWERSALNY  
GWINT

FOR WASH BASIN  
WITH OVERFLOW  
DO UMYWALEK  
Z PRZELEWEM

CHROME  
PLATED  
CHROMOWANY



**FALA**

No.	48/96
75483	

- PL Korek automatyczny
- GB Pop-up waste
- D Waschbecken stöpsel
- RUS Автоматическая пробка для умывальника
- CZ Automatická zátka
- RO Sifon chiuveta
- H Mosdo lefolyo elzaro
- E Tapón automat. para bateria de lado

CLICK - CLACK

EASY TO CLEAN  
UNDO A PLUG POSSIBILITY

LATWE CZYSZCZENIE  
MOŻLIWOŚĆ  
ODKREŚCENIA KORKA

G 1 1/4

UNIVERSAL THREAD  
UNIWERSALNY  
GWINT

FOR WASH BASIN  
WITH OVERFLOW  
DO UMYWALEK  
BEZ PRZELEWU

BRASS  
MOSIĄDZ

BRUSHED  
NICKEL  
SZCZYTLOWANY



**FALA**

No.	20/40
75485	

- PL Korek automatyczny
- GB Pop-up waste
- D Waschbecken stöpsel
- RUS Автоматическая пробка для умывальника
- CZ Automatická zátka
- RO Sifon chiuveta
- H Mosdo lefolyo elzaro
- E Tapón automat. para bateria de lado

CLICK - CLACK

EASY TO CLEAN  
UNDO A PLUG POSSIBILITY

LATWE CZYSZCZENIE  
MOŻLIWOŚĆ  
ODKREŚCENIA KORKA

G 1 1/4

UNIVERSAL THREAD  
UNIWERSALNY  
GWINT

FOR WASH BASIN  
WITH OVERFLOW  
DO UMYWALEK  
Z PRZELEWEM

BRASS  
MOSIĄDZ

CHROME  
PLATED  
CHROMOWANY



**FALA**

No.	20/40
75487	

- PL Korek do umywalki
- GB Pop-up waste
- D Waschbecken stöpsel
- RUS Автоматическая пробка
- CZ Automatická zátka
- RO Sifon chiuveta
- H Mosdo lefolyo elzaro
- E Tapón automat. para bateria de lado



**FALA**

No.	12/48
75499	

- PL Korek automatyczny
- GB Pop-up waste
- D Waschbecken stöpsel
- RUS Автоматическая пробка для умывальника
- CZ Automatická zátka
- RO Sifon chiuveta
- H Mosdo lefolyo elzaro
- E Tapón automat. para bateria de lado

CLICK - CLACK

EASY TO CLEAN  
UNDO A PLUG POSSIBILITY

LATWE CZYSZCZENIE  
MOŻLIWOŚĆ  
ODKREŚCENIA KORKA

G 1 1/4

UNIVERSAL THREAD  
UNIWERSALNY  
GWINT

FOR WASH BASIN  
WITH OVERFLOW  
DO UMYWALEK  
Z PRZELEWEM

BRASS  
MOSIĄDZ

CHROME  
PLATED  
CHROMOWANY



**FALA**

No.	20/40
75484	

- PL Korek automatyczny
- GB Pop-up waste
- D Waschbecken stöpsel
- RUS Автоматическая пробка для умывальника
- CZ Automatická zátka
- RO Sifon chiuveta
- H Mosdo lefolyo elzaro
- E Tapón automat. para bateria de lado

CLICK - CLACK

EASY TO CLEAN  
UNDO A PLUG POSSIBILITY

LATWE CZYSZCZENIE  
MOŻLIWOŚĆ  
ODKREŚCENIA KORKA

G 1 1/4

UNIVERSAL THREAD  
UNIWERSALNY  
GWINT

FOR WASH BASIN  
WITH OVERFLOW  
DO UMYWALEK  
BEZ PRZELEWU

BRASS  
MOSIĄDZ

CHROME  
PLATED  
CHROMOWANY



**FALA**

No.	20/40
75486	

- PL Korek automatyczny
- GB Pop-up waste
- D Waschbecken stöpsel
- RUS Автоматическая пробка для умывальника
- CZ Automatická zátka
- RO Sifon chiuveta
- H Mosdo lefolyo elzaro
- E Tapón automat. para bateria de lado

CLICK - CLACK

EASY TO CLEAN  
UNDO A PLUG POSSIBILITY

LATWE CZYSZCZENIE  
MOŻLIWOŚĆ  
ODKREŚCENIA KORKA

G 1 1/4

UNIVERSAL THREAD  
UNIWERSALNY  
GWINT

FOR WASH BASIN  
WITH OVERFLOW  
DO UMYWALEK  
Z PRZELEWEM

BRASS  
MOSIĄDZ

BRUSHED  
NICKEL  
SZCZYTLOWANY



**FALA**

No.	20/40
75488	



PL Sluchawka prysznicowa  
 GB Shower handle  
 D Handbrause  
 RUS Разбрызгиватель для душа  
 CZ Ruční sprcha  
 RO Cap duș  
 H Kézi zuhanyfej  
 E Ducha

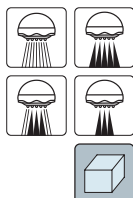

**FALA**

No.  
75540

20/80

PL Sluchawka prysznicowa  
 GB Shower handle  
 D Handbrause  
 RUS Разбрызгиватель для душа  
 CZ Ruční sprcha  
 RO Cap duș  
 H Kézi zuhanyfej  
 E Ducha

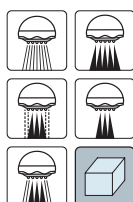

**FALA**

No.  
75543

12/48

PL Sluchawka prysznicowa  
 GB Shower handle  
 D Handbrause  
 RUS Разбрызгиватель для душа  
 CZ Ruční sprcha  
 RO Cap duș  
 H Kézi zuhanyfej  
 E Ducha



**FALA**

No.  
75544

15/60

PL Sluchawka prysznicowa  
 GB Shower handle  
 D Handbrause  
 RUS Разбрызгиватель для душа  
 CZ Ruční sprcha  
 RO Cap duș  
 H Kézi zuhanyfej  
 E Ducha



**FALA**

No.  
75550

30/60

PL Sluchawka prysznicowa  
 GB Shower handle  
 D Handbrause  
 RUS Разбрызгиватель для душа  
 CZ Ruční sprcha  
 RO Cap duș  
 H Kézi zuhanyfej  
 E Ducha

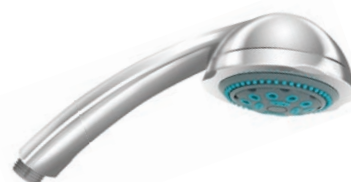

**FALA**

No.  
75541

20/80

PL Sluchawka prysznicowa  
 GB Shower handle  
 D Handbrause  
 RUS Разбрызгиватель для душа  
 CZ Ruční sprcha  
 RO Cap duș  
 H Kézi zuhanyfej  
 E Ducha

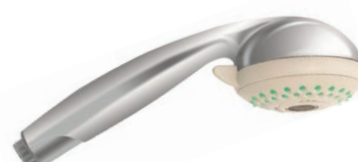
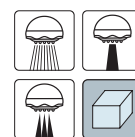

**FALA**

No.  
75545

15/60

PL Sluchawka prysznicowa  
 GB Shower handle  
 D Handbrause  
 RUS Разбрызгиватель для душа  
 CZ Ruční sprcha  
 RO Cap duș  
 H Kézi zuhanyfej  
 E Ducha



**FALA**

No.  
75548

30/60

PL Sluchawka prysznicowa  
 GB Shower handle  
 D Handbrause  
 RUS Разбрызгиватель для душа  
 CZ Ruční sprcha  
 RO Cap duș  
 H Kézi zuhanyfej  
 E Ducha

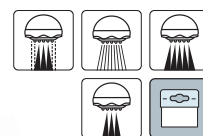

**FALA**

No.  
75551

30/60

- PL Słuchawka prysznicowa
- GB Shower handle
- D Handbrause
- RUS Разбрызгиватель для душа
- CZ Ruční sprcha
- RO Cap duș
- H Kézi zuhanyfej
- E Ducha



**FALA**

No.		
75552		30/60

- PL Słuchawka prysznicowa
- GB Shower handle
- D Handbrause
- RUS Разбрызгиватель для душа
- CZ Ruční sprcha
- RO Cap duș
- H Kézi zuhanyfej
- E Ducha



**FALA**

No.		
75562		50

- PL Słuchawka prysznicowa
- GB Shower handle
- D Handbrause
- RUS Разбрызгиватель для душа
- CZ Ruční sprcha
- RO Cap duș
- H Kézi zuhanyfej
- E Ducha

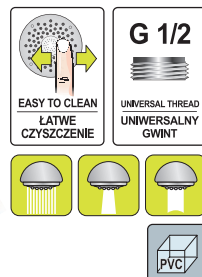

**FALA**

No.	type	
75627	DELTA	24/48

- PL Słuchawka prysznicowa
- GB Shower handle
- D Handbrause
- RUS Разбрызгиватель для душа
- CZ Ruční sprcha
- RO Cap duș
- H Kézi zuhanyfej
- E Ducha



**FALA**

No.	type	
75629	TUGELA	24/48

- PL Słuchawka prysznicowa
- GB Shower handle
- D Handbrause
- RUS Разбрызгиватель для душа
- CZ Ruční sprcha
- RO Cap duș
- H Kézi zuhanyfej
- E Ducha

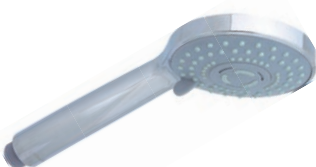
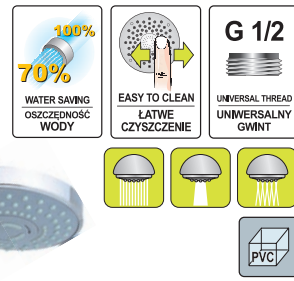

**FALA**

No.	type	
75631	HERMANA	25/50

- PL Słuchawka prysznicowa
- GB Shower handle
- D Handbrause
- RUS Разбрызгиватель для душа
- CZ Ruční sprcha
- RO Cap duș
- H Kézi zuhanyfej
- E Ducha

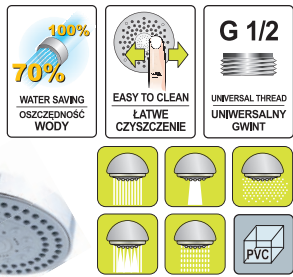

**FALA**

No.	type	
75626	KILE	25/50

- PL Słuchawka prysznicowa
- GB Shower handle
- D Handbrause
- RUS Разбрызгиватель для душа
- CZ Ruční sprcha
- RO Cap duș
- H Kézi zuhanyfej
- E Ducha

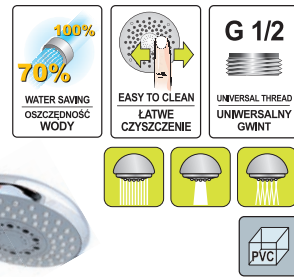

**FALA**

No.	type	
75625	DETIFOS	25/50

**FALA**

No.	type	
75624	SALTO	25/50

- PL Słuchawka prysznicowa  
 GB Shower handle  
 D Handbrause  
 RUS Разбрызгиватель для душа  
 CZ Ruční sprcha  
 RO Cap duș  
 H Kézi zuhanyfej  
 E Ducha

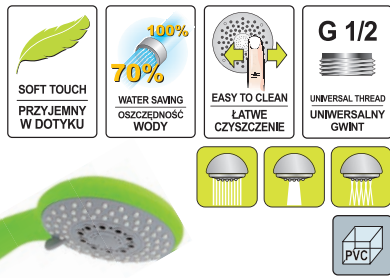

FALA

No.	type	
75620	SALTO	25/50

- PL Słuchawka prysznicowa  
 GB Shower handle  
 D Handbrause  
 RUS Разбрызгиватель для душа  
 CZ Ruční sprcha  
 RO Cap duș  
 H Kézi zuhanyfej  
 E Ducha



FALA

No.	type	
75622	SALTO	25/50

- PL Uchwyt do słuchawki prysznicowej  
 GB Shower holder  
 D Brauseporter  
 RUS Держатель душ  
 CZ Držák s klobom na sprchu  
 RO Suport pt. dus  
 H Zuhanycső tartó  
 E Grifo para ducha



FALA

No.		
75564		50/200

- PL Wąż prysznicowy  
 GB Shower hose  
 D Brausenschlauch  
 RUS Шланг для душа
- CZ Sprchová hadice  
 RO Furtun duș  
 H Zuhanycső  
 E Manguera de ducha

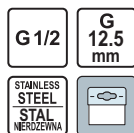

FALA

No.	L (m)	
75553	1.5	30/60
75554	1.7	30/60

- PL Słuchawka prysznicowa  
 GB Shower handle  
 D Handbrause  
 RUS Разбрызгиватель для душа  
 CZ Ruční sprcha  
 RO Cap duș  
 H Kézi zuhanyfej  
 E Ducha

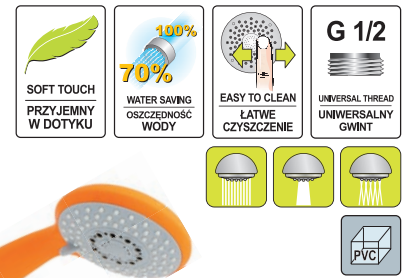

FALA

No.	type	
75621	SALTO	25/50

- PL Słuchawka prysznicowa  
 GB Shower handle  
 D Handbrause  
 RUS Разбрызгиватель для душа  
 CZ Ruční sprcha  
 RO Cap duș  
 H Kézi zuhanyfej  
 E Ducha



FALA

No.	type	
75623	SALTO	25/50

- PL Uchwyt do słuchawki prysznicowej  
 GB Shower holder  
 D Brauseporter  
 RUS Держатель душ  
 CZ Držák s klobom na sprchu  
 RO Suport pt. dus  
 H Zuhanycső tartó  
 E Grifo para ducha



FALA

No.		
75565		30/180

- PL Wąż prysznicowy  
 GB Shower hose  
 D Brausenschlauch  
 RUS Шланг для душа
- CZ Sprchová hadice  
 RO Furtun duș  
 H Zuhanycső  
 E Manguera de ducha



FALA

No.	L (m)	
75574	1.5-2.0	24

PL Wąż prysznicowy  
GB Shower hose  
D Brausenschlauch  
RUS Шланг для душа

CZ Sprchová hadice  
RO Furtun duș  
H Zuhanycső  
E Manguera de ducha

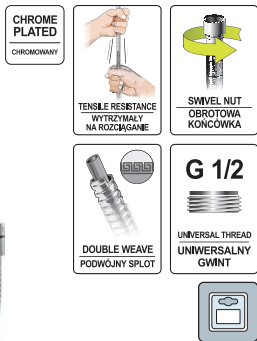

**FALA**

No.	L (m)	
75572	1.5	24
75573	2.0	24

PL Wąż prysznicowy  
GB Shower hose  
D Brausenschlauch  
RUS Шланг для душа

CZ Sprchová hadice  
RO Furtun duș  
H Zuhanycső  
E Manguera de ducha

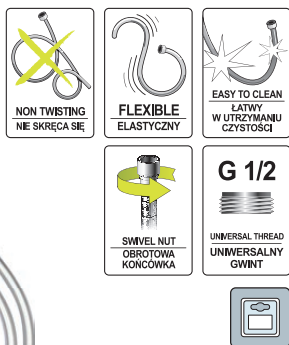

**FALA**

No.	L (m)	
75596	1.5	24
75597	2.0	24

PL Wąż prysznicowy  
GB Shower hose  
D Brausenschlauch  
RUS Шланг для душа

CZ Sprchová hadice  
RO Furtun duș  
H Zuhanycső  
E Manguera de ducha

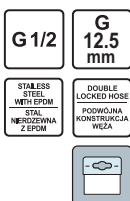

**FALA**

No.	L (m)	
75578	1.5	30/60
75579	1.7	30/60

PL Wąż prysznicowy  
GB Shower hose  
D Brausenschlauch  
RUS Шланг для душа

CZ Sprchová hadice  
RO Furtun duș  
H Zuhanycső  
E Manguera de ducha

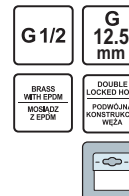

**FALA**

No.	L (m)	
75570	1.5	30/60

PL Wąż prysznicowy  
GB Shower hose  
D Brausenschlauch  
RUS Шланг для душа

CZ Sprchová hadice  
RO Furtun duș  
H Zuhanycső  
E Manguera de ducha



**FALA**

No.	L (m)	
75571	1.7	25/50

PL Wąż prysznicowy  
GB Shower hose  
D Brausenschlauch  
RUS Шланг для душа

CZ Sprchová hadice  
RO Furtun duș  
H Zuhanycső  
E Manguera de ducha



**FALA**

No.	L (m)	
75598	1.5	24
75599	2.0	24

PL Wąż prysznicowy  
GB Shower hose  
D Brausenschlauch  
RUS Шланг для душа

CZ Sprchová hadice  
RO Furtun duș  
H Zuhanycső  
E Manguera de ducha



**FALA**

No.	L (m)	
75594	1.5	24
75595	2.0	24

- PL Wąż przyłączeniowy elastyczny  
 GB Flexible connecting hose  
 D Edelstahl flexschlauch  
 RUS Гибкий шланг для смесителя  
 CZ Flexibilní nerezové hadice na vodu  
 RO Racorduri flexibile pt. apa  
 H Rugalmas rozsdamentes acél cső a víz  
 E Manguera flexible de acero inoxidable para el agua

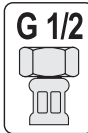
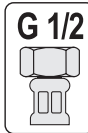
1 MPa  
max90°C  
max

No.	L (mm)	
71800	300	180
71801	400	150
71802	500	120
71803	600	120
71804	800	100
71805	1000	80

- PL Wąż przyłączeniowy elastyczny  
 GB Flexible connecting hose  
 D Edelstahl flexschlauch  
 RUS Гибкий шланг для смесителя  
 CZ Flexibilní nerezové hadice na vodu  
 RO Racorduri flexibile pt. apa  
 H Rugalmas rozsdamentes acél cső a víz  
 E Manguera flexible de acero inoxidable para el agua

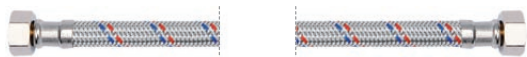
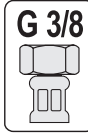
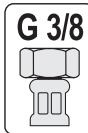
1 MPa  
max90°C  
max

No.	L (mm)	
71814	300	250
71815	400	200
71816	500	150
71817	600	120
71818	800	100
71819	1000	80

- PL Wąż przyłączeniowy elastyczny  
 GB Flexible connecting hose  
 D Edelstahl flexschlauch  
 RUS Гибкий шланг для смесителя  
 CZ Flexibilní nerezové hadice na vodu  
 RO Racorduri flexibile pt. apa  
 H Rugalmas rozsdamentes acél cső a víz  
 E Manguera flexible de acero inoxidable para el agua

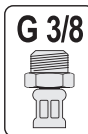
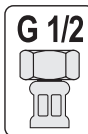
1 MPa  
max90°C  
max

No.	L (mm)	
71827	300	10/300
71828	400	10/250
71829	500	10/200
71830	600	10/150
71831	800	10/100
71832	1000	10/80

- PL Wąż przyłączeniowy elastyczny  
 GB Flexible connecting hose  
 D Edelstahl flexschlauch  
 RUS Гибкий шланг для смесителя  
 CZ Flexibilní nerezové hadice na vodu  
 RO Racorduri flexibile pt. apa  
 H Rugalmas rozsdamentes acél cső a víz  
 E Manguera flexible de acero inoxidable para el agua

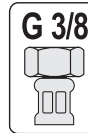
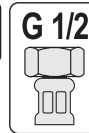
1 MPa  
max90°C  
max

No.	L (mm)	
71807	300	200
71808	400	150
71809	500	120
71810	600	100
71811	800	10/100
71812	1000	10/80

- PL Wąż przyłączeniowy elastyczny  
 GB Flexible connecting hose  
 D Edelstahl flexschlauch  
 RUS Гибкий шланг для смесителя  
 CZ Flexibilní nerezové hadice na vodu  
 RO Racorduri flexibile pt. apa  
 H Rugalmas rozsdamentes acél cső a víz  
 E Manguera flexible de acero inoxidable para el agua

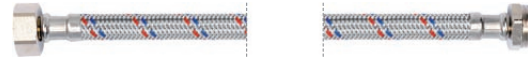
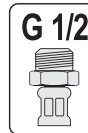
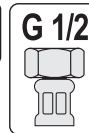
1 MPa  
max90°C  
max

No.	L (mm)	
71820	300	10/250
71821	400	10/200
71822	500	10/160
71823	600	10/150
71824	800	10/100
71825	1000	10/80

- PL Wąż przyłączeniowy elastyczny  
 GB Flexible connecting hose  
 D Edelstahl flexschlauch  
 RUS Гибкий шланг для смесителя  
 CZ Flexibilní nerezové hadice na vodu  
 RO Racorduri flexibile pt. apa  
 H Rugalmas rozsdamentes acél cső a víz  
 E Manguera flexible de acero inoxidable para el agua

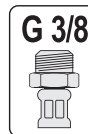
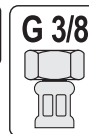
1 MPa  
max90°C  
max

No.	L (mm)	
71833	300	250
71834	400	200
71835	500	10/200
71836	600	120
71837	800	10/100
71838	1000	80

- PL Wąż przyłączeniowy elastyczny  
 GB Flexible connecting hose  
 D Edelstahl flexschlauch  
 RUS Гибкий шланг для смесителя  
 CZ Flexibilní nerezové hadice na vodu  
 RO Racorduri flexibile pt. apa  
 H Rugalmas rozsdamentes acél cső a víz  
 E Manguera flexible de acero inoxidable para el agua

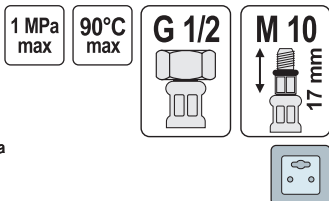

FALA

No.	L (mm)	☐
71840	300	10/300
71841	400	200
71842	500	10/200
71843	600	120
71844	800	10/100

- PL Wąż przyłączeniowy elastyczny  
 GB Flexible connecting hose  
 D Edelstahl flexschlauch  
 RUS Гибкий шланг для смесителя  
 CZ Flexibilní nerezové hadice na vodu  
 RO Racorduri flexibile pt. apa  
 H Rugalmas rozsdamentes acél cső a víz  
 E Manguera flexible de acero inoxidable para el agua

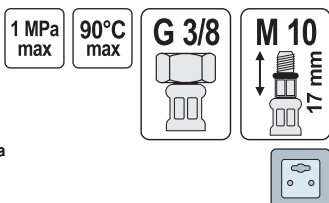

FALA

No.	L (mm)	☐
71851	300	10/300
71852	400	150
71853	500	150
71854	600	120
71855	800	10/100

- PL Zestaw łazienkowy  
 GB Bathroom set  
 D Brausegarnitur  
 RUS Набор для душевой  
 CZ Sprchová souprava  
 RO Set pt. dus  
 H Zuhanyszó készlet  
 E Juego de baño ducha



FALA

No.	☐
75555	12

- PL Wąż przyłączeniowy elastyczny  
 GB Flexible connecting hose  
 D Edelstahl flexschlauch  
 RUS Гибкий шланг для смесителя  
 CZ Flexibilní nerezové hadice na vodu  
 RO Racorduri flexibile pt. apa  
 H Rugalmas rozsdamentes acél cső a víz  
 E Manguera flexible de acero inoxidable para el agua

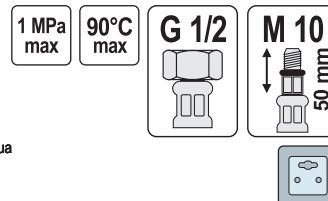

FALA

No.	L (mm)	☐
71846	300	10/300
71847	400	200
71848	500	150
71849	600	120
71850	800	100

- PL Wąż przyłączeniowy elastyczny  
 GB Flexible connecting hose  
 D Edelstahl flexschlauch  
 RUS Гибкий шланг для смесителя  
 CZ Flexibilní nerezové hadice na vodu  
 RO Racorduri flexibile pt. apa  
 H Rugalmas rozsdamentes acél cső a víz  
 E Manguera flexible de acero inoxidable para el agua

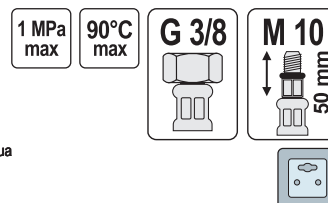

FALA

No.	L (mm)	☐
71856	300	200
71857	400	150
71858	500	150
71859	600	120
71860	800	100

- PL Zestaw łazienkowy  
 GB Bathroom set  
 D Brausegarnitur  
 RUS Набор для душевой  
 CZ Sprchová souprava  
 RO Set pt. dus  
 H Zuhanyszó készlet  
 E Juego de baño ducha

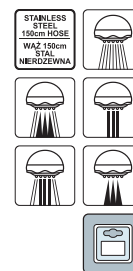

FALA

No.	☐
75556	12

- PL Zestaw łazienkowy
- GB Bathroom set
- D Brausegarnitur
- RUS Набор для душевой
- CZ Sprchová souprava
- RO Set pt. dus
- H Zuhanyzó készlet
- E Juego de baño ducha



- PL Zestaw łazienkowy
- GB Bathroom set
- D Brausegarnitur
- RUS Набор для душевой
- CZ Konzole na sprchu
- RO Suport dus
- H Zuhanytartó rúd
- E Carril de ducha



FALA

No.  
75558

12

FALA

No.  
75559

16

- PL Zestaw łazienkowy
- GB Bathroom set
- D Brausegarnitur
- RUS Набор для душевой
- CZ Sprchová souprava
- RO Set pt. dus
- H Zuhanyzó készlet
- E Juego de baño ducha



- PL Zestaw łazienkowy
- GB Bathroom set
- D Brausegarnitur
- RUS Набор для душевой
- CZ Sprchová souprava
- RO Set pt. dus
- H Zuhanyzó készlet
- E Juego de baño ducha



FALA

No.  
75660

5

FALA

No.  
75661

5

- PL Mata antypoślizgowa
- GB Anti-slip mat
- D Anti-rutsch-matte
- RUS Противоскользящий коврик
- CZ Protiskluzová podložka
- RO Mat anti-alunecare
- H Csúszásgátló lábtörő
- E Alfombra antideslizante

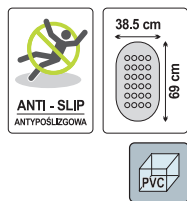

FALA

No.  
75910

size / rozmiar (cm)  
69x38.5

24

- PL Mata antypoślizgowa
- GB Anti-slip mat
- D Anti-rutsch-matte
- RUS Противоскользящий коврик
- CZ Protiskluzová podložka
- RO Mat anti-alunecare
- H Csúszásgátló lábtörő
- E Alfombra antideslizante

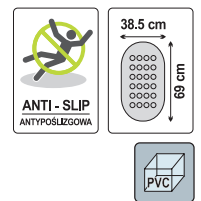

FALA

No.  
75911

size / rozmiar (cm)  
69x38.5

24

- PL Mata antypoślizgowa
- GB Anti-slip mat
- D Anti-rutsch-matte
- RUS Противоскользящий коврик
- CZ Protiskuzová podložka
- RO Mat anti-alunecare
- H Csúszásgátló lábtörő
- E Alfombra antideslizante

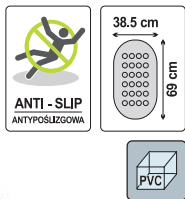

**FALA**

No.	size / rozmiar (cm)	
75912	69x38.5	24

- PL Zaslونka prysznicowa
- GB Shower curtain
- D Duschvorhang
- RUS Занавеска для душа
- CZ Sprchový závěs
- RO Perdea duș
- H Zuhanyfüggöny
- E Cortina de ducha

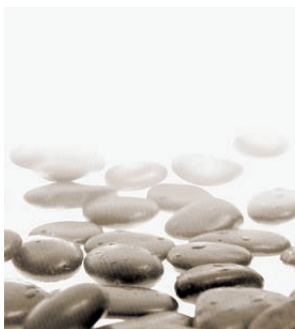
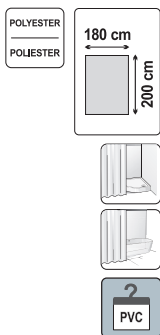

**FALA**

No.	size / rozmiar (cm)	
75970	180x200	24

- PL Zaslونka prysznicowa
- GB Shower curtain
- D Duschvorhang
- RUS Занавеска для душа
- CZ Sprchový závěs
- RO Perdea duș
- H Zuhanyfüggöny
- E Cortina de ducha

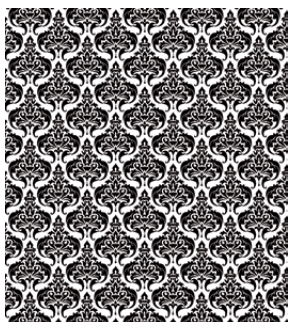
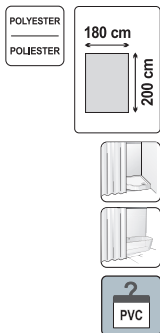

**FALA**

No.	size / rozmiar (cm)	
75972	180x200	24

- PL Zaslونka prysznicowa
- GB Shower curtain
- D Duschvorhang
- RUS Занавеска для душа
- CZ Sprchový závěs
- RO Perdea duș
- H Zuhanyfüggöny
- E Cortina de ducha

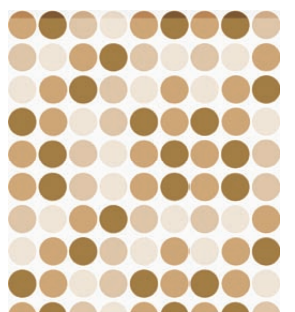
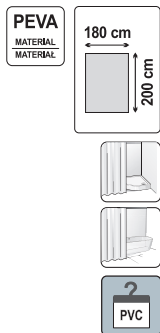

**FALA**

No.	size / rozmiar (cm)	
75974	180x200	24



- PL Mata antypoślizgowa
- GB Anti-slip mat
- D Anti-rutsch-matte
- RUS Противоскользящий коврик
- CZ Protiskuzová podložka
- RO Mat anti-alunecare
- H Csúszásgátló lábtörő
- E Alfombra antideslizante

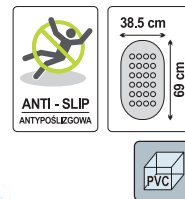

**FALA**

No.	size / rozmiar (cm)	
75914	69x38.5	24

- PL Zaslонka prysznicowa
- GB Shower curtain
- D Duschvorhang
- RUS Занавеска для душа
- CZ Sprchový závěs
- RO Perdea duș
- H Zuhanyfüggöny
- E Cortina de ducha



**FALA**

No.	size / rozmiar (cm)	
75971	180x200	24

- PL Zaslонka prysznicowa
- GB Shower curtain
- D Duschvorhang
- RUS Занавеска для душа
- CZ Sprchový závěs
- RO Perdea duș
- H Zuhanyfüggöny
- E Cortina de ducha

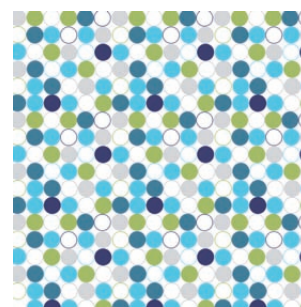

**FALA**

No.	size / rozmiar (cm)	
75973	180x200	24

- PL Drajek prysznicowy
- GB Curtain rod
- D Gardinenstange
- RUS Карниз для штор в ванну
- CZ Závěs tyč
- RO Cortina tijă
- H Fűggönyrúd
- E Barra para cortina de ducha

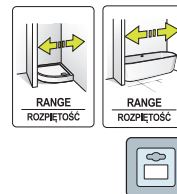

**FALA**

No.	range / rozpiętość (cm)	
75992	90-160	24
75993	110-200	24



- PL Deska sedesowa
- GB Toilet seat
- D WC Deckel
- RUS Сиденье для унитаза
- CZ WC sedátko
- RO Capac WC
- H WC-ülőke
- E Asiento de inodoro

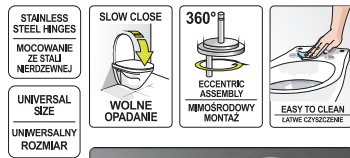

SLOW CLOSE / WOLNE OPADANIE



FALA

No.	size / rozmiar (cm)	cube
75470		6

- PL Pompa sanitarna z rozdrabniaczem
- GB Sewage lifting station with grinder
- D Kleinhebeanlage fäkalienhaltiges Abwasser
- RUS Канализационная насосная установка
- CZ Sanitární kalové čerpadlo
- RO Stația pt. evacuarea apelor uzate
- H Átemelő szivattyú
- E Estación de levantamiento para aguas residuales

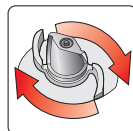

CUTTING SYSTEM / SYSTEM TNĄCY

230V~50Hz 600 W

3000 min<sup>-1</sup> Q max 270 l/min

90°C max 7m ↑

4 BLADES / OSTRZA 2x Ø100 mm 2x Ø40 mm



No.	W	cube
75950	600	1

- PL Stolek plastikowy
- GB Plastic stool
- D Kunststoff Hocker
- RUS Пластиковый табурет
- CZ Plastová stolička
- RO Scaun de plastic
- H Müanyag széklét
- E Taburete de plástico



ANTI - SLIP / ANTYPOŚLIŹGOWY



FALA

No.	size / rozmiar (cm)	cube
75915	30x20x21	10/20

- PL Stolek plastikowy
- GB Plastic stool
- D Kunststoff Hocker
- RUS Пластиковый табурет
- CZ Plastová stolička
- RO Scaun de plastic
- H Müanyag széklét
- E Taburete de plástico



ANTI - SLIP / ANTYPOŚLIŹGOWY



FALA

No.	size / rozmiar (cm)	cube
75916	30x20x21	10/20

- PL Pompa sanitarna z rozdrabniaczem
- GB Sewage lifting station with grinder
- D Kleinhebeanlage fäkalienhaltiges Abwasser
- RUS Канализационная насосная установка
- CZ Sanitární kalové čerpadlo
- RO Stația pt. evacuarea apelor uzate
- H Átemelő szivattyú
- E Estación de levantamiento para aguas residuales

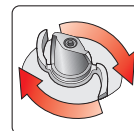

CUTTING SYSTEM / SYSTEM TNĄCY

230V~50Hz 800 W

Q max 270 l/min 3000 min<sup>-1</sup>

4 BLADES / OSTRZA 90°C max

IP44 2x Ø100 mm 2x Ø40 mm



FALA

No.	W	cube
75952	800	1

ANTI-ODOUR PROTECTION / ZABEZPIECZENIE ANTYZAPACHOWE

- PL Pistolet do udrażniania rur  
 GB Drain cleaner  
 D Pistole zum Reinigen von Rohren  
 RUS Пистолет для прочистки труб  
 CZ Pistolet na čištění trubek  
 RO Pistol pt. curățarea țevilor  
 H Csőtisztító pisztoly  
 E Pistola destapacaños



No.	Ø (mm)	Box
55500	135	10

- PL Przepychacz do udrażniania kanalizacji  
 GB Pipe cleaner  
 D Räumdom zum Reinigen der Kanalisation  
 RUS Поршень для прочистки канализации

- CZ Tlakový čistič kanalizace  
 RO Piston pt. deblocarea canalizării  
 H Lefolyótisztító pumpa  
 E Bomba destapacaños



No.	L (cm)	pcs	Box
55531	65	2	36

- PL Spirala kanalizacyjna  
 GB Drain auger  
 D Hand-Rohrreinigungsspirale  
 RUS Трос сантехнический пружинный

- CZ Spirála kanalizační  
 RO Dispozitiv de desfundat scurgere  
 H Csőtisztító spirál  
 E Desatascador espiral



No.	Ø (mm)	L (m)	Box
55544	9	5	5/10
55545	9	10	4/8

- PL Pompa do udrażniania kanalizacji  
 GB Drain suction pump  
 D Hochdruck-Rohrreiner  
 RUS Ручной насос для прочистки труб

- CZ Čerpadlo na čištění trubek  
 RO Pompă pt. curățarea țevilor  
 H Csőtisztító szivattyú  
 E El desagüe del fregadero limpiador



No.	Ø (mm)	Box
55505	65; 155	24

- PL Spirala kanalizacyjna  
 GB Drain auger  
 D Hand-Rohrreinigungsspirale  
 RUS Трос сантехнический пружинный

- CZ Spirála kanalizační  
 RO Dispozitiv de desfundat scurgere  
 H Csőtisztító spirál  
 E Desatascador espiral



No.	Ø (mm)	L (m)	Box
55541	5	1.5	20/80
55542	6	3	18/36



Memo

No.	Page	No.	Page	No.	Page	No.	Page	No.	Page	No.	Page	No.	Page	No.	Page
00300	132	04721	137	06302	145	06796	146	07881	104	08410	96	08755	82	09056	147
00320	132	05050	100	06303	145	06797	146	07882	104	08450	96	08770	85	09060	147
00500	132	05100	99	06304	145	06820	99	07883	104	08500	96	08771	85	09063	148
00510	132	05300	155	06305	145	06840	100	07884	104	08501	96	08773	85	09065	148
00600	132	05301	155	06306	145	06860	100	07885	104	08510	96	08780	82	09080	147
00610	132	05302	156	06307	145	06930	93	07886	104	08511	96	08781	82	09090	147
00703	132	05311	156	06308	145	06940	93	07891	104	08520	96	08782	82	09094	148
01060	132	05312	156	06309	145	06950	93	07894	104	08521	96	08783	82	09100	120
02300	132	05540	79	06310	145	06960	93	07910	104	08522	96	08785	82	09130	120
02400	132	05560	79	06320	145	06963	93	07911	104	08533	105	08786	82	09150	121
03150	133	05580	79	06330	145	06964	93	07912	104	08534	105	08787	82	09160	121
03160	133	05600	79	06331	145	06965	93	07913	104	08536	105	08788	82	09170	121
03220	133	05801	143	06335	146	06970	93	07914	104	08538	105	08790	82	09171	121
03221	133	05802	143	06340	143	06971	93	07915	104	08540	105	08791	82	09172	121
03240	78	05803	143	06341	143	06972	93	07916	104	08542	105	08792	82	09173	121
03241	78	05804	143	06350	143	06973	93	07920	105	08545	105	08793	82	09180	156
03245	78	05805	143	06351	143	06974	93	07950	105	08553	105	08811	83	09190	156
03246	78	05806	143	06360	143	06975	93	07960	106	08554	105	08819	83	09302	149
03300	79	05807	143	06370	143	06976	93	07962	106	08556	105	08820	83	09303	149
03301	79	05821	144	06380	143	06977	94	07970	105	08558	105	08821	83	09307	148
03900	134	05822	144	06388	155; 376	06978	94	07974	85	08560	105	08822	83	09308	148
03920	135	05823	144	06390	155; 376	06979	94	07975	85	08562	105	08825	83	09310	149
03940	135	05830	144	06391	155	06980	94	07976	85	08565	105	08827	83	09311	149
03950	135	05831	144	06392	155; 376	06981	94	07977	85	08573	105	08828	83	09331	149
03990	78	05840	144	06393	155; 376	06982	94	07978	85	08574	105	08829	83	09332	149
04000	133	05850	144	06394	155	06983	94	07984	85	08576	105	08831	83	09334	148
04001	133	05901	146	06395	155	06985	94	07985	85	08578	105	08832	83	09336	148
04020	133	05902	146	06396	155	06986	94	07986	85	08580	105	08833	83	09338	149
04022	133	05903	146	06397	155	06987	94	07987	85	08582	105	08834	83	09345	149
04050	135	05904	146	06398	155	06988	94	07988	85	08585	105	08835	83	09346	149
04100	135	05905	146	06399	155	06989	94	08170	83	08630	83	08836	83	09359	149
04131	134	05906	146	06400	141	06990	94	08171	83	08631	83	08837	83	09363	150
04200	133	05911	146	06401	141	06992	94	08174	83	08633	83	08838	83	09365	150
04210	133	05912	146	06410	141	06993	95	08175	83	08635	83	08845	83	09370	149
04300	42; 119	05913	146	06420	141	06994	95	08177	83	08636	83	08851	83	09371	149
04400	134	05914	146	06430	141	06995	95	08186	84	08638	83	08853	83	09372	149
04405	134	05915	146	06440	141	07060	103	08188	84	08639	83	08854	83	09373	149
04406	134	05916	146	06450	148	07080	103	08190	84	08640	83	08855	83	09375	150
04407	134	05921	146	06452	148	07100	103	08191	84	08641	83	08860	85	09377	150
04410	134	05922	146	06453	148	07120	103	08193	84	08642	83	08861	85	09378	150
04500	135	05923	146	06470	141	07180	103	08200	84	08644	83	08864	85	09385	150
04510	135	05924	146	06472	141	07240	103	08201	84	08646	83	08865	85	09390	150
04540	135	05925	146	06500	141	07320	103	08203	84	08656	83	08868	85	09395	150
04542	136	05926	146	06510	141	07400	103	08288	104	08658	83	08869	85	09400	155
04544	136	06030	144	06512	142	07506	103	08289	104	08663	84	08873	85	09406	150
04546	136	06040	144	06520	141	07508	103	08290	104	08665	84	08875	85	09408	150
04561	280	06050	144	06530	142	07510	103	08291	104	08669	84	08876	85	09412	150
04562	280	06060	144	06532	143	07512	103	08292	104	08671	84	09005	147	09413	150
04600	137	06080	144	06537	143	07530	103	08293	104	08672	84	09006	147	09421	150
04610	137	06100	144	06538	143	07540	103	08300	95	08674	84	09010	147	09422	150
04620	137	06110	143	06540	142	07560	103	08301	105	08681	84	09015	147	09425	150
04630	137	06120	143	06640	142	07580	103	08302	105	08683	84	09017	147	09427	150
04640	137	06130	145	06650	142	07610	103	08303	105	08710	81	09025	147	09429	150
04650	137	06140	145	06660	142	07620	103	08304	105	08711	81	09028	148	09430	150
04660	137	06150	145	06670	142	07630	103	08306	105	08712	81	09036	148	09457	152
04668	137	06290	145	06680	142	07650	103	08307	105	08714	81	09038	148	09459	152
04670	137	06294	145	06690	142	07652	104	08308	105	08715	81	09040	148	09462	152
04675	137	06295	145	06700	142	07664	104	08312	95	08731	82	09044	147	09463	152
04690	136	06296	145	06701	142	07665	104	08314	95	08732	82	09046	147	09465	281
04691	136	06297	145	06740	142	07666	104	08315	95	08734	82	09048	147	09466	281
04692	136	06298	145	06760	142	07667	104	08316	95	08735	82	09049	147	09467	281
04700	137	06299	145	06780	142	07668	104	08318	95	08751	82	09050	147	09470	153; 281
04710	137	06300	145	06781	142	07879	104	08350	96	08752	82	09051	147	09471	153; 281
04720	137	06301	145	06795	146	07880	104	08400	96	08754	82	09054	147	09475	153; 281

No.	Page	No.	Page	No.	Page	No.	Page	No.	Page	No.	Page	No.	Page	No.	Page
09476	153; 281	10133	160	17505	162	21924	74	23376	76	23730	76	24950	80	27511	91
09477	153; 281	10135	160	17507	162	21927	74	23377	76	23740	76	24960	80	27513	91
09478	153; 281	10138	160	17508	162	21929	74	23378	76	23750	76	24961	80	27520	91
09480	281; 376	10139	160	17606	166	21932	74	23379	76	23752	76	24962	80	27540	134
09481	281; 376	11603	160	17608	166	21934	74	23380	76	23800	76	24963	80	27575	82
09482	281; 376	11605	160	17610	166	21936	74	23381	76	23820	76	24964	80	27600	89
09486	281	11608	160	17612	166	21941	74	23382	76	23830	76	24965	80	27800	91
09487	281	12100	160	17615	166	21944	74	23383	76	23832	76	24966	80	27810	92
09489	281	12200	160	17620	166	21948	74	23390	76	23840	76	25160	101	27811	92
09490	281	12300	160	17701	140; 377	21950	74	23391	76	23850	76	25161	101	27812	92
09521	151	12500	160	17704	140; 377	21951	74	23392	76	23860	76	25162	101	27813	92
09522	151	12502	160	17705	141; 377	21952	74	23393	76	23862	76	25163	101	27814	92
09523	151	12503	160	18200	164	21955	74	23394	76	23880	76	25164	101	27815	92
09524	151	13200	160	18201	164	21956	74	23395	76	23882	76	25165	101	27820	92
09525	151	13300	160	18250	164	21958	74	23396	76	23883	76	25166	102	27830	92
09531	151	13500	160	18300	164	21961	74	23397	76	23920	76	25170	102	27831	92
09532	151	14100	160	18350	164	21963	74	23398	76	23930	76	25171	102	27832	92
09533	151	14200	160	18360	164	21966	74	23399	76	23932	76	25172	102	27833	92
09534	151	14300	160	18361	164	21998	74	23400	76	23960	76	25173	102	27834	92
09535	151	14500	160	18362	164	21999	74	23401	76	23962	76	25230	103	28000	88; 144
09536	151	15004	161	18501	165	22130	73	23402	76	23980	76	25351	102	28010	88; 144
09537	151	15005	161	18502	165	22180	73	23403	76	23982	76	25352	102	28011	89; 144
09560	151	15006	161	18503	165	22190	73	23411	76	23988	76	25353	102	28012	89; 144
09561	151	15007	161	18504	165	22250	73	23412	76	23990	76	25360	102	28380	87
09562	151	15010	161	18797	165	22300	73	23413	76	23992	76	25370	102	28381	87
09581	151	15020	161	18798	165	22310	73	23414	76	23999	76	25380	102	28382	87
09583	151	15050	161	18799	165	22330	73	23415	76	24000	81	25390	102	28385	88
09585	151	15070	161	18800	165	22340	73	23416	76	24295	81	25400	232	28386	88
09587	151	15071	161	18810	165	22350	75	23417	76	24300	79	25410	232	28387	88
09589	151	15100	161	19750	165	22380	75	23418	76	24310	79	25411	233	28394	88
09636	151	15110	161	19770	165	22381	75	23419	76	24320	79	25412	233	28395	88
09638	151	15130	161	20100	73	22460	75	23420	76	24330	79	25450	232	28640	347
09640	151	15200	161	20150	73	22465	75	23421	76	24340	79	25500	59	28641	347
09642	151	15220	161	20200	73	22466	75	23422	76	24350	79	25510	59	28642	347
09647	151	15240	162	20250	73	22500	75	23423	76	24370	80	25511	59	28650	88
09648	151	16000	166	20280	73	22550	81	23424	76	24390	80	25512	59	28680	79
09649	151	16001	166	20300	73	22551	81	23585	77	24410	80	25513	59	28690	79
09650	152	16002	166	20320	73	22565	78	23586	78	24430	80	25514	59	28710	79
09651	151	16340	166	20350	73	22570	78	23590	76	24450	80	25515	59	28720	79
09653	152	16360	166	20400	73	22571	79	23591	77	24470	80	25516	59	28725	79
09920	151	16380	166	20420	73	22572	78	23592	77	24500	80	25517	59	28733	79
09930	151	16400	166	20450	73	23311	74	23593	77	24510	80	25518	59	28740	88; 347
09950	151	16551	166	20500	73	23312	74	23601	77	24520	80	25519	59	28745	88; 348
10000	282	16552	166	20550	73	23313	74	23602	77	24530	80	25520	59	28746	88; 348
10001	282	16553	166	20600	73	23314	74	23603	77	24540	80	25521	59	28750	88; 347
10002	282	16554	166	20650	73	23315	74	23604	77	24550	80	25530	59	28755	88; 348
10004	282	16555	166	20700	73	23316	74	23605	77	24570	80	25700	59	28771	88; 348
10010	282	16556	166	20800	73	23317	74	23606	77	24590	80	25830	101	28772	88; 348
10011	282	16557	166	20850	73	23318	74	23608	77	24610	80	25860	101	28773	88; 348
10012	282	17300	164	20900	73	23319	74	23620	76	24630	80	25880	101	28790	89
10013	282	17470	127; 163	21000	73	23320	74	23640	76	24650	80	26150	103	29000	90
10014	282	17471	127; 163	21100	73	23321	74	23650	76	24670	80	26200	103	29050	90
10015	282	17473	127; 163	21200	73	23324	74	23660	76	24700	80	26210	103	29090	91
10101	160	17474	127; 163	21250	73	23325	74	23670	76	24710	80	27000	89	29100	91
10104	160	17480	127; 163	21300	73	23326	74	23680	76	24730	80	27100	89	29210	90
10106	160	17481	127; 163	21400	73	23327	74	23690	76	24740	81	27200	89	29220	90
10109	160	17483	127; 163	21600	73	23328	74	23692	76	24750	81	27322	89	29311	90
10111	160	17484	127; 163	21650	74	23329	74	23693	76	24800	81	27495	89	29312	90
10122	160	17488	126; 162	21900	74	23331	75	23694	76	24810	81	27500	91	29313	90
10123	160	17489	126; 162	21905	74	23371	76	23710	76	24813	81	27501	91	29317	90
10125	160	17490	126; 162	21910	74	23372	76	23720	76	24820	81	27502	91	29318	90
10128	160	17495	126; 162	21915	74	23373	76	23722	76	24823	81	27505	91	29319	90
10129	160	17500	162	21919	74	23374	76	23723	76	24900	80	27506	91	29323	90
10130	160	17501	162	21921	74	23375	76	23724	76	24940	80	27510	91	29992	57

No.	Page	No.	Page	No.	Page	No.	Page	No.	Page	No.	Page	No.	Page	No.	Page
29993	57	32627	58	34208	61	35777	358	35881	280; 360	38404	66	43020	43	49802	156
29994	57	32685	57	34210	61	35779	357	35889	280; 360	38406	66	43021	43	49805	156
29995	57	32687	58	34212	61	35780	357	35893	279; 361	38407	66	43030	44	49806	156
29996	57	32705	58	34220	61	35781	357	35894	279; 361	38408	66	43031	44	50070	10
29997	57	32715	58	34222	61	35782	357	35895	279; 361	38409	66	43040	44	50090	10
30010	56	32720	57	34225	61	35783	357	35899	280; 361	38430	67	43041	44	50100	10
30020	56	32900	63	34243	60	35784	357	35905	280; 361	38431	67	43050	44	50110	10
30030	56	32901	62	34245	60	35785	357	35906	280; 361	38432	67	43051	44	50120	10
30040	56	32902	62	34247	60	35786	358	35908	280; 361	38433	67	43052	44	50130	10
30050	56	32922	63; 350	34251	60	35787	359	35911	279; 360	38434	67	43053	44	50150	10
30060	56	32923	63; 350	34254	60	35788	358	35912	279; 360	38435	67	43055	44	50170	10
30080	56	32924	62; 349	34256	60	35789	358	35914	279	38436	67	43056	44	50190	10
30100	56	32925	62; 349	34300	60	35790	359	35915	279	38500	66	43057	44	50220	10
30150	56	32926	62; 349	34600	60	35791	359	35916	279	38515	66	43058	44	50270	10
30200	56	32927	62; 349	34750	60	35792	357	35918	279	38525	66	43060	44	50330	10
30310	56	32928	62; 349	34900	60	35793	359	35923	279	38750	66	43061	44	50560	10
30320	56	32930	61; 348	34944	146	35794	359	35924	279	38751	67	43062	44	50580	10
30330	56	33000	62; 349	34945	146	35795	360	36000	67	38830	67	43063	44	50590	10
30340	56	33001	62; 349	34946	146	35799	354	36004	67	40010	40	43140	44	50610	10
30350	56	33002	62; 349	34947	146	35800	354	36005	67	40011	40	43500	44	50620	10
30360	56	33003	62; 349	34949	377	35801	354	36006	67	40012	40	43510	45	50630	10
30380	56	33004	62; 349	34950	156	35802	354	36008	67	40013	40	44100	45	50850	8
30390	56	33005	62; 349	35250	59	35803	355	36014	67	40014	40	44102	45	50861	8
30395	56	33006	62; 349	35300	59	35805	355	36015	67	40015	40	44300	45; 241	50871	8
30400	56	33007	62; 349	35351	59	35806	355	36016	67	40016	40	44301	45; 241	50880	8
30410	56	33008	62; 349	35352	59	35807	355	36018	67	40017	40	44400	45; 242	51060	8
30420	56	33022	62; 349	35353	59	35808	355	36032	68	40018	40	44500	45; 242	51070	8
30430	56	33024	61; 349	35355	59	35809	353	36033	68	40041	40	45000	50	51080	8
30440	56	33026	61; 349	35359	60	35810	353	36034	68	40042	40	45010	51	51090	8
30450	56	33028	61; 349	35360	60	35813	356	36037	68	40043	40	45012	51	51100	8
30460	56	33030	61; 349	35362	60	35815	356	36038	68	40044	40	45020	51	51110	8
30480	56	33032	61; 349	35364	60	35816	356	36039	68	40045	40	45050	50	51120	8
30500	56	33035	61; 349	35366	60	35817	353	36570	68; 110	40047	40	45100	50	51130	8
30510	56	33038	61; 349	35368	60	35821	361	36650	68	40048	40	45103	50	51140	8
30520	56	33039	61; 349	35372	60	35823	362	37100	66	40050	40	45150	50	51150	8
30531	56	33040	61; 349	35373	60	35824	361	37101	66	40051	40	45151	50	51160	8
30532	56	33065	61; 348	35374	60	35826	361	37102	66	40054	41	45201	51	51170	8
30533	56	33067	61; 348	35376	60	35828	361	37103	66	40055	41	45500	50	51180	8
30534	56	33080	61; 348	35430	60	35830	362	37104	66	40056	41	45503	50	51190	8
30535	56	33085	61; 348	35670	354	35831	362	37106	66	40057	41	48000	85; 242	51200	8
30536	56	33087	61; 348	35671	354	35832	361	37107	66	40160	42	48050	86; 243	51210	8
31010	56	33105	61; 348	35680	354	35839	355	37108	66	40180	42	48060	86; 242	51220	8
31030	56	33107	61; 348	35700	358	35840	355	37109	66	40200	42	48070	86; 243	51240	8
31050	56	33125	61; 348	35710	359	35842	356	37110	66	40700	42	48080	86; 242	51270	8
31070	56	33127	61; 348	35750	358	35843	353	37111	66	41121	41	48081	86; 243	51300	8
31100	56	33147	61; 348	35751	358	35846	355	37112	66	41151	41	48082	86; 242	51320	8
31150	56	33177	61; 348	35755	358	35850	356	37113	66	41152	41	48100	86; 242	51560	8
31200	56	33535	58	35756	354	35860	356	37114	66	41180	41	48150	87; 243	51580	8
31300	56	33550	58	35757	354	35861	353	37115	66	41200	41	48200	86; 242	51590	8
31400	56	33555	58	35758	354	35863	353	37150	66	41381	42	48330	87; 243	51620	8
31500	56	33557	58	35759	354	35864	356	37200	66	41500	41	49200	87	51630	8
31600	56	33650	58	35760	360	35865	356	37250	66	41510	45; 110	49450	87	51640	8
31800	56	33655	58	35761	354	35866	356	37300	66	42300	42	49460	87	51645	8
32000	56	33657	58	35762	354	35867	279	37380	66	42301	42	49600	87	51650	8
32110	57; 241	33900	58	35763	357	35868	279	37400	66	42302	43	49750	87	51671	9
32201	57	33905	58	35764	357	35869	279	37430	66	42303	42	49760	87	51672	9
32202	57	33907	58	35765	352	35870	279	37500	66	42304	43	49770	87	51673	9
32203	57	33925	58	35767	352	35872	279	37800	66	42305	42	49771	87	51674	9
32204	57	33927	58	35768	352	35874	279	37900	66	42306	43	49772	87	51675	9
32205	57	33950	59; 241	35770	358	35875	279	38150	66	42307	43	49773	87	51676	9
32206	57	34204	61	35773	358	35876	279	38200	66	42308	43	49774	87	51677	9
32207	57	34205	61	35774	358	35877	279	38401	66	42309	43	49775	87	51678	9
32208	57	34206	61	35775	359	35878	281; 360	38402	66	43010	43	49800	156	51679	9
32625	57	34207	61	35776	357	35880	280; 360	38403	66	43011	43	49801	156	51680	9

No.	Page	No.	Page	No.	Page	No.	Page	No.	Page	No.	Page	No.	Page	No.	Page
51681	9	52847	11	54000	12	55690	46; 111	57651	185	60939	26	61382	28	66410	33
51682	9	52850	12	54034	13	55740	112	57700	188	60950	26	61383	28	66570	34
51683	9	52851	12	54061	13	55792	47; 111	58140	19	60951	26	61384	28	66580	34
51684	9	52852	12	54062	13	55800	110	58150	19	60952	26	61385	28	66710	34
51685	9	52853	12	54063	13	55820	110	58160	17	60953	26	61386	28	66720	34
51686	9	52854	12	54065	13	55830	110	58210	18	60954	26	61392	28	66760	34
51687	9	52855	12	54066	13	56040	35	58240	18	60955	26	61393	28	66770	34
51688	9	52860	11	54067	13	56050	35	58260	18	60956	26	61394	28	69493	127; 163
51689	9	52900	12	54068	13	56060	35	58520	18	60957	26	61395	28	69502	127; 163
51690	9	52932	12	54070	13	56070	35	58530	18	60958	26	61550	28	69503	127; 163
51691	9	52933	12	54071	13	56080	35	58539	182	60959	26	61560	28	69504	127; 163
51692	9	52935	12	54072	13	56100	35	58540	182	60961	26	61580	28	69505	127; 163
51693	9	52936	12	54073	13	56120	35	58600	18	60962	26	61590	28	69506	127; 163
51694	9	53080	16	54080	13	56130	35	58602	18	60963	26	61600	28	69507	127; 163
51695	9	53100	16	54081	13	56140	35	58640	19	60964	26	61640	29	69508	127; 163
51696	9	53120	16	54499	47; 111	56170	35	58641	19	60965	26	64050	31	69509	127; 163
51705	9	53130	16	54500	47; 111	56380	35	58642	19	60966	26	64060	31	69510	127; 163
51710	9	53140	16	54510	47; 111	56390	35	58643	19	60967	26	64070	32	69521	127; 163
51715	9	53150	16	54600	12	56391	35	58661	20	60968	26	64090	32	69539	128; 164
51720	9	53160	16	54610	12	56392	35	58682	21	60969	26	64310	32	69540	128; 164
51721	9	53170	16	54620	12	56393	36	58683	21	60970	26	64330	32	69542	128; 164
51722	9	53180	16	54630	12	56400	36	58685	21	60975	26	64370	32	69543	128; 164
51740	10	53190	16	54640	12	56470	36	58686	20	60976	27	64371	32	69546	128; 164
51741	10	53210	16	54650	12	56473	36	58687	21	61010	27	64395	32	69550	128; 164
52100	11	53220	16	54660	12	56475	36	58688	22	61020	27	64396	32	69551	128; 164
52110	11	53240	16	54670	12	56477	36	58689	20	61030	27	64553	33	69552	128; 164
52120	11	53270	16	54680	12	56478	37	58690	22	61040	27	64554	33	69572	127; 163
52130	11	53300	16	54690	12	56505	36; 269	58691	23	61050	27	64650	31	69602	127; 163
52170	11	53320	16	54700	12	56506	36; 269	58700	22	61060	27	64654	29	69608	128; 164
52190	11	53400	16	54710	12	56507	37; 270	58704	20	61070	27	64655	30	69609	128; 164
52220	11	53410	16	54720	12	56550	37	60880	26	61080	27	64657	30	69610	128; 164
52270	11	53420	16	54730	12	56600	37	60881	26	61090	27	64658	30	69612	128; 164
52340	11	53430	16	54750	12	56710	12	60882	26	61100	27	64660	30	69613	128; 164
52560	11	53440	16	54760	12	56720	12	60883	26	61110	27	64950	29	69620	127; 163
52570	11	53450	16	54780	12	56730	12	60884	26	61120	27	64951	29	69621	127; 163
52580	11	53460	16	54860	12	56740	12	60885	26	61130	27	65040	29	69630	127; 163
52630	11	53470	16	55100	46; 111	56750	12	60886	26	61140	27	65041	29	69631	127; 163
52652	10	53480	16	55150	46; 111	56770	12	60887	26	61150	27	65045	31	69635	128; 164
52653	10	53490	16	55200	46; 111	56780	12	60888	26	61160	27	65080	30	69637	128; 164
52654	10	53500	17	55210	46; 111	56790	12	60889	26	61170	27	65100	31	69850	378
52655	10	53520	17	55211	46; 111	57000	186	60890	26	61210	27	65120	31	69851	378
52656	10	53540	17	55212	46; 111	57010	187	60891	26	61220	27	65122	31	70000	118
52657	10	53560	17	55215	46; 111	57020	187	60910	29	61230	27	65150	31	70020	118
52658	10	53561	17	55216	46; 111	57030	187	60912	26	61240	27	65170	30	70023	118
52659	10	53562	17	55217	46; 111	57050	187	60913	26	61250	27	65233	51	70030	118
52660	10	53563	17	55220	46; 111	57091	189; 216	60914	26	61260	27	65235	51	70050	118
52661	10	53571	17	55221	46; 111	57100	187	60915	26	61270	27	65260	188	70100	118
52680	11	53572	17	55222	46; 111	57160	187	60916	26	61280	27	65270	188	70150	118
52700	11	53573	17	55250	46; 110	57210	187	60917	26	61290	27	65520	33	70160	118
52710	11	53575	17	55300	46; 110	57260	187	60918	26	61300	28	65610	33	70200	119
52720	11	53576	17	55350	46; 110	57300	13	60920	26	61310	28	65620	33	70201	119
52730	11	53577	17	55500	114; 285; 400	57350	13	60921	26	61320	28	65630	33	70210	119
52740	11	53580	17	55505	115; 285; 400	57400	13	60922	26	61330	28	65640	33	70270	119
52750	11	53598	16	55531	115; 285; 400	57450	13	60923	26	61340	28	65650	33	70320	119
52770	11	53599	16	55541	115; 285; 400	57600	185	60924	26	61350	28	65700	33	70330	119
52790	11	53600	16	55542	115; 285; 400	57610	185	60930	29	61360	28	65800	33	70340	119
52820	11	53610	16	55544	115; 285; 400	57612	186	60931	26	61370	28	65850	35	70400	119
52840	11	53630	16	55545	115; 285; 400	57613	186	60932	26	61375	28	66080	34	70410	119
52841	11	53650	16	55620	46; 111	57614	186	60933	26	61376	28	66112	34	70420	119
52842	11	53670	16	55625	46; 111	57620	185	60934	26	61377	28	66113	35	70430	119
52843	11	53700	16	55630	46; 111	57630	185	60935	26	61378	28	66200	35	70480	119
52844	11	53710	16	55635	46; 111	57640	185	60936	26	61379	28	66210	35	70490	119
52845	11	53730	17	55645	46; 111	57649	185	60937	26	61380	28	66330	33	70500	119
52846	11	53760	16	55660	46; 111	57650	185	60938	26	61381	28	66400	33	70510	119

No.	Page	No.	Page	No.	Page	No.	Page	No.	Page	No.	Page	No.	Page	No.	Page
71000	119	72080	120	72808	312	72944	277	73352	140	73700	122	74127	301; 370	74456	241; 308
71040	120	72100	120	72809	312	72945	277	73353	140	73710	122	74128	301; 370	74457	240; 307
71042	120	72120	120	72821	312	72948	277	73360	140	73720	122	74130	301; 370	74459	304
71050	120	72140	120	72822	312	72950	277	73362	140	73730	122	74131	301; 370	74460	304
71052	120	72400	320	72823	312	72951	277	73400	113; 137	73740	122	74132	301; 370	74461	308; 374
71060	120	72401	320	72824	312	72952	277	73403	113; 137	73775	122	74133	301; 370	74462	308; 374
71800	395	72402	320	72825	312	72953	277	73410	113; 138	73820	122	74134	301; 370	74463	308
71801	395	72404	319	72826	312	72954	277	73412	113; 138	73831	122	74135	301; 370	74464	308
71802	395	72407	319	72827	312	72956	277	73413	113; 138	73833	122	74136	301; 370	74466	309
71803	395	72451	319	72828	312	72958	277	73470	231	73835	122	74137	301; 370	74467	309
71804	395	72452	319	72829	312	72960	277	73473	232	73836	122	74140	303	74480	240; 307
71805	395	72455	319	72831	311; 371	72963	277	73500	233	73838	122	74142	304	74481	240; 307
71807	395	72484	318	72832	311; 371	72964	277	73506	123; 340	73881	123	74145	303	74482	240; 307
71808	395	72486	318	72833	311; 371	72965	277	73507	123; 340	73882	123	74146	303	74501	304; 374
71809	395	72489	318	72834	311; 371	72966	277	73508	123; 340	73883	123	74148	303	74502	304; 374
71810	395	72490	318	72835	311; 371	72967	277	73510	123; 340	73884	123	74150	302	74503	304; 374
71811	395	72493	318	72836	311; 371	72968	277	73511	123; 340	73885	123	74151	302	74504	304; 374
71812	395	72494	318	72840	311; 372	72969	277	73515	121	73886	123	74152	303	74508	305; 375
71814	395	72500	318	72841	311; 372	72970	277	73516	121	73887	123	74153	303	74509	305; 375
71815	395	72501	318	72842	311; 372	72974	278	73517	121	73888	123	74154	303	74540	305
71816	395	72504	318	72843	311; 372	72975	278	73521	121	73891	123	74160	302	74541	305
71817	395	72505	318	72844	311; 372	72976	278	73522	121	73892	123	74162	302	74542	305
71818	395	72506	318	72845	311; 372	72977	278	73523	121	73893	123	74164	302	74543	305
71819	395	72508	318	72846	311; 372	72978	278	73525	121	73894	123	74190	310; 373	74580	310; 374
71820	395	72509	318	72850	311; 372	72979	278	73527	121	73895	123	74191	310; 373	74581	310; 374
71821	395	72510	318	72851	311; 372	72981	278	73528	121	73896	123	74192	310; 373	74600	309; 372
71822	395	72524	318	72852	311; 372	72984	278	73529	121	73897	123	74193	310; 373	74601	310; 373
71823	395	72525	318	72853	311; 372	72985	278	73530	121	73898	123	74194	310; 373	74602	310; 373
71824	395	72526	318	72854	311; 372	72988	275	73532	121	73906	123	74195	310; 373	74610	309; 372
71825	395	72527	318	72855	311; 372	72989	275	73533	121	73909	123	74201	310; 373	74620	309; 372
71827	395	72528	318	72859	311; 372	72990	275	73534	121	73929	123	74220	314	74622	309; 373
71828	395	72529	318	72860	311; 372	72994	277	73535	121	74000	300	74221	314	74623	310; 373
71829	395	72530	318	72861	311; 372	72995	277	73536	121	74001	300	74222	314	74624	309; 373
71830	395	72531	318	72862	311; 372	72996	277	73539	121	74004	300	74223	314	74626	313
71831	395	72532	318	72863	311; 372	72997	277	73540	121	74077	303	74224	314	74627	313
71832	395	72533	318	72864	311; 372	72998	277	73561	122	74078	303	74225	238	74628	313
71833	395	72534	318	72871	311	73002	275	73562	122	74079	303	74230	238	74631	313
71834	395	72535	318	72872	311	73003	276	73563	122	74080	303	74311	238	74632	313
71835	395	72570	319	72873	311	73004	276	73565	122	74081	304	74316	238	74633	313
71836	395	72572	319	72874	311	73005	276	73567	122	74082	304	74400	238; 305	74635	313
71837	395	72573	319	72875	311	73006	276	73568	122	74084	303	74410	238; 305	74636	313
71838	395	72615	318	72876	311	73040	223	73569	122	74085	303	74411	238; 306	74637	313
71840	396	72616	318	72877	311	73051	224	73570	122	74086	303	74420	238	74638	313
71841	396	72617	318	72890	312	73052	218	73571	122	74087	302	74421	238	74639	313
71842	396	72620	318	72891	312	73056	211	73572	122	74088	302	74422	238	74640	310
71843	396	72621	318	72900	314; 375	73057	211	73573	122	74089	302	74430	238	74646	314
71844	396	72622	318	72901	314; 375	73058	210	73574	122	74094	300	74431	238	74647	314
71846	396	72625	318	72902	314; 375	73059	211	73575	122	74100	300; 370	74432	238	74652	152; 313
71847	396	72626	318	72903	314; 375	73060	224	73590	122	74102	300	74435	240; 307	74660	313
71848	396	72627	318	72920	283	73260	123; 233	73598	122	74103	300	74436	240; 307	74661	313
71849	396	72630	318	72921	284	73270	123; 233	73612	122	74104	300	74439	241; 309	74662	313
71850	396	72631	318	72922	284	73271	123; 233	73614	122	74105	300	74440	238; 306	74663	313
71851	396	72632	318	72928	283	73300	123; 233	73616	122	74106	300	74441	239; 306	74664	313
71852	396	72683	312	72931	284	73325	138	73620	122	74107	300	74442	239; 306	74665	313
71853	396	72684	312	72932	284	73330	138	73621	122	74108	301	74443	239; 306	74666	313
71854	396	72685	312	72933	276	73331	138	73625	122	74110	301; 370	74447	239; 306	74667	313
71855	396	72686	312	72934	276	73332	139	73627	122	74111	301; 370	74448	239; 306	74680	296
71856	396	72801	312	72935	276	73340	139	73632	122	74113	302; 371	74449	241; 308	74681	296
71857	396	72802	312	72936	276	73341	139	73640	122	74115	302; 371	74450	239; 306	74685	296
71858	396	72803	312	72937	276	73342	139	73645	122	74117	301; 371	74451	241; 308	74688	296
71859	396	72804	312	72938	277	73343	139	73660	122	74121	301; 371	74452	241; 308	74689	296
71860	396	72805	312	72939	277	73344	139	73670	122	74123	302; 371	74453	241; 308	74695	296
72040	120	72806	312	72942	277	73350	140	73680	122	74125	301; 370	74454	241; 308	74702	296
72060	120	72807	312	72943	277	73351	140	73695	122	74126	301; 370	74455	241; 308	74730	292



No.	Page	No.	Page	No.	Page	No.	Page	No.	Page	No.	Page	No.	Page	No.	Page
74731	292	74921	291	75295	123	75573	394	76160	98	76905	253	77250	248	78432	246
74732	292	74922	291	75300	124; 154	75574	393	76180	98	76906	253	77300	248	78434	246
74733	293	74923	291	75301	124; 154	75578	394	76181	98	76910	254	77350	248	78436	246
74734	293	74924	291	75302	124; 154	75579	394	76182	98	76911	254	77400	248	78450	295
74740	293	74930	291	75303	124; 154	75594	394	76183	98	76912	254	77500	248	78451	295
74741	293	74932	291	75304	124; 154	75595	394	76184	98	76913	254	77600	248	78463	255
74742	293	74933	291	75327	388	75596	394	76185	99	76914	254	77603	248	78480	250
74743	293	74935	291	75328	389	75597	394	76190	99	76915	254	77607	249	78481	250
74744	293	74936	291	75329	389	75598	394	76210	99	76930	254	77700	249	78482	250
74750	293	74937	291	75330	389	75599	394	76214	99	76931	254	77715	270	78490	251
74751	294	74941	292	75331	389	75620	393	76220	99	76933	254	77795	269	78491	251
74752	294	74944	292	75332	389	75621	393	76230	99	76934	254	77815	256; 267	78493	251
74753	294	74945	292	75333	389	75622	393	76250	99	76941	254	77830	255; 266	78494	251
74754	294	74960	292	75360	388	75623	393	76280	99	76942	254	77831	255; 266	78500	252
74760	294	74973	296	75361	388	75624	392	76305	100	76943	254	77833	255; 266	78501	252
74761	294	74974	296	75362	388	75625	392	76311	100	76944	254	77834	255; 266	78510	252
74765	294	74975	296	75363	388	75626	392	76312	100	76945	254	77835	255; 266	78511	252
74766	294	74980	297	75364	388	75627	392	76314	100	76951	254	77837	256; 266	78513	253
74771	295	74983	297	75365	388	75629	392	76320	51	77004	247	77838	256; 266	78520	253
74772	295	75000	126	75366	388	75631	392	76526	97	77005	247	77840	256; 267	78525	253
74773	295	75012	126	75367	388	75660	397	76621	97	77006	247	77845	256; 266	78526	253
74775	295	75028	126	75368	388	75661	397	76622	97	77010	247	77850	256; 267	78550	274
74776	295	75031	126; 154	75369	388	75685	387	76640	97	77020	247	77851	256; 267	78551	274
74777	295	75035	126	75370	388	75686	387	76650	97	77030	247	77852	256; 267	78552	274
74802	289	75036	126	75371	388	75687	387	76660	97	77040	247	77860	256; 267	78553	274
74804	289	75050	126	75372	388	75688	387	76700	100	77050	247	77861	257; 267	78555	274
74812	289	75060	126	75373	388	75689	387	76705	100	77051	247	77870	257; 268	78556	274
74816	289	75100	125; 154	75374	389	75740	384	76710	100	77052	247	77871	257; 268	78557	274
74818	289	75120	124; 153	75375	389	75742	384	76750	288	77053	247	77872	257; 268	78560	274
74820	289	75121	124; 153	75376	389	75743	384	76751	288	77054	247	77881	257; 267	78561	274
74828	289	75122	124; 153	75377	389	75745	386	76752	288	77055	247	77900	254	78562	274
74831	289	75123	124; 153	75378	389	75747	386	76755	288	77061	247	77910	255	78570	274
74833	289	75124	124; 153	75379	389	75748	387	76756	289	77062	247	77920	255	78571	274
74835	289	75125	124; 153	75380	389	75749	387	76757	288	77063	247	77921	255	78572	274
74838	289	75130	124; 153	75470	399	75760	385	76760	288	77064	247	77930	255	78575	274
74841	289	75131	124; 153	75483	390	75762	385	76761	288	77110	248	78000	184	78576	274
74843	289	75132	124; 153	75484	390	75763	385	76762	288	77120	248	78020	284	78577	274
74846	290	75133	124; 153	75485	390	75764	386	76765	288	77130	248	78021	285	78580	274
74849	290	75140	125; 153	75486	390	75765	386	76766	289	77140	248	78022	285	78581	274
74851	290	75141	125; 153	75487	390	75767	386	76767	288	77150	248	78030	184	78582	274
74853	290	75200	114	75488	390	75768	386	76768	288	77170	249	78031	184	78585	275
74855	290	75201	114	75498	390	75770	384	76800	233	77171	249	78035	184	78586	275
74856	290	75202	114	75499	390	75772	385	76806	233	77180	249	78040	182	78587	275
74858	290	75230	125	75540	391	75773	385	76807	233	77185	250	78041	183	78590	275
74861	290	75231	125	75541	391	75774	385	76810	233	77187	250	78042	183	78591	275
74863	290	75233	125	75543	391	75910	397	76811	234	77188	250	78043	183	78592	275
74866	290	75238	125; 154	75544	391	75911	397	76814	234	77190	249	78044	184	78611	246
74869	290	75239	125; 154	75545	391	75912	398	76815	234	77191	249	78045	183	78612	246
74882	290	75240	125; 154	75548	391	75914	398	76818	234	77192	249	78046	183	78613	246
74883	290	75245	125; 154	75550	391	75915	292; 399	76819	234	77193	249	78047	183	78614	247
74885	291	75246	125; 154	75551	391	75916	292; 399	76820	234	77195	250	78050	183	78615	247
74886	291	75247	125; 154	75552	392	75950	399	76822	234	77196	250	78061	183	78616	247
74887	291	75260	125; 154	75553	393	75952	399	76823	234	77200	249	78067	184	78620	246
74894	291	75261	125; 154	75554	393	75970	398	76824	234	77203	249	78068	184	78622	246
74895	291	75262	125; 154	75555	396	75971	398	76826	234	77204	249	78300	184	78624	246
74896	291	75270	124; 153	75556	396	75972	398	76827	234	77205	249	78303	185	78626	247
74898	291	75271	124; 153	75558	397	75973	398	76828	234	77210	248	78306	184	78628	247
74904	291	75272	124; 153	75559	397	75974	398	76830	234	77211	248	78341	112	78630	247
74910	291	75273	124; 153	75562	392	75992	398	76832	234	77212	248	78381	112	78632	247
74911	291	75274	124; 153	75564	393	75993	398	76835	234	77213	248	78385	112	78633	247
74912	291	75285	124; 153	75565	393	76000	97	76836	234	77230	248	78400	188	78641	246
74913	291	75286	124; 153	75570	394	76010	97	76900	253	77231	248	78401	188	78642	246
74914	291	75287	124; 153	75571	394	76011	98	76901	253	77232	248	78402	188	78660	286
74920	291	75288	124; 153	75572	394	76015	98	76902	253	77241	248	78405	188; 325	78661	286

No.	Page	No.	Page	No.	Page	No.	Page	No.	Page	No.	Page	No.	Page	No.	Page
78700	260	79018	206	79379	212	79909	213; 342	80450	193	81640	173	82386	200	82844	321
78710	260	79023	214	79380	212	79912	225; 343	80500	186	81644	173	82388	200	82845	322
78720	260	79024	221	79381	212	79913	225; 343	80510	186	81647	173	82390	200	82846	322
78730	260	79026	206	79382	211	79914	225; 343	80520	186	81650	171	82392	200	82847	322
78750	260	79030	214	79383	211	79919	231	80530	186	81653	171	82393	200	82848	322
78785	261	79036	215	79385	211	79926	226; 343	80534	186	81661	171	82395	200	82910	197
78790	261	79046	221	79386	233	79927	226; 343	80600	186	81761	166	82397	201	82920	197
78791	261	79047	206	79390	234	79928	226; 343	80601	186	81762	166	82400	200	82939	197
78793	261	79048	206	79391	235	79929	226; 343	80620	186	81771	166	82431	197	82941	233
78794	261	79053	206	79395	235	79930	226; 343	80640	186	81780	51	82440	196	82942	222
78800	260	79060	221	79398	234	79931	226; 343	80660	187	81781	165	82445	196	82951	198; 284
78801	260	79087	216	79410	210	79932	226; 343	80661	187	81782	165	82501	197	83000	197
78802	260	79088	216	79413	210	79933	226; 343	80751	194	81783	52	82502	197	83001	197
78811	260	79089	216	79442	227; 367	79942	213; 342	80752	194	81784	52	82504	197	83002	198
78812	260	79099	208	79444	227; 367	79960	340	80753	194	81785	165	82506	197	83004	198
78813	260	79104	216	79448	227; 367	79962	340	80901	172	81820	189	82520	197	83005	198
78814	260	79105	216	79456	226; 366	79963	340	80902	172	81823	188	82550	193	83260	198
78815	260	79108	216	79467	227; 366	79965	340	81100	170	81824	189	82551	193	83261	198
78816	261	79116	221	79468	229; 368	79968	340	81101	170	81825	189	82552	194	83262	198
78818	261	79118	208	79475	209	79971	340	81108	170	81830	182	82553	194	83266	199
78819	261	79129	208	79477	209	79973	340	81109	170	82000	194; 268	82610	194	83267	199
78821	261	79140	216	79478	209	79975	340	81110	170	82001	194; 268	82611	194	83270	198
78822	261	79141	208	79479	222	79977	235	81114	170	82005	194; 268	82650	194	83280	199
78824	261	79150	222	79481	223	79978	235	81115	171	82015	195; 269	82671	319; 378	85020	201; 283
78825	261	79203	212	79482	217	79979	235	81117	171	82020	195; 269	82673	319; 378	85030	201; 283
78826	261	79205	219	79491	217	79982	235	81118	171	82021	195; 269	82675	319; 378	85040	201; 283
78830	262	79206	219	79493	222	79983	235	81133	171	82022	195; 269	82677	319	85050	201; 283
78831	262	79207	219	79493	222	79984	235	81142	171	82031	268	82682	319	85060	201; 283
78832	262	79237	208	79500	225; 367	79990	235	81370	178	82032	268	82684	319	85080	201; 283
78833	262	79238	209	79501	225; 367	79991	235	81371	178	82200	195	82685	319	85090	201; 283
78834	262	79248	217	79550	229; 368	79992	235	81372	178	82201	195	82687	319	85100	201; 283
78835	262	79249	217	79552	229; 368	79993	235	81373	178	82205	195	82699	189; 323	85112	201; 283
78852	212	79252	210	79570	231	79994	235	81374	178	82206	196	82705	190; 323	85113	201; 283
78870	283	79253	210	79572	231	79996	235	81378	178	82209	195	82706	190; 323	85114	201; 283
78871	228; 283	79255	208	79580	231	79997	235	81379	178	82210	196	82712	190; 323	85115	201; 283
78873	218; 284	79256	231	79600	231	79998	235	81380	178	82225	196	82713	190; 323	85116	201; 283
78910	113; 212	79261	228	79620	231	80001	235	81387	178	82231	196	82714	190; 324	85118	201; 283
78911	112; 224	79309	209	79630	231	80002	235	81390	178	82232	196	82715	190; 323	85119	201; 283
78912	112; 220	79314	222	79640	232	80012	191	81391	178	82233	196	82716	190; 324	85120	201; 283
78945	222	79318	223	79641	232	80022	191	81399	178	82234	196	82717	190; 324	85122	201; 282
78950	209	79320	217	79764	211	80032	191	81400	178	82300	199	82719	189; 323	85123	201; 282
78960	207	79324	223	79766	218	80042	191	81401	178	82301	199	82720	189; 323	85124	201; 282
78970	207	79325	223	79800	231	80052	191	81490	177	82304	199	82724	190; 324	85125	201; 282
78971	207	79327	218	79861	367	80062	191	81491	177	82305	199	82726	191; 324	85126	201; 282
78973	207	79328	218	79862	367	80072	191	81492	177	82308	199	82728	189; 322	85128	201; 282
78975	207	79329	210	79863	367	80082	191	81500	177	82310	199	82730	191; 324	85129	201; 282
78976	207	79332	217	79865	368	80111	192	81501	177	82315	199	82731	191; 324	85130	201; 282
78977	207	79334	223	79866	368	80120	192	81502	177	82320	199	82735	191; 324	86700	285
78978	207	79346	232	79867	368	80121	192	81519	178	82331	200	82742	191; 324	86701	285
78979	207	79350	228	79869	368	80220	192	81520	178	82341	200	82771	321	86750	114
78980	207	79351	228	79880	225; 343	80233	192	81521	178	82343	201	82772	321	86751	114
78981	215	79353	212	79890	225; 342	80252	192	81522	178	82351	200	82786	320	86752	114
78982	215	79354	219	79891	225; 342	80271	192	81523	178	82355	67	82787	321	86760	114
78983	215	79355	224	79892	225; 342	80300	192	81524	178	82360	199	82788	320	86761	114
78985	215	79358	228	79893	225; 342	80307	193	81525	178	82370	199	82789	320	86770	114
78986	215	79365	218	79894	225; 342	80308	193	81527	178	82372	200	82790	320	86771	114
78987	215	79366	218	79896	225; 342	80309	193	81553	177	82373	200	82791	320	87301	286
79002	214	79367	218	79898	225; 342	80312	193	81556	177	82374	200	82795	320	87302	286
79004	221	79368	218	79899	225; 342	80320	193	81560	177	82375	200	82796	320	87303	286
79005	214	79373	224	79903	213; 342	80330	193	81562	177	82377	200	82798	320	87305	286
79007	214	79374	224	79904	213; 342	80340	193	81617	172	82378	200	82800	322	87307	286
79012	214	79376	219	79905	213; 342	80350	193	81618	172	82379	200	82841	321	87311	286
79013	206	79377	219	79906	213; 342	80402	193	81637	172	82380	200	82842	321	87312	286
79015	221	79378	219	79907	213; 342	80412	193	81638	172	82384	200	82843	321	87313	286

No.	Page	No.	Page	No.	Page	No.	Page	No.	Page	No.	Page	No.	Page	No.	Page
87315	286	88550	191; 325	89113	333	89256	337	89424	230; 369	89553	341	99315	346	GV-0631	174
87317	286	88670	325	89120	335	89260	339	89425	230; 369	89560	155; 376	99351	339	GV-0656	174
87321	286	88671	325	89180	336	89261	338	89426	230; 369	89561	155; 376	99390	359	GV-0658	174
87322	286	88672	325	89181	337	89262	338	89441	229; 368	89562	155; 376	99391	359	GV-0700	174
87323	286	88673	325	89187	334	89263	338	89442	229; 368	89563	155; 376	99400	357	GV-0710	174
87325	286	88674	325	89189	335	89265	339	89443	229; 368	89564	155; 376	99401	359	GV-0720	174
87327	286	88675	325	89190	336	89266	339	89444	229; 368	89880	352	99402	362	GV-0730	175
87331	286	88676	326	89191	337	89267	339	89445	229; 368	99005	346	99403	362	GV-0740	175
87332	286	88700	375	89192	336	89268	339	89452	229; 369	99006	347	99404	362	GV-0861	175
87333	286	88701	375	89193	335	89269	339	89453	229; 369	99007	347	99405	363	GV-0871	175
87335	286	88702	375	89194	335	89270	338	89454	229; 369	99008	347	99406	363	GV-0925	175
87337	286	88703	375	89195	336	89272	338	89456	230; 369	99011	351	99407	363	GV-1100	175
87351	287	88704	375	89200	334	89273	339	89457	230; 369	99012	351	99408	362	GV-1101	175
87352	287	88705	375	89201	334	89280	340	89458	230; 369	99013	352	99409	363	GV-1102	175
87353	287	88801	375	89202	334	89281	334	89459	230; 369	99020	350	99410	362	GV-1105	175
87354	287	88805	375	89203	337	89282	334	89462	230; 369	99021	351	99412	363	GV-1121	175
87361	287	88806	375	89204	337	89298	340	89463	230; 369	99023	351	99413	363	GV-1122	175
87362	287	88809	376	89206	337	89299	340	89464	230; 369	99024	351	99415	362	GV-1123	175
87363	287	88811	376	89207	337	89300	340	89465	230; 369	99025	351	99416	362	GV-1150	176
87364	287	89000	376	89208	337	89302	340	89466	230; 369	99026	351	99418	363	GV-1151	176
87371	287	89001	330	89209	336	89303	340	89467	230; 369	99027	351	99419	363	GV-1152	176
87372	287	89002	330	89210	335	89305	340	89470	230; 369	99028	353	99420	362	GV-1160	176
87373	287	89003	330	89211	336	89307	340	89471	230; 369	99033	352	99425	363	GV-1161	176
87374	287	89004	330	89213	335	89308	340	89472	230; 369	99047	350	99426	363	GV-1180	176
87381	287	89007	331	89214	335	89310	340	89473	230; 369	99048	350	99427	364	GV-1181	176
87382	287	89008	331	89215	336	89311	340	89474	230; 369	99049	350	99428	364	GV-1182	176
87383	287	89011	331	89218	338	89312	340	89475	230; 369	99050	350	99429	364	GV-1200	176
87384	287	89013	332	89220	336	89313	340	89478	230; 370	99051	350	99430	364	GV-1201	176
87391	287	89015	332	89221	330	89314	340	89479	230; 370	99052	350	99435	364	GV-1202	176
87392	287	89017	333	89222	330	89315	340	89480	230; 370	99053	352	99436	364	GV-1220	176
87393	287	89018	333	89223	330	89316	340	89481	230; 370	99054	352	99438	364	GV-1221	176
87401	287	89020	333	89224	330	89318	340	89482	230; 370	99055	353	99440	364	GV-1240	176
87402	287	89022	334	89225	330	89319	340	89483	230; 370	99103	345	99442	364	GV-1241	176
87403	287	89070	330	89226	330	89320	340	89484	230; 370	99109	345	99443	364	GV-1242	176
87411	287	89071	330	89227	330	89330	340	89485	230; 370	99110	346	99444	364	GV-1272	176
87412	287	89072	330	89228	330	89331	340	89486	230; 370	99111	346	99445	364	GV-1382	177
87413	287	89073	330	89229	331	89335	341	89490	376	99112	346	99446	364	GV-1384	177
87422	287	89074	331	89230	331	89336	341	89507	364	99115	346	99512	379	GV-1385	177
87423	287	89075	331	89231	331	89342	341	89508	364	99116	346	99513	379	GV-1386	177
87425	287	89076	332	89232	331	89345	341	89509	364	99180	345	99514	379	GV-1387	177
87427	287	89077	332	89233	331	89348	341	89515	364	99181	345	99519	379	GV-1388	177
87431	288	89078	333	89234	331	89351	337	89518	364	99182	345	99520	379	GV-1582	176
87432	288	89079	333	89235	332	89390	338	89520	364	99190	344	99568	380	GV-1583	176
87433	288	89080	332	89236	332	89401	229; 368	89525	365	99191	345	99575	380		
87435	288	89083	333	89239	331	89402	229; 368	89526	365	99193	343	99576	380		
87437	288	89090	335	89240	331	89403	229; 368	89528	365	99194	343	99580	379		
87445	288	89100	330	89241	332	89404	229; 368	89536	365	99202	344	99581	380		
87447	288	89101	330	89242	332	89405	229; 368	89537	365	99203	344	99584	380		
87451	288	89102	330	89243	333	89406	229; 368	89538	365	99204	344	99640	378		
87452	288	89103	330	89244	333	89411	229; 369	89539	365	99207	344	99641	378		
87453	288	89104	331	89245	333	89412	229; 369	89540	365	99208	344	GV-0062	173		
87454	288	89105	331	89246	333	89413	229; 369	89541	365	99209	344	GV-0082	173		
87455	288	89106	332	89247	334	89414	229; 369	89542	366	99210	345	GV-0083	173		
87456	288	89107	332	89248	334	89415	229; 369	89543	366	99230	344	GV-0400	173		
87457	288	89108	333	89251	332	89416	229; 369	89545	366	99240	345	GV-0420	173		
88411	266; 326	89109	333	89252	332	89421	230; 369	89546	366	99300	347	GV-0510	174		
88421	266; 326	89110	332	89253	331	89422	230; 369	89547	366	99301	347	GV-0610	174		
88422	266; 326	89112	334	89255	337	89423	230; 369	89552	341	99310	346	GV-0620	174		

## PL

I. TOYA S.A. informuje, iż:

- 1) niniejszy katalog nie stanowi oferty w rozumieniu prawa cywilnego;
- 2) prezentowane w niniejszym katalogu artykuły mogą w rzeczywistości odbiegać od wskazanego na zdjęciach wzoru, w szczególności jeżeli chodzi o cechy zewnętrzne, tj. wielkość, kolor, sposób opakowania, ilość przedmiotów w opakowaniu;
- 3) nie ponosi odpowiedzialności za drobne różnice w sposobie pakowania czy właściwościach artykułów pozostających bez wpływu na jego przeznaczony cel lub sposób użytkowania;
- 4) nie ponosi odpowiedzialności wynikającej z jakichkolwiek niedokładności lub nieścisłości, co do informacji zawartych w przedmiotowym katalogu;
- 5) nie ponosi odpowiedzialności za ewentualną szkodę powstałą w wyniku otrzymania towaru o innych właściwościach niż prezentowany na zdjęciach.

II. Pomimo najlepszych starań poczynionych przez TOYA S.A. nie może ona zagwarantować, iż informacje zawarte w niniejszym katalogu w pełni odpowiadają rzeczywistości.

III. Wszelkie decyzje podjęte na podstawie informacji zawartych w przedmiotowym katalogu podejmowane są na własne ryzyko osoby, która korzysta z tych informacji.

## GB

I. TOYA S.A. informs that:

- 1) the present catalogue does not constitute an offer as construed in the civil law;
- 2) the goods presented in the present catalogue may in fact differ from the models shown in the pictures, particularly as far as external properties are concerned, namely size, colour, packaging, number of items in the package;
- 3) the company will not be held responsible for small differences in packaging or properties of the goods, which do not affect the purpose or the exploitation of the tools;
- 4) the company will not be held responsible for any inaccuracies or imprecision regarding the information presented in the catalogue;
- 5) the company will not be held responsible for any damage caused by goods whose properties differ from those of the tools presented in the photographs.

II. In spite of all the efforts made by TOYA S.A., the company cannot guarantee the information contained in the present catalogue fully correspond to the reality.

III. Any decisions made on the basis of the information contained in the present catalogue will be made at the risk of the person who makes them using the aforementioned information.

## D

I. TOYA S.A. informiert, dass:

- 1) der vorliegende Katalog kein Angebot im zivilrechtlichen Sinne darstellt;
- 2) die im vorliegenden Katalog präsentierten Artikel in der Realität von den auf den Musterfotos gezeigten abweichen können, und zwar besonders dann, wenn es um äußere Eigenschaften geht, wie z.B. Größe, Farbe, Art der Verpackung, Anzahl der Gegenstände in der Verpackung;
- 3) sie keine Verantwortung für geringfügige Unterschiede bei der Verpackungsart oder den Eigenschaften der Artikel übernimmt, die ohne Auswirkungen auf seinen Bestimmungszweck oder die Art der Nutzung bleiben;
- 4) sie keine Verantwortung für irgendwelche Oberflächlichkeiten und Ungenauigkeiten bzgl. der im Sachkatalogkatalog enthaltenen Informationen übernimmt;
- 5) sie keine Verantwortung für eventuelle Schäden, die im Ergebnis des Erhalts der Ware mit anderen als auf den Fotos dargestellten Eigenschaften entstanden sind, übernimmt.

II. Trotz großer Bemühungen seitens TOYA S.A. kann die Firma nicht garantieren, dass die im vorliegenden Katalog enthaltenen Informationen voll der Realität entsprechen.

III. Sämtliche Entscheidungen, die auf der Grundlage der im Sachkatalog enthaltenen Informationen getroffen wurden, gehen auf das Risiko der Person, die diese Informationen benutzt.

## RUS

I. TOYA S.A. заявляет:

- 1) настоящий каталог не является торговым предложением с точки зрения гражданского законодательства;
- 2) изделия, представленные в настоящем каталоге, могут отличаться от образцов на снимках, особенно внешним видом, то есть размером, цветом, способом упаковки, количеством предметов в упаковке;
- 3) производитель не отвечает за мелкие отличия в способе упаковки или свойствах изделий, которые не влияют на предназначение или способ пользования изделиями;
- 4) производитель не отвечает за мелкие неточности в сведениях из предметного каталога;
- 5) производитель не отвечает за ущерб, нанесенный вследствие поставки товара, отличающегося параметрами от указанного на снимках.

II. Несмотря на все усилия в данном направлении, компания TOYA S.A. не гарантирует, что информация, метящаяся в настоящем каталоге, полностью отвечает действительности.

III. Риск, связанный с любыми решениями, принятыми на основании информации из предметного каталога, берут на себя лица, пользующиеся указанной информацией.

## UA

I. Інформація від виробника, TOYA S.A.:

- 1) цей каталог не є комерційною пропозицією з точки зору цивільного законодавства;
  - 2) вироби, представлені у цьому каталозі, можуть відрізнятися від зображень на фотографіях, особливо зовнішнім виглядом, тобто розміром, кольором, способом упаковки, кількістю предметів в упаковці;
  - 3) виробник не несе відповідальність за дрібні відмінності у способі упаковки чи властивостях виробів, які не мають впливу на їх призначення чи спосіб користування ними;
  - 4) виробник не несе відповідальність за дрібні неточності у інформації, включеної у цей каталог;
  - 5) виробник не несе відповідальність за можливі збитки, нанесені внаслідок отримання виробів, що своїми параметрами відрізняються від зображень на фотографіях.
- II. Незважаючи на зусилля у даному напрямку, фірма TOYA S.A. не гарантує, що інформація, включена у цей каталог, повністю відповідає дійсності.

III. Приймаючи будь-які рішення на підставі інформації, включеної у цей каталог, не забувайте, що пов'язаний з ними ризик беруть на себе особи, що використовують включену у каталог інформацію.

## LT

I. TOYA S.A. informuoja, kad:

- 1) šis katalogas nėra civilinės teisės supratimu pasiūlymas;
- 2) rodomos šame kataloge prekės gali tikrumoje skirtis nuo parodyto nuotraukose pavyzdžio, ypač jų išorine išvaizda ir požymiais, t.y. dydžiu, spalva, įpakavimo būdu, elementų kiekiu pakuotėje;
- 3) gamintojas neneša atsakomybės už nereikšmingus skirtumus įpakavime arba gaminio savybėse, kurios neturi įtakos jo paskirčiai arba jo vartojimo būdui.
- 4) neneša taip pat atsakomybės dėl bet kokių netikslumų arba nepakankamai preciziškų apibrėžimų pateiktoje kataloge informacijoje.
- 5) neneša atsakomybės už galimai patirtus nuostolius gavus prekę su savybėmis, kurios nėra tapačios su pateiktomis nuotraukose.

II. Nežiūrint geriausių TOYA S.A. pastangų, bendrovė negali garantuoti, kad pateikta šiame kataloge informacija pilnai atitinka tikrovę.

III. Bet kokie sprendimai priimami šiame kataloge pateiktą informaciją pagrindu yra besinaudojančio šia informacija asmens priimami savo paties rizika.

## LV

I. A/S „TOYA” informē, ka:

- 1) šis katalogs nav piedāvājums civillikuma izpratnē;
- 2) piedāvāti šī katalogā produkti realitātē var atšķirties no rādīta uz fotogrāfijas parauga, sevišķi ārēju īpašību sfērā, t.i. ar lielumu, krāsu, pakošanas veidu, priekšmetu skaitu iepakojumā;
- 3) nav atbildīga par smalkām atšķirībām iepakošanas veidā vai produktu īpašībām, ja tie neietekmē ierīces paredzētu mērķu vai lietošanas veidu;
- 4) nav atbildīga par kaut kādām neprecizitātēm informācijās, kas ir norādītas šī katalogā;
- 5) nav atbildīga par iespējamam zaudējumam, savienotiem ar produkta saņemšanu ar citām īpašībām, nekā rādītas uz fotogrāfijas.

II. Neskatoties uz visaugstāko rūpību, ar kuru A/S „TOYA” sagatavoja savu katalogu, tā nevar garantēt, ka informācijas šī katalogā pilnīgi atbild realitātei.

III. Visi lēmumi, pieņemti pamatojoties uz informāciju no kataloga - ir pieņemti uz personas, kura lieto šo informāciju, risku.

## CZ

I. TOYA S.A. informuje že:

- 1) tento katalog nepředstavuje nabídku ve smyslu občanského práva;
- 2) výrobky prezentované v tomto katalogu se mohou ve skutečnosti lišit od modelů uvedených na obrázcích, zejména co se týká vnějších znaků, tj. velikosti, barvy, způsobu balení, počtu předmětů v balení;
- 3) nenese odpovědnost za drobné rozdíly ve způsobu balení nebo ve vlastnostech výrobků, které nemají zásadní vliv na jejich určený účel nebo způsob používání;
- 4) nenese odpovědnost vyplývající z jakýchkoli nepřesností co do informací uvedených v předmětném katalogu;
- 5) nenese odpovědnost za případné škody vzniklé v důsledku obdržení zboží s jinými vlastnostmi, než je uvedeno na obrázcích.

II. Navzdory mimořádnému úsilí vynaloženému firmou TOYA S.A. tato nemůže garantovat, zda informace uvedené v tomto katalogu zcela odpovídají skutečnosti.

III. Veškerá rozhodnutí přijatá na základě informací uvedených v předmětném katalogu jsou přijímána na vlastní riziko osoby, která tyto informace využívá.

## SK

I. TOYA S.A. informuje že:

- 1) tento katalóg nepredstavuje ponuku v zmysle občianskeho práva;

- 2) výrobky prezentované v tomto katalógu sa v skutočnosti môžu líšiť od modelov zobrazených na obrázkoch, najmä pokiaľ sa jedná o vonkajšie znaky, t.j. veľkosť, farbu, spôsob balenia, počet predmetov v balení;
- 3) nenesie zodpovednosť za drobné rozdiely v spôsobe balenia či vlastnostiach výrobkov, ktoré nemajú zásadný vplyv na ich určený účel alebo spôsob používania;
- 4) nenesie zodpovednosť vyplývajúcu z akejkoľvek nepresnosti týkajúcej sa informácií uvedených v predmetnom katalógu;
- 5) nenesie zodpovednosť za prípadné škody vzniknuté v dôsledku obdržania tovaru s inými vlastnosťami, než je uvedené na obrázkoch.

II. Aj napriek mimoriadnemu úsiliu zo strany firmy TOYA S.A. táto nemôže garantovať, či informácie uvedené v tomto katalógu plne zodpovedajú skutočnosti.

III. Všetky rozhodnutia prijaté na základe informácií uvedených v predmetnom katalógu sú prijímané na vlastné riziko osoby, ktorá tieto informácie využíva.

## H

I. A TOYA S.A. tájékoztatja, hogy:

- 1) a jelen katalógus a polgári jog szerinti nem kereskedelmi ajánlat;
  - 2) a jelen katalógusban bemutatott árucikkek a valóságban eltérhetnek a képeken látható mintától, különösen a külső tulajdonságok, mint a méret, szín, csomagolási mód, a csomagban lévő tárgyak száma tekintetében;
  - 3) nem vállal felelősséget a csomagolás módjában vagy az árucikkek olyan tulajdonságaiban történő változtatásokért, amelyek nem befolyásolják lényeges módon annak rendeltetését vagy a felhasználás módját;
  - 4) nem vállal felelősséget a jelen katalógusban lévő információk pontatlanságáért;
  - 5) nem vállal felelősséget azokért az esetleges károkért, amik az árucikkek a fényképeken látható tulajdonságoktól eltérő tulajdonságokkal történő leszállításából erednek.
- II. A TOYA S.A. minden igyekezete ellenére nem tudja garantálni, hogy a jelen katalógusban

található információk teljes egészében megfelelnek a valóságnak.

III. A tárgyi katalógusban található információk alapján meghozott bármilyen döntés annak a személynek a rizikója, aki ezeket az információkat felhasználja.

## RO

I. TOYA S.A. informează că:

- 1) prezentul catalog nu constituie ofertă în înțelesul dreptului civil;
- 2) articolele prezentate în prezentul catalog se pot diferi față de mostrele din fotografiile, în special aspectul exterior, adică mărimea, culoarea, modul de ambalare, cantitatea obiectelor în ambalaj;
- 3) nu-și asumă răspunderea referitor la mici diferențe la modul de ambalare sau la articole al căror proprietăți nu au influență referitor la destinația sau modul lor de utilizare;
- 4) nu-și asumă răspunderea referitor la orice inexactitate sau imprecizie, datorită informațiilor cuprinse în catalogul respectiv;
- 5) nu-și asumă răspunderea referitor la o eventuală pagubă ca urmare a primirii marfei cu alte proprietăți decât cele prezentate pe fotografii;

II. Cu toate strădanile TOYA S.A., firma nu poate garanta că, informațiile din prezentul catalog corespund realității;

III. Orice decizie preluată în baza informațiilor cuprinse în catalogul respectiv, sunt preluate pe riscul și răspunderea persoanei care a făcut folos de aceste informații.

## E





I. TOYA S.A. comunica lo siguiente:

- 1) el presente catálogo no constituye una oferta, en el sentido que la noción adquiere en la ley civil;
- 2) los artículos presentados en el presente catálogo pueden en realidad diferir de los modelos indicados en las fotografías, especialmente en cuanto a sus propiedades externas, es decir el tamaño, el color, el empaque o la cantidad de los objetos en el empaque;
- 3) la empresa no se hace responsable por pequeñas diferencias en cuanto al empaque o las propiedades de los artículos, siempre y cuando estas diferencias no afectan el propósito o el modo de operación de las herramientas;
- 4) la empresa no se hace responsable por ninguna imprecisión en cuanto a la información presentada en el presente catálogo;
- 5) la empresa no se hace responsable por ningún daño que surja del hecho de que los artículos recibidos difieran de los artículos presentados en las fotografías en cuanto a sus propiedades.

II. A pesar de los mejores intentos de parte TOYA S.A. la empresa no puede garantizar que la información presentada en el presente catálogo corresponda completamente a la realidad.

III. Todas las decisiones tomadas en base a la información presentada en el presente son responsabilidad de la persona que recurra a la dicha información.



	Colour box		Sleeve
	Box with colour label		Carton envelope
	PVC colour box		Bulk
	Box		Plastic holder
	Display colour box		Flag tied on card
	Hanging colour box		Metal box
	Blister card		Metal box with colour label
	Double blister card		Metal box with sleeve
	Double blister transparent		Plastic box
	Half double blister card		Plastic box with colour sleeve
	Sliding card		Plastic case with colour label
	Plastic hanger		Plastic case with label
	Hanging card		Plastic case with colour sleeve
	Header card		Plastic tube with colour label
	Tied on card		Metal clip
	Skin card		Wooden box with sleeve
	Polybag with header card		Pouch
	Polybag		Shrink card / Plastic tray
	Polybag with printed header		
	Polybag with hanger		



PRESSURE SPRAYERS / OPRYSKIWACZE CIŚNIENIOWE

FLO

89507 1.0 L

89508 1.5 L

89509 2.0 L



FLO

89515 5.0 L

89518 8.0 L



FLO

89520 8.0 L





MANUFACTURER / PRODUCENT

TOYA SA  
ul. Soltysovicka 13-15  
51-168 Wrocław  
☎ (+48 71) 32 46 200  
fax: (+48 71) 32 46 370

sales@yato.pl (sale)  
export@yato.pl (export)  
import@yato.pl (import)

ODDZIAŁ WARSZAWSKI  
Teren ProLogis Park Nadarzyn  
al. Kasztanowa 160  
05-831 Młochów k. Warszawy

☎ (+48 22) 73 82 800  
☎ (+48 22) 73 82 828  
sales@yato.pl (sale)  
export@yato.pl (export)

TOYA ROMANIA SA  
Sos. Odăi Nr. 109-123  
Sector 1, București  
☎ 0040 031 710 8692 office@yato.ro

YATO TOOLS (SHANGHAI) Co.,Ltd  
No. 8 Lane 1300,  
East KangQiao Road,  
201315 Shanghai, China  
☎ (+86 21) 20981106  
fax: +86 21 20981108  
yato@yato-sh.com



YOUR TRUSTED SUPPLIER: / TWÓJ ZAUFANY DOSTAWCA:

GET ACQUAINTED WITH OUR WIDE OFFER/  
ZOBACZ NASZĄ BOGATĄ OFERTĘ:



Copyright © TOYA S.A.